

User's Manual

NEC

VR4181™

64-/32-bit Microprocessor

μPD30181

Document No. U14272EJ1V0UMJ1 (1st edition)
Date Published September 2000 NS CP(K)

© NEC Corporation 2000
© MIPS Technologies, Inc. 1998
Printed in Japan

[MEMO]

NOTES FOR CMOS DEVICES

① PRECAUTION AGAINST ESD FOR SEMICONDUCTORS

Note:

Strong electric field, when exposed to a MOS device, can cause destruction of the gate oxide and ultimately degrade the device operation. Steps must be taken to stop generation of static electricity as much as possible, and quickly dissipate it once, when it has occurred. Environmental control must be adequate. When it is dry, humidifier should be used. It is recommended to avoid using insulators that easily build static electricity. Semiconductor devices must be stored and transported in an anti-static container, static shielding bag or conductive material. All test and measurement tools including work bench and floor should be grounded. The operator should be grounded using wrist strap. Semiconductor devices must not be touched with bare hands. Similar precautions need to be taken for PW boards with semiconductor devices on it.

② HANDLING OF UNUSED INPUT PINS FOR CMOS

Note:

No connection for CMOS device inputs can be cause of malfunction. If no connection is provided to the input pins, it is possible that an internal input level may be generated due to noise, etc., hence causing malfunction. CMOS devices behave differently than Bipolar or NMOS devices. Input levels of CMOS devices must be fixed high or low by using a pull-up or pull-down circuitry. Each unused pin should be connected to V_{DD} or GND with a resistor, if it is considered to have a possibility of being an output pin. All handling related to the unused pins must be judged device by device and related specifications governing the devices.

③ STATUS BEFORE INITIALIZATION OF MOS DEVICES

Note:

Power-on does not necessarily define initial status of MOS device. Production process of MOS does not define the initial operation status of the device. Immediately after the power source is turned ON, the devices with reset function have not yet been initialized. Hence, power-on does not guarantee out-pin levels, I/O settings or contents of registers. Device is not initialized until the reset signal is received. Reset operation must be executed immediately after power-on for devices having reset function.

VR4000, VR4000 Series, VR4100, VR4100 Series, VR4102, VR4110, VR4111, VR4181, VR4300, VR4305, VR4310, VR4400, and Vr Series are trademarks of NEC Corporation.

MIPS is a registered trademark of MIPS Technologies, Inc. in the United States.

UNIX is a registered trademark in the United States and other countries, licensed exclusively through X/Open Company, Ltd.

StrataFlash is a trademark of Intel Corp.

Exporting this product or equipment that includes this product may require a governmental license from the U.S.A. for some countries because this product utilizes technologies limited by the export control regulations of the U.S.A.

- **The information in this document is current as of June, 2000. The information is subject to change without notice. For actual design-in, refer to the latest publications of NEC's data sheets or data books, etc., for the most up-to-date specifications of NEC semiconductor products. Not all products and/or types are available in every country. Please check with an NEC sales representative for availability and additional information.**
 - No part of this document may be copied or reproduced in any form or by any means without prior written consent of NEC. NEC assumes no responsibility for any errors that may appear in this document.
 - NEC does not assume any liability for infringement of patents, copyrights or other intellectual property rights of third parties by or arising from the use of NEC semiconductor products listed in this document or any other liability arising from the use of such products. No license, express, implied or otherwise, is granted under any patents, copyrights or other intellectual property rights of NEC or others.
 - Descriptions of circuits, software and other related information in this document are provided for illustrative purposes in semiconductor product operation and application examples. The incorporation of these circuits, software and information in the design of customer's equipment shall be done under the full responsibility of customer. NEC assumes no responsibility for any losses incurred by customers or third parties arising from the use of these circuits, software and information.
 - While NEC endeavours to enhance the quality, reliability and safety of NEC semiconductor products, customers agree and acknowledge that the possibility of defects thereof cannot be eliminated entirely. To minimize risks of damage to property or injury (including death) to persons arising from defects in NEC semiconductor products, customers must incorporate sufficient safety measures in their design, such as redundancy, fire-containment, and anti-failure features.
 - NEC semiconductor products are classified into the following three quality grades:
"Standard", "Special" and "Specific". The "Specific" quality grade applies only to semiconductor products developed based on a customer-designated "quality assurance program" for a specific application. The recommended applications of a semiconductor product depend on its quality grade, as indicated below. Customers must check the quality grade of each semiconductor product before using it in a particular application.
 - "Standard": Computers, office equipment, communications equipment, test and measurement equipment, audio and visual equipment, home electronic appliances, machine tools, personal electronic equipment and industrial robots
 - "Special": Transportation equipment (automobiles, trains, ships, etc.), traffic control systems, anti-disaster systems, anti-crime systems, safety equipment and medical equipment (not specifically designed for life support)
 - "Specific": Aircraft, aerospace equipment, submersible repeaters, nuclear reactor control systems, life support systems and medical equipment for life support, etc.
- The quality grade of NEC semiconductor products is "Standard" unless otherwise expressly specified in NEC's data sheets or data books, etc. If customers wish to use NEC semiconductor products in applications not intended by NEC, they must contact an NEC sales representative in advance to determine NEC's willingness to support a given application.
- (Note)
- (1) "NEC" as used in this statement means NEC Corporation and also includes its majority-owned subsidiaries.
 - (2) "NEC semiconductor products" means any semiconductor product developed or manufactured by or for NEC (as defined above).

M8E 00.4

Regional Information

Some information contained in this document may vary from country to country. Before using any NEC product in your application, please contact the NEC office in your country to obtain a list of authorized representatives and distributors. They will verify:

- Device availability
- Ordering information
- Product release schedule
- Availability of related technical literature
- Development environment specifications (for example, specifications for third-party tools and components, host computers, power plugs, AC supply voltages, and so forth)
- Network requirements

In addition, trademarks, registered trademarks, export restrictions, and other legal issues may also vary from country to country.

NEC Electronics Inc. (U.S.)

Santa Clara, California
Tel: 408-588-6000
800-366-9782
Fax: 408-588-6130
800-729-9288

NEC Electronics (Germany) GmbH

Duesseldorf, Germany
Tel: 0211-65 03 02
Fax: 0211-65 03 490

NEC Electronics (UK) Ltd.

Milton Keynes, UK
Tel: 01908-691-133
Fax: 01908-670-290

NEC Electronics Italiana s.r.l.

Milano, Italy
Tel: 02-66 75 41
Fax: 02-66 75 42 99

NEC Electronics (Germany) GmbH

Benelux Office
Eindhoven, The Netherlands
Tel: 040-2445845
Fax: 040-2444580

NEC Electronics (France) S.A.

Velizy-Villacoublay, France
Tel: 01-30-67 58 00
Fax: 01-30-67 58 99

NEC Electronics (France) S.A.

Madrid Office
Madrid, Spain
Tel: 91-504-2787
Fax: 91-504-2860

NEC Electronics (Germany) GmbH

Scandinavia Office
Taeby, Sweden
Tel: 08-63 80 820
Fax: 08-63 80 388

NEC Electronics Hong Kong Ltd.

Hong Kong
Tel: 2886-9318
Fax: 2886-9022/9044

NEC Electronics Hong Kong Ltd.

Seoul Branch
Seoul, Korea
Tel: 02-528-0303
Fax: 02-528-4411

NEC Electronics Singapore Pte. Ltd.

United Square, Singapore
Tel: 65-253-8311
Fax: 65-250-3583

NEC Electronics Taiwan Ltd.

Taipei, Taiwan
Tel: 02-2719-2377
Fax: 02-2719-5951

NEC do Brasil S.A.

Electron Devices Division
Guarulhos-SP Brasil
Tel: 55-11-6462-6810
Fax: 55-11-6462-6829

J00.7

[MEMO]

PREFACE

- Readers** This manual targets users who intend to understand the functions of the VR4181 and to design application systems using this microprocessor.
- Purpose** This manual introduces the architecture and hardware functions of the VR4181 to users, following the organization described below.
- Organization** This manual consists of the following contents:
- Introduction
 - Pipeline operation
 - Cache organization and memory management system
 - Exception processing
 - Initialization interface
 - Interrupts
 - Peripheral units
 - Instruction set details
- How to read this manual** It is assumed that the reader of this manual has general knowledge in the fields of electric engineering, logic circuits, and microcomputers.
- The VR4000™ in this manual includes the VR4400™.
- To learn in detail about the function of a specific instruction,
→ Read **CHAPTER 3 MIPS™ III INSTRUCTION SET SUMMARY, CHAPTER 4 MIPS16 INSTRUCTION SET, CHAPTER 27 MIPS III INSTRUCTION SET DETAILS, and CHAPTER 28 MIPS16 INSTRUCTION SET FORMAT.**
- To learn about the overall functions of the VR4181,
→ Read this manual in sequential order.
- To learn about electrical specifications,
→ Refer to **Data Sheet** which is separately available.
- Conventions**
- | | |
|-------------------------|---|
| Data significance: | Higher on left and lower on right |
| Active low: | XXX# (trailing # after pin and signal names) |
| Note: | Description of item marked with Note in the text |
| Caution: | Information requiring particular attention |
| Remark: | Supplementary information |
| Numeric representation: | binary/decimal ... XXXX
hexadecimal ... 0XXXXX |
- Prefixes representing an exponent of 2 (for address space or memory capacity):
- | | |
|----------|-------------------|
| K (kilo) | $2^{10} = 1024$ |
| M (mega) | $2^{20} = 1024^2$ |
| G (giga) | $2^{30} = 1024^3$ |
| T (tera) | $2^{40} = 1024^4$ |
| P (peta) | $2^{50} = 1024^5$ |
| E (exa) | $2^{60} = 1024^6$ |

Related Documents

The related documents indicated here may include preliminary version. However, preliminary versions are not marked as such.

- User's manual
VR4181 User's Manual This manual
- Data sheet
 μ PD30181 (VR4181) Data Sheet U14273E

CONTENTS

CHAPTER 1 INTRODUCTION	31
1.1 Features	31
1.2 Ordering Information	32
1.3 VR4181 Key Features	32
1.3.1 CPU core	33
1.3.2 Bus interface	33
1.3.3 Memory interface	34
1.3.4 DMA controller (DCU)	34
1.3.5 Interrupt controller (ICU)	34
1.3.6 Real-time clock	34
1.3.7 Audio output (D/A converter)	34
1.3.8 Touch panel interface and audio input (A/D converter)	34
1.3.9 CompactFlash interface (ECU)	34
1.3.10 Primary serial interface (SIU1)	34
1.3.11 Secondary serial interface (SIU2)	34
1.3.12 Clocked serial interface (CSI)	35
1.3.13 Keyboard interface (KIU)	35
1.3.14 General-purpose I/O	35
1.3.15 Programmable chip selects	36
1.3.16 LCD interface	36
1.3.17 Wake-up events	37
1.4 VR4110 CPU Core	37
1.4.1 CPU registers	39
1.4.2 Coprocessors	40
1.4.3 Floating-point unit (FPU)	42
1.4.4 CPU core memory management unit	42
1.4.5 Translation lookaside buffer (TLB)	42
1.4.6 Operating mode	42
1.4.7 Cache	43
1.5 Instruction Pipeline	43
1.6 Clock Interface	43
CHAPTER 2 PIN FUNCTIONS	45
2.1 Pin Configuration	45
2.2 Pin Function Description	47
2.2.1 System bus interface signals	47
2.2.2 LCD interface signals	49
2.2.3 Initialization interface signals	50
2.2.4 Battery monitor interface signals	50
2.2.5 Clock interface signals	50
2.2.6 Touch panel interface and audio interface signals	51
2.2.7 LED interface signals	51
2.2.8 CompactFlash interface and keyboard interface signals	51

2.2.9 Serial interface 1 signals	52
2.2.10 IrDA interface signals	52
2.2.11 General-purpose I/O signals	53
2.2.12 Dedicated V _{DD} /GND signals	54
2.3 Pin Status in Specific Status	55
CHAPTER 3 MIPS III INSTRUCTION SET SUMMARY	59
3.1 CPU Instruction Formats	59
3.2 Instruction Classes	60
3.2.1 Load and store instructions	60
3.2.2 Computational instructions	64
3.2.3 Jump and branch instructions	70
3.2.4 Special instructions	74
3.2.5 System control coprocessor (CP0) instructions	75
CHAPTER 4 MIPS16 INSTRUCTION SET	77
4.1 Outline	77
4.2 Features	77
4.3 Register Set	78
4.4 ISA Mode	79
4.4.1 Changing ISA mode bit by software	79
4.4.2 Changing ISA mode bit by exception	79
4.4.3 Enabling change ISA mode bit	80
4.5 Types of Instructions	80
4.6 Instruction Format	82
4.7 MIPS16 Operation Code Bit Encoding	87
4.8 Outline of Instructions	90
4.8.1 PC-relative instructions	90
4.8.2 Extend instruction	91
4.8.3 Delay slots	93
4.8.4 Instruction details	94
CHAPTER 5 VR4181 PIPELINE	107
5.1 Pipeline Stages	107
5.1.1 Pipeline activities	108
5.2 Branch Delay	110
5.3 Load Delay	110
5.4 Pipeline Operation	110
5.5 Interlock and Exception Handling	117
5.5.1 Exception conditions	120
5.5.2 Stall conditions	121
5.5.3 Slip conditions	122
5.5.4 Bypassing	124
5.6 Code Compatibility	124

CHAPTER 6 MEMORY MANAGEMENT SYSTEM	125
6.1 Translation Lookaside Buffer (TLB)	125
6.2 Virtual Address Space	125
6.2.1 Virtual-to-physical address translation	126
6.2.2 32-bit mode address translation	127
6.2.3 64-bit mode address translation	128
6.2.4 Operating modes	129
6.2.5 User mode virtual addressing	129
6.2.6 Supervisor mode virtual addressing	131
6.2.7 Kernel mode virtual addressing	134
6.3 Physical Address Space	142
6.3.1 ROM space	143
6.3.2 External system bus space	143
6.3.3 Internal I/O space	144
6.3.4 DRAM space	145
6.4 System Control Coprocessor	146
6.4.1 Format of a TLB entry	147
6.5 CP0 Registers	148
6.5.1 Index register (0)	148
6.5.2 Random register (1)	148
6.5.3 EntryLo0 (2) and EntryLo1 (3) registers	149
6.5.4 PageMask register (5)	150
6.5.5 Wired register (6)	151
6.5.6 EntryHi register (10)	152
6.5.7 Processor revision identifier (PRId) register (15)	153
6.5.8 Config register (16)	154
6.5.9 Load linked address (LLAddr) register (17)	155
6.5.10 Cache tag registers (TagLo (28) and TagHi (29))	156
6.5.11 Virtual-to-physical address translation	157
6.5.12 TLB misses	159
6.5.13 TLB instructions	159
 CHAPTER 7 EXCEPTION PROCESSING	 161
7.1 Exception Processing Operation	161
7.2 Precision of Exceptions	162
7.3 Exception Processing Registers	163
7.3.1 Context register (4)	164
7.3.2 BadVAddr register (8)	165
7.3.3 Count register (9)	165
7.3.4 Compare register (11)	166
7.3.5 Status register (12)	166
7.3.6 Cause register (13)	169
7.3.7 Exception program counter (EPC) register (14)	171
7.3.8 WatchLo (18) and WatchHi (19) registers	172
7.3.9 XContext register (20)	173
7.3.10 Parity Error register (26)	174

7.3.11	Cache Error register (27)	174
7.3.12	ErrorEPC register (30)	175
7.4	Details of Exceptions	177
7.4.1	Exception types	177
7.4.2	Exception vector locations	177
7.4.3	Priority of exceptions	179
7.4.4	Cold Reset exception	180
7.4.5	Soft Reset exception	181
7.4.6	NMI exception	182
7.4.7	Address Error exception	183
7.4.8	TLB exceptions	184
7.4.9	Bus Error exception	187
7.4.10	System Call exception	188
7.4.11	Breakpoint exception	189
7.4.12	Coprocessor Unusable exception	190
7.4.13	Reserved Instruction exception	191
7.4.14	Trap exception	192
7.4.15	Integer Overflow exception	192
7.4.16	Watch exception	193
7.4.17	Interrupt exception	194
7.5	Exception Processing and Servicing Flowcharts	195
CHAPTER 8 INITIALIZATION INTERFACE		203
8.1	Overview	203
8.2	Reset Function	203
8.2.1	RTC reset	204
8.2.2	RSTSW	205
8.2.3	Deadman's Switch	206
8.2.4	Software shutdown	207
8.2.5	HALTimer shutdown	208
8.3	Power On Sequence	209
8.4	Reset of CPU Core	211
8.4.1	Cold Reset	211
8.4.2	Soft Reset	212
8.5	Vr4181 Processor Modes	213
8.5.1	Power modes	213
8.5.2	Privilege mode	214
8.5.3	Reverse endian	214
8.5.4	Bootstrap exception vector (BEV)	214
8.5.5	Cache error check	215
8.5.6	Parity error prohibit	215
8.5.7	Interrupt enable (IE)	215

CHAPTER 9 CACHE MEMORY	217
9.1 Memory Organization	217
9.2 Cache Organization	218
9.2.1 Organization of the instruction cache (I-cache)	218
9.2.2 Organization of the data cache (D-cache)	219
9.2.3 Accessing the caches	220
9.3 Cache Operations	221
9.3.1 Cache write policy	221
9.4 Cache States	222
9.5 Cache State Transition Diagrams	223
9.5.1 Data cache state transition	223
9.5.2 Instruction cache state transition	223
9.6 Cache Data Integrity	224
9.7 Manipulation of the Caches by an External Agent	232
CHAPTER 10 CPU CORE INTERRUPTS	233
10.1 Non-maskable Interrupt (NMI)	233
10.2 Ordinary Interrupts	233
10.3 Software Interrupts Generated in CPU Core	234
10.4 Timer Interrupt	234
10.5 Asserting Interrupts	234
10.5.1 Detecting hardware interrupts	234
10.5.2 Masking interrupt signals	236
CHAPTER 11 BUS CONTROL	237
11.1 MBA Host Bridge	237
11.1.1 MBA Host Bridge ROM and register address space	238
11.1.2 MBA modules address space	238
11.2 Bus Control Registers	239
11.2.1 BCUCNTREG 1 (0x0A00 0000)	240
11.2.2 CMUCLKMSK (0x0A00 0004)	241
11.2.3 BCUSPEEDREG (0x0A00 000C)	242
11.2.4 BCURFCNTREG (0x0A00 0010)	244
11.2.5 REVIDREG (0x0A00 0014)	245
11.2.6 CLKSPEEDREG (0x0A00 0018)	246
11.3 ROM Interface	247
11.3.1 External ROM devices memory mapping	247
11.3.2 Connection to external ROM (x 16) devices	248
11.3.3 Example of ROM connection	249
11.3.4 External ROM cycles	254
11.4 DRAM Interface	257
11.4.1 EDO DRAM configuration	257
11.4.2 Mix memory mode (EDO DRAM only)	258
11.4.3 EDO DRAM timing parameters	258
11.4.4 SDRAM configuration	259

11.5 Memory Controller Register Set	260
11.5.1 EDOMCYTREG (0x0A00 0300)	260
11.5.2 MEMCFG_REG (0x0A00 0304)	262
11.5.3 MODE_REG (0x0A00 0308)	264
11.5.4 SDTIMINGREG (0x0A00 030C)	265
11.6 ISA Bridge	266
11.7 ISA Bridge Register Set	266
11.7.1 ISABRGCTL (0x0B00 02C0)	266
11.7.2 ISABRGSTS (0x0B00 02C2)	267
11.7.3 XISACTL (0x0B00 02C4)	268
CHAPTER 12 DMA CONTROL UNIT (DCU)	271
12.1 General	271
12.2 DCU Registers	273
12.2.1 Microphone destination 1 address registers	274
12.2.2 Microphone destination 2 address registers	275
12.2.3 Speaker source 1 address registers	276
12.2.4 Speaker source 2 address registers	277
12.2.5 DMARSTREG (0x0A00 0040)	278
12.2.6 AIUDMAMSKREG (0x0A00 0046)	278
12.2.7 MICRCLNREG (0x0A00 0658)	279
12.2.8 SPKRCLNREG (0x0A00 065A)	279
12.2.9 MICDMACFGREG (0x0A00 065E)	280
12.2.10 SPKDMACFGREG (0x0A00 0660)	281
12.2.11 DMAITRQREG (0x0A00 0662)	282
12.2.12 DMACLTREG (0x0A00 0664)	283
12.2.13 DMAITMKREG (0x0A00 0666)	284
CHAPTER 13 CLOCKED SERIAL INTERFACE UNIT (CSI)	285
13.1 Overview	285
13.2 Operation of CSI	285
13.2.1 Transmit / receive operations	285
13.2.2 SCK phase and CSI transfer timing	286
13.2.3 CSI Transfer Types	287
13.2.4 Transmit and receive FIFOs	288
13.3 CSI Registers	288
13.3.1 CSIMODE (0x0B00 0900)	289
13.3.2 CSIRXDATA (0x0B00 0902)	291
13.3.3 CSITXDATA (0x0B00 0904)	291
13.3.4 CSILSTAT (0x0B00 0906)	292
13.3.5 CSIINTMSK (0x0B00 0908)	294
13.3.6 CSIINTSTAT (0x0B00 090A)	295
13.3.7 CSITXBLEN (0x0B00 090C)	297
13.3.8 CSIRXBLEN (0x0B00 090E)	298

CHAPTER 14 INTERRUPT CONTROL UNIT (ICU)	299
14.1 Overview	299
14.2 Register Set	301
14.2.1 SYSINT1REG (0x0A00 0080)	302
14.2.2 MSYSINT1REG (0x0A00 008C)	304
14.2.3 NMIREG (0x0A00 0098)	306
14.2.4 SOFTINTREG (0x0A00 009A)	307
14.2.5 SYSINT2REG (0x0A00 0200)	308
14.2.6 MSYSINTREG2 (0x0A00 0206)	309
14.2.7 PIUINTREG (0x0B00 0082)	310
14.2.8 AIUINTREG (0x0B00 0084)	311
14.2.9 MPIUINTREG (0x0B00 008E)	312
14.2.10 MAIUINTREG (0x0B00 0090)	313
14.2.11 MKIUINTREG (0x0B00 0092)	314
14.2.12 KIUINTREG (0x0B00 0198)	315
CHAPTER 15 POWER MANAGEMENT UNIT (PMU)	317
15.1 General	317
15.2 Reset Control	317
15.2.1 RTC reset	318
15.2.2 RSTSW reset	318
15.2.3 Preserving DRAM data on RSTSW reset	318
15.3 Shutdown Control	319
15.3.1 HALTimer shutdown	319
15.3.2 Deadman's SW shutdown	319
15.3.3 Software shutdown	319
15.3.4 BATTINH shutdown	319
15.4 Power-on Control	320
15.4.1 Activation via Power Switch interrupt request	321
15.4.2 Activation via CompactFlash interrupt request	322
15.4.3 Activation via GPIO Activation interrupt request	323
15.4.4 Activation via DCD Interrupt	324
15.4.5 Activation via Elapsed Timer interrupt (alarm interrupt)	326
15.5 DRAM Interface Control	327
15.5.1 System request to enter Hibernate mode (EDO DRAM)	327
15.5.2 System request to enter Hibernate mode (SDRAM)	328
15.5.3 Wake-up from Hibernate mode (EDO DRAM)	328
15.5.4 Wake-up from Hibernate mode (SDRAM)	329
15.5.5 Suspend mode	329
15.6 Register Set	330
15.6.1 PMUINTREG (0x0B00 00A0)	331
15.6.2 PMUCNTREG (0x0B00 00A2)	333
15.6.3 PMUWAITREG (0x0B00 00A8)	335
15.6.4 PMUDIVREG (0x0B00 00AC)	336
15.6.5 DRAMHIBCTL (0x0B00 00B2)	337

15.7 Vr4181 Power Mode	338
15.7.1 Power mode and state transition	338
CHAPTER 16 REALTIME CLOCK UNIT (RTC)	341
16.1 General	341
16.2 Register Set	342
16.2.1 Elapsed Time registers	343
16.2.2 Elapsed Time compare registers	345
16.2.3 RTC Long 1 registers	347
16.2.4 RTC Long 1 Count registers	349
16.2.5 RTC Long 2 registers	351
16.2.6 RTC Long 2 Count registers	353
16.2.7 RTC interrupt register	355
CHAPTER 17 DEADMAN'S SWITCH UNIT (DSU)	357
17.1 General	357
17.2 Register Set	357
17.2.1 DSUCNTREG (0x0B00 00E0)	358
17.2.2 DSUSETREG (0x0B00 00E2)	359
17.2.3 DSUCLRREG (0x0B00 00E4)	360
17.2.4 DSUTIMREG (0x0B00 00E6)	361
17.3 Register Setting Flow	362
CHAPTER 18 GENERAL PURPOSE I/O UNIT (GIU)	363
18.1 Overview	363
18.1.1 GPIO pins and alternate functions	363
18.1.2 Pin direction control	365
18.1.3 Non-volatile registers	365
18.2 Alternate Functions Overview	366
18.2.1 Clocked serial interface (CSI)	366
18.2.2 Primary and secondary serial (RS-232-C) interface	366
18.2.3 LCD interface	368
18.2.4 Programmable chip selects	369
18.2.5 16-bit cycle support	369
18.2.6 General purpose input/output	370
18.2.7 Interrupt requests and wake-up events	370
18.3 Register Set	371
18.3.1 GPMD0REG (0x0B00 0300)	373
18.3.2 GPMD1REG (0x0B00 0302)	375
18.3.3 GPMD2REG (0x0B00 0304)	377
18.3.4 GPMD3REG (0x0B00 0306)	379
18.3.5 GPDATHREG (0x0B00 0308)	381
18.3.6 GPDATLREG (0x0B00 030A)	382

18.3.7	GPINTEN (0x0B00 030C)	383
18.3.8	GPINTMSK (0x0B00 030E)	384
18.3.9	GPINTTYPH (0x0B00 0310)	385
18.3.10	GPINTTYPL (0x0B00 0312)	387
18.3.11	GPINTSTAT (0x0B00 0314)	389
18.3.12	GPHIBSTH (0x0B00 0316)	390
18.3.13	GPHIBSTL (0x0B00 0318)	391
18.3.14	GPSICTL (0x0B00 031A)	392
18.3.15	KEYEN (0x0B00 031C)	394
18.3.16	PCS0STRA (0x0B00 0320)	395
18.3.17	PCS0STPA (0x0B00 0322)	395
18.3.18	PCS0HIA (0x0B00 0324)	396
18.3.19	PCS1STRA (0x0B00 0326)	397
18.3.20	PCS1STPA (0x0B00 0328)	397
18.3.21	PCS1HIA (0x0B00 032A)	398
18.3.22	PCSMODE (0x0B00 032C)	399
18.3.23	LCDGPMODE (0x0B00 032E)	400
18.3.24	MISCREGn (0x0B00 0330 to 0x0B00 034E)	401
CHAPTER 19 TOUCH PANEL INTERFACE UNIT (PIU)		403
19.1	General	403
19.1.1	Block diagrams	404
19.2	Scan Sequencer State Transition	406
19.3	Register Set	408
19.3.1	PIUCNTREG (0x0B00 0122)	409
19.3.2	PIUINTREG (0x0B00 0124)	412
19.3.3	PIUSIVLREG (0x0B00 0126)	413
19.3.4	PIUSTBLREG (0x0B00 0128)	414
19.3.5	PIUCMDREG (0x0B00 012A)	415
19.3.6	PIUASCNREG (0x0B00 0130)	417
19.3.7	PIUAMSKREG (0x0B00 0132)	419
19.3.8	PIUCIVLREG (0x0B00 013E)	420
19.3.9	PIUPBnmREG (0x0B00 02A0 to 0x0B00 02AE, 0x0B00 02BC to 0x0B00 02BE)	421
19.3.10	PIUABnREG (0x0B00 02B0 to 0x0B00 02B6)	422
19.4	Register Setting Flow	423
19.5	Relationships among TPX, TPY, ADIN, and AUDIOIN Pins and States	425
19.6	Timing	426
19.6.1	Touch/release detection timing	426
19.6.2	A/D port scan timing	426
19.7	Data Loss Interrupt Conditions	427
CHAPTER 20 AUDIO INTERFACE UNIT (AIU)		429
20.1	General	429
20.2	Register Set	429
20.2.1	MDMADATREG (0x0B00 0160)	430
20.2.2	SDMADATREG (0x0B00 0162)	431

20.2.3 DAVREF_SETUP (0x0B00 0164)	432
20.2.4 SODATREG (0x0B00 0166)	433
20.2.5 SCNTREG (0x0B00 0168)	434
20.2.6 SCNVC_END (0x0B00 016E)	435
20.2.7 MIDATREG (0x0B00 0170)	436
20.2.8 MCNTREG (0x0B00 0172)	437
20.2.9 DVALIDREG (0x0B00 0178)	438
20.2.10 SEQREG (0x0B00 017A)	439
20.2.11 INTREG (0x0B00 017C)	440
20.2.12 MCNVC_END (0x0B00 017E)	441
20.3 Operation Sequence	442
20.3.1 Output (speaker)	442
20.3.2 Input (microphone)	443
CHAPTER 21 KEYBOARD INTERFACE UNIT (KIU)	445
21.1 General	445
21.2 Functional Description	445
21.2.1 Automatic keyboard scan mode	445
21.2.2 Manual keyboard scan mode	446
21.2.3 Key press detection	446
21.2.4 Scan operation	447
21.2.5 Reading return data	447
21.2.6 Interrupts and status reporting	448
21.3 Register Set	449
21.3.1 KIUDATn (0x0B00 0180 to 0x0B00 018E)	450
21.3.2 KIUSCANREP (0x0B00 0190)	451
21.3.3 KIUSCANS (0x0B00 0192)	452
21.3.4 KIUWKS (0x0B00 0194)	453
21.3.5 KIUWKI (0x0B00 0196)	454
21.3.6 KIUIINT (0x0B00 0198)	455
CHAPTER 22 COMPACTFLASH CONTROLLER (ECU)	457
22.1 General	457
22.2 Register Set Summary	457
22.3 ECU Control Registers	460
22.3.1 INTSTATREG (0x0B00 08F8)	460
22.3.2 INTMSKREG (0x0B00 08FA)	461
22.3.3 CFG_REG_1 (0x0B00 08FE)	462
22.4 ECU Registers	463
22.4.1 ID_REV_REG (Index: 0x00)	463
22.4.2 IF_STAT_REG (Index: 0x01)	464
22.4.3 PWRRSETDRV (Index: 0x02)	465
22.4.4 ITGENCTREG (Index: 0x03)	466
22.4.5 CDSTCHGREG (Index: 0x04)	467
22.4.6 CRDSTATREG (Index: 0x05)	468
22.4.7 ADWINENREG (Index: 0x06)	469

22.4.8	IOCTRL_REG (Index: 0x07)	470
22.4.9	IOADSLBnREG (Index: 0x08, 0x0C)	471
22.4.10	IOADSHBnREG (Index: 0x09, 0x0D)	471
22.4.11	IOSLBnREG (Index: 0x0A, 0x0E)	472
22.4.12	IOSHBnREG (Index: 0x0B, 0x0F)	472
22.4.13	SYSTEMSLnREG (Index: 0x10, 0x18, 0x20, 0x28, 0x30)	473
22.4.14	MEMWIDn_REG (Index: 0x11, 0x19, 0x21, 0x29, 0x31)	473
22.4.15	SYSTEMELnREG (Index: 0x12, 0x1A, 0x22, 0x2A, 0x32)	474
22.4.16	MEMSELn_REG (Index: 0x13, 0x1B, 0x23, 0x2B, 0x33)	474
22.4.17	MEMOFFLnREG (Index: 0x14, 0x1C, 0x24, 0x2C, 0x34)	475
22.4.18	MEMOFFHnREG (Index: 0x15, 0x1D, 0x25, 0x2D, 0x35)	475
22.4.19	DTGENCLREG (Index: 0x16)	476
22.4.20	GLOCTRLREG (Index: 0x1E)	477
22.4.21	VOLTSENREG (Index: 0x1F)	477
22.4.22	VOLTSELREG (Index: 0x2F)	477
CHAPTER 23 LED CONTROL UNIT (LED)		479
23.1	General	479
23.2	Register Set	479
23.2.1	LEDHTSREG (0x0B00 0240)	480
23.2.2	LEDLTSREG (0x0B00 0242)	481
23.2.3	LEDCNTREG (0x0B00 0248)	482
23.2.4	LEDASTCREG (0x0B00 024A)	483
23.2.5	LEDINTREG (0x0B00 024C)	484
23.3	Operation Flow	485
CHAPTER 24 SERIAL INTERFACE UNIT 1 (SIU1)		487
24.1	General	487
24.2	Clock Control Logic	487
24.3	Register Set	488
24.3.1	SIURB_1 (0x0C00 0010: LCR7 = 0, Read)	489
24.3.2	SIUTH_1 (0x0C00 0010: LCR7 = 0, Write)	489
24.3.3	SIUDLL_1 (0x0C00 0010: LCR7 = 1)	489
24.3.4	SIUIE_1 (0x0C00 0011: LCR7 = 0)	490
24.3.5	SIUDLM_1 (0x0C00 0011: LCR7 = 1)	491
24.3.6	SIUIID_1 (0x0C00 0012: Read)	493
24.3.7	SIUFC_1 (0x0C00 0012: Write)	495
24.3.8	SIULC_1 (0x0C00 0013)	498
24.3.9	SIUMC_1 (0x0C00 0014)	499
24.3.10	SIULS_1 (0x0C00 0015)	500
24.3.11	SIUMS_1 (0x0C00 0016)	502
24.3.12	SIUSC_1 (0x0C00 0017)	503
24.3.13	SIURESET_1 (0x0C00 0019)	503
24.3.14	SIUACTMSK_1 (0x0C00 001C)	504
24.3.15	SIUACTTMR_1 (0x0C00 001E)	505

CHAPTER 25 SERIAL INTERFACE UNIT 2 (SIU2)	507
25.1 General	507
25.2 Clock Control Logic	507
25.3 Register Set	508
25.3.1 SIURB_2 (0x0C00 0000: LCR7 = 0, Read)	509
25.3.2 SIUTH_2 (0x0C00 0000: LCR7 = 0, Write)	509
25.3.3 SIUDLL_2 (0x0C00 0000: LCR7 = 1)	509
25.3.4 SIUIE_2 (0x0C00 0001: LCR7 = 0)	510
25.3.5 SIUDLM_2 (0x0C00 0001: LCR7 = 1)	511
25.3.6 SIUIID_2 (0x0C00 0002: Read)	513
25.3.7 SIUFC_2 (0x0C00 0002: Write)	515
25.3.8 SIULC_2 (0x0C00 0003)	518
25.3.9 SIUMC_2 (0x0C00 0004)	519
25.3.10 SIULS_2 (0x0C00 0005)	520
25.3.11 SIUMS_2 (0x0C00 0006)	522
25.3.12 SIUSC_2 (0x0C00 0007)	523
25.3.13 SIUIRSEL_2 (0x0C00 0008)	523
25.3.14 SIURESET_2 (0x0C00 0009)	524
25.3.15 SIUCSEL_2 (0x0C00 000A)	524
25.3.16 SIUACTMSK_2 (0x0C00 000C)	525
25.3.17 SIUACTTMR_2 (0x0C00 000E)	526
CHAPTER 26 LCD CONTROLLER	527
26.1 Overview	527
26.1.1 LCD interface	527
26.2 Summary of LCD Module Features	528
26.3 LCD Controller Specification	530
26.3.1 Panel configuration and interface	530
26.3.2 Controller clocks	533
26.3.3 Palette	534
26.3.4 Frame buffer memory and FIFO	534
26.3.5 Panel power ON/OFF sequence	535
26.3.6 Controller operation diagrams	536
26.4 Register Set	541
26.4.1 HRTOTALREG (0x0A00 0400)	542
26.4.2 HRVISIBREG (0x0A00 0402)	542
26.4.3 LDCLKSTREG (0x0A00 0404)	543
26.4.4 LDCLKNDREG (0x0A00 0406)	543
26.4.5 VRTOTALREG (0x0A00 0408)	544
26.4.6 VRVISIBREG (0x0A00 040A)	544
26.4.7 FVSTARTREG (0x0A00 040C)	545
26.4.8 FVENDREG (0x0A00 040E)	545
26.4.9 LCDCTRLREG (0x0A00 0410)	546
26.4.10 LCDINRQREG (0x0A00 0412)	547
26.4.11 LCDCFGREG0 (0x0A00 0414)	548
26.4.12 LCDCFGREG1 (0x0A00 0416)	549

26.4.13	FBSTAD1REG (0x0A00 0418)	550
26.4.14	FBSTAD2REG (0x0A00 041A)	550
26.4.15	FBENDADREG1 (0x0A00 0420)	551
26.4.16	FBENDADREG2 (0x0A00 0422)	551
26.4.17	FHSTARTREG (0x0A00 0424)	552
26.4.18	FHNSDREG (0x0A00 0426)	552
26.4.19	PWRCONREG1 (0x0A00 0430)	553
26.4.20	PWRCONREG2 (0x0A00 0432)	554
26.4.21	LCDIMSKREG (0x0A00 0434)	555
26.4.22	CPINDCTREG (0x0A00 047E)	556
26.4.23	CPALDATREG (0x0A00 0480)	557
CHAPTER 27 MIPS III INSTRUCTION SET DETAILS		559
27.1	Instruction Notation Conventions	559
27.2	Load and Store Instructions	561
27.3	Jump and Branch Instructions	562
27.4	System Control Coprocessor (CP0) Instructions	563
27.5	CPU Instruction	563
27.6	CPU Instruction Opcode Bit Encoding	709
CHAPTER 28 MIPS16 INSTRUCTION SET FORMAT		711
CHAPTER 29 VR4181 COPROCESSOR 0 HAZARDS		751
CHAPTER 30 PLL PASSIVE COMPONENTS		757

LIST OF FIGURES (1/4)

Fig. No.	Title	Page
1-1.	Internal Block Diagram	32
1-2.	VR4110 CPU Core Internal Block Diagram	37
1-3.	CPU Registers	39
1-4.	CP0 Registers	40
3-1.	MIPS III ISA CPU Instruction Formats	59
3-2.	Byte Specification Related to Load and Store Instructions	61
5-1.	Pipeline Stages	107
5-2.	Instruction Execution in the Pipeline	108
5-3.	Pipeline Activities	108
5-4.	Branch Delay	110
5-5.	Add Instruction Pipeline Activities	111
5-6.	JALR Instruction Pipeline Activities	112
5-7.	BEQ Instruction Pipeline Activities	113
5-8.	TLT Instruction Pipeline Activities	114
5-9.	LW Instruction Pipeline Activities	115
5-10.	SW Instruction Pipeline Activities	116
5-11.	Interlocks, Exceptions, and Faults	117
5-12.	Exception Detection	120
5-13.	Data Cache Miss Stall	121
5-14.	CACHE Instruction Stall	121
5-15.	Load Data Interlock	122
5-16.	MD Busy Interlock	123
6-1.	Virtual-to-Physical Address Translation	126
6-2.	32-bit Mode Virtual Address Translation	127
6-3.	64-bit Mode Virtual Address Translation	128
6-4.	User Mode Address Space	130
6-5.	Supervisor Mode Address Space	132
6-6.	Kernel Mode Address Space	135
6-7.	xkphys Area Address Space	136
6-8.	VR4181 Physical Address Space	142
6-9.	CP0 Registers and the TLB	146
6-10.	Format of a TLB Entry	147
6-11.	Index Register	148
6-12.	Random Register	148
6-13.	EntryLo0 and EntryLo1 Registers	149
6-14.	Page Mask Register	150
6-15.	Positions Indicated by the Wired Register	151
6-16.	Wired Register	151
6-17.	EntryHi Register	152
6-18.	PRId Register	153
6-19.	Config Register Format	154

LIST OF FIGURES (2/4)

Fig. No.	Title	Page
6-20.	LLAddr Register	155
6-21.	TagLo Register	156
6-22.	TagHi Register	156
6-23.	TLB Address Translation	158
7-1.	Context Register Format	164
7-2.	BadVAddr Register Format	165
7-3.	Count Register Format	165
7-4.	Compare Register Format	166
7-5.	Status Register Format	166
7-6.	Status Register Diagnostic Status Field	167
7-7.	Cause Register Format	169
7-8.	EPC Register Format (When MIPS16 ISA Is Disabled)	171
7-9.	EPC Register Format (When MIPS16 ISA Is Enabled)	172
7-10.	WatchLo Register Format	172
7-11.	WatchHi Register Format	173
7-12.	XContext Register Format	173
7-13.	Parity Error Register Format	174
7-14.	Cache Error Register Format	174
7-15.	ErrorEPC Register Format (When MIPS16 ISA Is Disabled)	176
7-16.	ErrorEPC Register Format (When MIPS16 ISA Is Enabled)	176
7-17.	Common Exception Handling	196
7-18.	TLB/XTLB Refill Exception Handling	198
7-19.	Cold Reset Exception Handling	200
7-20.	Soft Reset and NMI Exception Handling	201
8-1.	RTC Reset	204
8-2.	RSTSW	205
8-3.	Deadman's Switch	206
8-4.	Software Shutdown	207
8-5.	HALTimer shutdown	208
8-6.	VR4181 Activation Sequence (when activation is OK)	209
8-7.	VR4181 Activation Sequence (when activation is NG)	210
8-8.	Cold Reset	211
8-9.	Soft Reset	212
9-1.	Logical Hierarchy of Memory	217
9-2.	Cache Support	218
9-3.	Instruction Cache Line Format	219
9-4.	Data Cache Line Format	219
9-5.	Cache Data and Tag Organization	220
9-6.	Data Cache State Diagram	223
9-7.	Instruction Cache State Diagram	223
9-8.	Data Check Flow on Instruction Fetch	224

LIST OF FIGURES (3/4)

Fig. No.	Title	Page
9-9.	Data Check Flow on Load Operations	224
9-10.	Data Check Flow on Store Operations	225
9-11.	Data Check Flow on Index_Invalidate Operations	225
9-12.	Data Check Flow on Index_Writeback_Invalidate Operations	226
9-13.	Data Check Flow on Index_Load_Tag Operations	226
9-14.	Data Check Flow on Index_Store_Tag Operations	227
9-15.	Data Check Flow on Create_Dirty Operations	227
9-16.	Data Check Flow on Hit_Invalidate Operations	228
9-17.	Data Check Flow on Hit_Writeback_Invalidate Operations	228
9-18.	Data Check Flow on Fill Operations	229
9-19.	Data Check Flow on Hit_Writeback Operations	229
9-20.	Writeback Flow	230
9-21.	Refill Flow	230
9-22.	Writeback & Refill Flow	231
10-1.	Non-maskable Interrupt Signal	233
10-2.	Hardware Interrupt Signals	235
10-3.	Masking of the Interrupt Request Signals	236
11-1.	V _R 4181 Internal Bus Structure	237
11-2.	ROM Read Cycle	243
11-3.	Ordinary ROM Read Cycle (WROMA(3:0) = 0100)	254
11-4.	PageROM Read Cycle (WROMA(3:0) = 0011, WPROM(2:0) = 001)	255
11-5.	Flash Memory Read Cycle (WROMA(3:0) = 0111)	256
11-6.	Flash Memory Write Cycle (WROMA(3:0) = 0111)	256
11-7.	External EDO DRAM Configuration	257
11-8.	SDRAM Configuration	259
13-1.	SCK and SI/SO Relationship	286
14-1.	Peripheral Logic Block Assignment for Interrupt Registers	300
15-1.	EDO DRAM Signals on RSTSW Reset (SDRAM bit = 0)	318
15-2.	Activation via Power Switch Interrupt Request (BATTINH = H)	321
15-3.	Activation via Power Switch Interrupt Request (BATTINH = L)	321
15-4.	Activation via CompactFlash Interrupt Request (BATTINH = H)	322
15-5.	Activation via CompactFlash Interrupt Request (BATTINH = L)	322
15-6.	Activation via GPIO Activation Interrupt (BATTINH = H)	323
15-7.	Activation via GPIO Activation Interrupt (BATTINH = L)	323
15-8.	Activation via DCD Interrupt (BATTINH = H)	325
15-9.	Activation via DCD Interrupt (BATTINH = L)	325
15-10.	Activation via Alarm Interrupt (BATTINH = H)	326
15-11.	Activation via Alarm Interrupt (BATTINH = L)	326
15-12.	Transition of V _R 4181 Operating Mode (Power Mode)	339

LIST OF FIGURES (4/4)

Fig. No.	Title	Page
18-1.	GPIO(15:0) Interrupt Request Detecting Logic	370
19-1.	PIU Peripheral Block Diagram	404
19-2.	Coordinate Detection Equivalent Circuits	405
19-3.	Internal Block Diagram of PIU	405
19-4.	Scan Sequencer State Transition Diagram	406
19-5.	Interval Times and States	414
19-6.	Touch/Release Detection Timing	426
19-7.	A/D Port Scan Timing	426
20-1.	Speaker Output and AUDIOOUT Pin	442
20-2.	AUDIOIN Pin and Microphone Operation	443
22-1.	CompactFlash Interrupt Logic	462
24-1.	SIU1 Block Diagram	487
25-1.	SIU2 Block Diagram	507
26-1.	LCD Controller Block Diagram	529
26-2.	View Rectangle and Horizontal/Vertical Blank	530
26-3.	Position of Load Clock, LOCLK	531
26-4.	Position of Frame Edge, FLM	532
26-5.	Monochrome Panel	536
26-6.	Color Panel in 8-bit Data Bus	537
26-7.	Load Clock (LOCLK)	538
26-8.	Frame Clock (FLM)	538
26-9.	LCD Timing Parameters	539
26-10.	FLM Period	539
27-1.	VR4181 Opcode Bit Encoding	709
30-1.	Example of Connection of PLL Passive Components	757

LIST OF TABLES (1/4)

Table No.	Title	Page
1-1.	Supported PClock and TClock Frequencies	33
1-2.	Devices Supported by System Bus	33
1-3.	GPIO(31:0) Pin Functions	35
1-4.	LCD Panel Resolutions (in Pixels, TYP.)	36
1-5.	Functions of LCD Interface Pins when LCD Controller Is Disabled	36
1-6.	System Control Coprocessor (CP0) Register Definitions	41
3-1.	Number of Delay Slot Cycles Necessary for Load and Store Instructions	60
3-2.	Load/Store Instruction	62
3-3.	Load/Store Instruction (Extended ISA)	63
3-4.	ALU Immediate Instruction	64
3-5.	ALU Immediate Instruction (Extended ISA)	65
3-6.	Three-Operand Type Instruction	65
3-7.	Three-Operand Type Instruction (Extended ISA)	66
3-8.	Shift Instruction	66
3-9.	Shift Instruction (Extended ISA)	67
3-10.	Multiply/Divide Instructions	68
3-11.	Multiply/Divide Instructions (Extended ISA)	68
3-12.	Number of Stall Cycles in Multiply and Divide Instructions	69
3-13.	Number of Delay Slot Cycles in Jump and Branch Instructions	70
3-14.	Jump Instruction	71
3-15.	Branch Instructions	72
3-16.	Branch Instructions (Extended ISA)	73
3-17.	Special Instructions	74
3-18.	Special Instructions (Extended ISA)	74
3-19.	System Control Coprocessor (CP0) Instructions	75
4-1.	General-Purpose Registers	78
4-2.	Special Registers	79
4-3.	MIPS16 Instruction Set Outline	81
4-4.	Field Definition	82
4-5.	Bit Encoding of Major Operation Code (op)	87
4-6.	RR Minor Operation Code (RR-Type Instruction)	87
4-7.	RRR Minor Operation Code (RRR-Type Instruction)	88
4-8.	RRRI-A Minor Operation Code (RRI-Type ADD Instruction)	88
4-9.	SHIFT Minor Operation Code (SHIFT-Type Instruction)	88
4-10.	I8 Minor Operation Code (I8-Type Instruction)	88
4-11.	I64 Minor Operation Code (64-bit Only, I64-Type Instruction)	89
4-12.	Base PC Address Setting	90
4-13.	Extendable MIPS16 Instructions	92
4-14.	Load and Store Instructions	94
4-15.	ALU Immediate Instructions	97
4-16.	Two-/Three-Operand Register Type	99
4-17.	Shift Instructions	101
4-18.	Multiply/Divide Instructions	103

LIST OF TABLES (2/4)

Table No.	Title	Page
4-19.	Jump and Branch Instructions	105
4-20.	Special Instructions	106
5-1.	Description of Pipeline Activities during Each Stage	109
5-2.	Correspondence of Pipeline Stage to Interlock and Exception Conditions	118
5-3.	Pipeline Interlock	119
5-4.	Description of Pipeline Exception	119
6-1.	Comparison of useg and xuseg	130
6-2.	32-bit and 64-bit Supervisor Mode Segments	133
6-3.	32-bit Kernel Mode Segments	137
6-4.	64-bit Kernel Mode Segments	139
6-5.	Cacheability and the xkphys Address Space	140
6-6.	VR4181 Physical Address Space	143
6-7.	ROM Address Map	143
6-8.	Internal I/O Space 1	144
6-9.	Internal I/O Space 2	144
6-10.	MBA Bus I/O Space	145
6-11.	DRAM Address Map	145
6-12.	Cache Algorithm	150
6-13.	Mask Values and Page Sizes	150
7-1.	CP0 Exception Processing Registers	163
7-2.	Cause Register Exception Code Field	170
7-3.	64-Bit Mode Exception Vector Base Addresses	178
7-4.	32-Bit Mode Exception Vector Base Addresses	178
7-5.	Exception Priority Order	179
11-1.	Bus Control Registers	239
11-2.	VR4181 EDO DRAM Capacity	258
11-3.	Memory Controller Registers	260
11-4.	ISA Bridge Registers	266
12-1.	DCU Registers	273
13-1.	CSI Registers	288
14-1.	ICU Registers	301
15-1.	Operations during Reset	317
15-2.	Operations during Shutdown	319
15-3.	PMU Registers	330
15-4.	Overview of Power Mode	340

LIST OF TABLES (3/4)

Table No.	Title	Page
16-1.	RTC Registers	342
17-1.	DSU Registers	357
18-1.	Signal Assignment of GPIO(15:0) Pins	363
18-2.	Signal Assignment of GPIO(31:16) Pins	364
18-3.	CSI Interface Signals	366
18-4.	Primary Serial Interface Signals	366
18-5.	Primary Serial Interface Loopback Control	367
18-6.	Secondary Serial Interface Signals Using GPIO Pins	367
18-7.	Secondary Serial Interface Loopback Control	368
18-8.	STN Color LCD Interface Signals	368
18-9.	External LCDC Interface Signals	368
18-10.	Programmable Chip Select Signals	369
18-11.	GIU Registers	371
19-1.	PIU Registers	408
19-2.	PIU Interrupt Registers	408
19-3.	PIUCNTREG Bit Manipulation and States	411
19-4.	PIUASCNREG Bit Manipulation and States	418
19-5.	Detected Coordinates and Page Buffers	421
19-6.	A/D Ports and Data Buffers	422
19-7.	Mask Clear During Scan Sequence Operation	423
20-1.	AIU Registers	429
20-2.	AIU Interrupt Registers	429
21-1.	KIU Registers	449
21-2.	KIU Interrupt Registers	449
22-1.	ECU Control Registers	457
22-2.	ECU Registers	458
23-1.	LED Registers	479
24-1.	SIU1 Registers	488
24-2.	Correspondence between Baud Rates and Divisors	492
24-3.	Interrupt Function	494
25-1.	SIU2 Registers	508
25-2.	Correspondence between Baud Rates and Divisors	512
25-3.	Interrupt Function	514

LIST OF TABLES (4/4)

Table No.	Title	Page
26-1.	LCD Panel Resolutions (in Pixels, TYP.)	527
26-2.	Redefining LCD Interface Pins When LCD Controller Is Disabled	528
26-3.	LCD Controller Parameters	540
26-4.	LCD Controller Registers	541
27-1.	CPU Instruction Operation Notations	560
27-2.	Load and Store Common Functions	561
27-3.	Access Type Specifications for Loads/Stores	562
29-1.	VR4181 Coprocessor 0 Hazards	752
29-2.	Calculation Example of CP0 Hazard and Number of Instructions Inserted	755

[MEMO]

CHAPTER 1 INTRODUCTION

This chapter describes the outline of the VR4181 (μ PD30181), which is a 64-bit microprocessor.

1.1 Features

The VR4181, which is a high-performance 64-bit microprocessor employing the RISC (reduced instruction set computer) architecture developed by MIPS™, is one of the VR-Series microprocessor products manufactured by NEC.

The VR4181 contains the VR4110™ CPU core of ultra-low-power consumption with cache memory, high-speed product-sum operation unit, and memory management unit. It also has interface units for peripheral circuits such as LCD controller, CompactFlash controller, DMA controller, keyboard interface, serial interface, IrDA interface, touch panel interface, real-time clock, A/D converter and D/A converter required for the battery-driven portable information equipment. The features of the VR4181 are described below.

- Employs 0.25 μ m process
- 64-bit RISC VR4110 CPU core with pipeline clock up to 66 MHz (operation in 32-bit mode is available)
- Optimized 5-stage pipeline
- On-chip instruction and data caches with 4 KB each in size
- Write-back cache for reducing store operation that use the system bus
- 32-bit physical address space and 40-bit virtual address space, and 32 double-entry TLB
- Instruction set: MIPS III (with the FPU, LL and SC instructions left out) and MIPS16
- Supports MADD16 and DMADD16 instructions for executing a multiply-and-accumulate operation of 16-bit data x 16-bit data + 64-bit data within one clock cycle
- Effective power management features, which include four operating modes, Fullspeed, Standby, Suspend and Hibernate mode
- On-chip PLL and clock generator
- DRAM interface supporting 16-bit width SDRAM and EDO DRAM
- Ordinary ROM/PageROM/flash memory interface
- UMA based LCD controller
- 4-channel DMA controller
- RTC unit including 3-channel timers and counters
- Two UART-compatible serial interfaces and one clocked serial interface
- IrDA(SIR) interface
- Keyboard scan interface supporting 8 x 8 key matrix
- X-Y auto-scan touch panel interface
- CompactFlash interface compatible with ExCA
- A/D and D/A converters
- Includes ISA-subset bus
- Supply voltage: 2.5 V for CPU core, 3.3 V for I/O
- Package: 160-pin LQFP

1.2 Ordering Information

Part number	Package
μ PD30181GM-66-8ED	160-pin plastic LQFP (fine pitch) (24 × 24)

1.3 Vr4181 Key Features

Figure 1-1. Internal Block Diagram

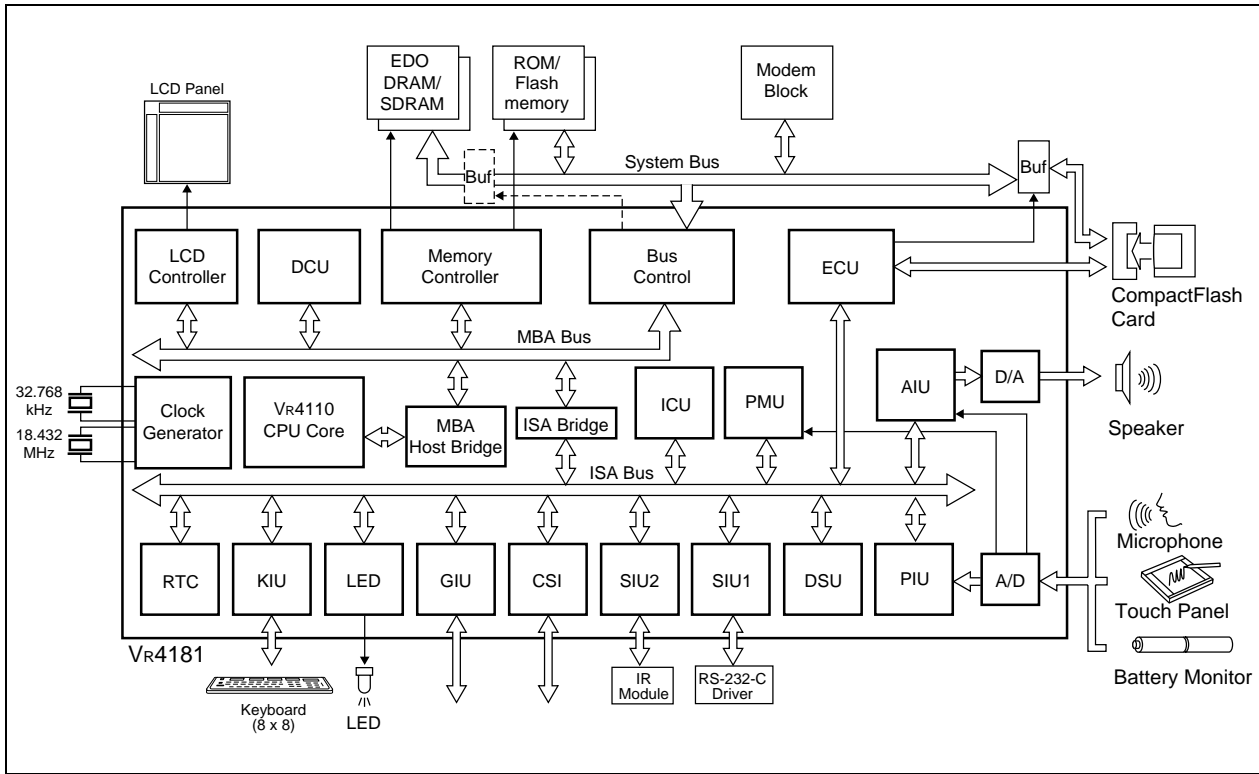

1.3.1 CPU core

The VR4181 integrates an NEC VR4110 CPU core supporting both the MIPS III and MIPS16 instruction sets.

The VR4181 supports the following pipeline clock (PClock) and internal bus clock (TClock) frequencies. The PClock is set by attaching pull-up or pull-down resistors to the CLKSEL(2:0) pins. The frequency of the TClock, which is used in MBA bus, is set by PMUDIVREG register in Power Management Unit.

Table 1-1. Supported PClock and TClock Frequencies

PClock frequency	TClock frequency
65.4 MHz	65.4 / 32.7 / 21.8 / 16.4 MHz
62.0 MHz	62.0 / 31.0 / 20.7 / 15.5 MHz
49.1 MHz	49.1 / 24.6 / 16.4 / 12.3 MHz

The VR4110 core of the VR4181 includes 4 KB of instruction cache and 4 KB of data cache.

The VR4110 core also supports the following power management modes:

- Fullspeed
- Standby
- Suspend ^{Note}
- Hibernate

Note Suspend mode is supported only when the internal LCD controller has been disabled or the LCD panel has been powered off.

1.3.2 Bus interface

The VR4181 incorporates single bus architecture. All external memory and I/O devices are connected to the same 22-bit address bus and 16-bit data bus. These external address and data bus are together called the system bus.

When the external bus operates at a very high speed, the DRAM data bus must be isolated from other low speed devices such as ROM array. The VR4181 provides two pins, SYSEN# and SYSDIR, to control the data buffers for this isolation.

The VR4181 supports the following types of devices connected to the system bus.

Table 1-2. Devices Supported by System Bus

Device	Data width
ROM, flash memory	16 bits only
DRAM	16 bits only
CompactFlash	8 or 16 bits
External I/O	8 or 16 bits
External memory	8 or 16 bits

Six of the external bus interface signals, IORD#, IOWR#, IORDY, IOCS16#, MEMCS16# and RESET#, can be individually defined as general-purpose I/O pins or LCD interface pin if they are not needed by external system components.

1.3.3 Memory interface

The V_R4181 provides control for both ROM/flash memory and DRAM. Up to four 16-bit ROM/flash memory banks may be supported utilizing either 32-Mbit or 64-Mbit single cycle or page mode devices. Bank mixing is not supported for ROM/flash memory. When a system implements less than the maximum 4 banks of ROM/flash memory, unused ROM chip select pins can be defined as general-purpose I/O pins.

The V_R4181 also supports up to 2 banks of 1M x 16 or 4M x 16 EDO-type DRAM at bus frequencies of up to 66 MHz. When both banks are EDO-type DRAM, bank mixing is supported.

1.3.4 DMA controller (DCU)

The V_R4181 provides a 4-channel DMA controller to support internal DMA transfers. The 4 channels are allocated as follows:

- Channel 1 - Audio input
- Channel 2 - Audio output
- Channel 3, 4 - Reserved

1.3.5 Interrupt controller (ICU)

The V_R4181 provides an interrupt controller which combines all interrupt request sources into one of the V_R4110 core interrupt inputs - NMI and Int(3:0). The interrupt controller also provides interrupt request status reporting.

1.3.6 Real-time clock

The V_R4181 includes a real-time clock (RTC), which allows time keeping based on the 32.768 kHz clock as a source. The RTC operates as long as the V_R4181 remains powered.

1.3.7 Audio output (D/A converter)

The V_R4181 provides a 1-channel 10-bit D/A converter for generating audio output.

1.3.8 Touch panel interface and audio input (A/D converter)

The V_R4181 provides an 8-channel 10-bit A/D converter for interfacing to a touch panel, an external microphone, and other types of analog input.

1.3.9 CompactFlash interface (ECU)

The V_R4181 provides an ExCA-compatible bus controller supporting a single CompactFlash slot. This interface is shared with the keyboard interface logic and must be disabled when an 8 x 8 key matrix is connected to the V_R4181.

1.3.10 Primary serial interface (SIU1)

The V_R4181 provides a 16550 UART for implementing an RS-232-C type serial interface. When the serial interface is not needed, each of the 7 serial interface pins can be individually redefined as general-purpose I/O pins.

1.3.11 Secondary serial interface (SIU2)

The secondary serial interface is also based on a 16550 UART but only reserves 2 pins for the interface. The secondary serial interface can be configured in one of the following modes:

- Simple 2-wire serial interface using TxD2 and RxD2
- SIR-type IrDA interface using IRDIN and IRDOU
- Full RS-232-C compatible interface using TxD2, RxD2 and 5 GPIO pins

1.3.12 Clocked serial interface (CSI)

The VR4181 provides a clocked serial interface (CSI) which has an option to be configured as general-purpose I/O pins. This interface supports slave mode operation only. The clocked serial interface requires allocation of 4 signals; SI, SO, SCK, and FRM. The clock source for this interface is input on the pin assigned to SCK.

1.3.13 Keyboard interface (KIU)

The VR4181 provides support for an 8 x 8 key matrix. This keyboard interface can only be supported when the CompactFlash interface is disabled and reconfigured to provide the SCANIN(7:0) inputs and the SCANOUT(7:0) outputs.

1.3.14 General-purpose I/O

The VR4181 provides total 32 bits of general-purpose I/O. Sixteen of these, GPIO(31:16), are available through pins allocated to other functions as shown in the following table. The DCD1#/GPIO29 is the only one of the 16 pins that can cause the system's waking up from a low power mode if enabled by software. The other pins have no functions other than those listed below.

The remaining 16 bits of general-purpose I/O, GPIO(15:0), are allocated to pins by default. Each of these pins can be configured to support a particular interface such as CSI, secondary serial interface (RS-232-C), programmable chip selects, or color LCD control. Otherwise, each of these pins can be also defined as one of the following:

- General-purpose input
- General-purpose output
- Interrupt request input
- Wake-up input

Table 1-3. GPIO(31:0) Pin Functions

Pin designation	Alternate function	Pin designation	Alternate function
GPIO0	SI	GPIO16	IORD#
GPIO1	SO	GPIO17	IOWR#
GPIO2	SCK	GPIO18	IORDY
GPIO3	PCS0#	GPIO19	IOCS16#
GPIO4	–	GPIO20 ^{Note}	M/UBE#
GPIO5	DCD2#	GPIO21	RESET#
GPIO6	RTS2#	GPIO22	ROMCS0#
GPIO7	DTR2#	GPIO23	ROMCS1#
GPIO8	DSR2#	GPIO24	ROMCS2#
GPIO9	CTS2#	GPIO25	RxD1
GPIO10	FRM/SYSCLK	GPIO26	TxD1
GPIO11	PCS1#	GPIO27	RTS1#
GPIO12	FPD4	GPIO28	CTS1#
GPIO13	FPD5	GPIO29	DCD1#
GPIO14	FPD6/CD1#	GPIO30	DTR1#
GPIO15	FPD7/CD2#	GPIO31	DSR1#

Note This signal supports input only.

1.3.15 Programmable chip selects

The V_R4181 provides support for 2 programmable chip selects (PCS) which are also available as general-purpose I/O pins. Each PCS can decode either I/O or memory accesses and can optionally be qualified to read, write, or both read and write.

1.3.16 LCD interface

The LCD controller of the V_R4181 is Unified Memory Architecture (UMA) based in which the frame buffer is part of system DRAM. The LCD controller supports monochrome STN LCD panels having 1-bit, 2-bit, and 4-bit data bus interfaces and color STN LCD panels having 8-bit data bus interface. When interfacing to a color LCD panel, general-purpose I/O pins must be allocated to provide the upper nibble of the 8-bit LCD data bus.

In monochrome mode, the LCD controller supports 1-bpp mode (mono), 2-bpp mode (4 gray levels) and 4-bpp mode (16 gray levels). In color mode, it supports 4-bpp mode (16 colors) and 8-bpp mode (256 colors).

The LCD controller includes a 256-entry x 18-bit color pallet. In 4-bpp and 8-bpp color modes, the pallet is used to select one of 256 colors out of possible 262,144.

The LCD controller can be configured to support the following LCD panel horizontal/vertical resolutions typically.

Table 1-4. LCD Panel Resolutions (in Pixels, TYP.)

Horizontal resolution	Vertical resolution
320	320
320	240
320	160
240	320
240	240
240	160
160	320
160	240
160	160

The LCD controller also provides power-on and power-down sequence control for the LCD panel via the VPLCD and VPBIAS pins. Power sequencing is provided to prevent latch-up damage to the panel.

The LCD controller can be disabled to allow connection of an external LCDC with integrated frame buffer RAM such as NEC's μ PD1666x. When the internal LCD controller is disabled, the SHCLK, LOCLK, VPLCD, and VPBIAS pins are redefined as follows:

Table 1-5. Functions of LCD Interface Pins when LCD Controller Is Disabled

Redefined function	Default function
LCDCS#	SHCLK
MEMCS16#	LOCLK
VPGPIO1	VPLCD
VPGPIO0	VPBIAS

1.3.17 Wake-up events

The VR4181 supports 4 power management modes: Fullspeed, Standby, Suspend, and Hibernate. Of these modes, Hibernate is the lowest power mode and results in the powering off of all system components including the 2.5 V logic in the VR4181. The VR4181 3.3 V logic, which includes RTC, PMU, and non-volatile registers, remain powered during the Hibernate mode, as does the system DRAM. Software can configure the VR4181 waking up from the Hibernate mode and returning to Fullspeed mode due to any one of the following events:

- Activation of the DCD1# pin
- Activation of the POWER pin
- RTC alarm
- Activation of one of the GPIO(15:0) pins
- CompactFlash interrupt request

Remark Different from the VR4102™ or the VR4111™, the VR4181 will wake up after RTC reset.

1.4 VR4110 CPU Core

Figure 1-2 shows the internal block diagram of the VR4110 CPU core.

In addition to the conventional high-performance integer operation units, this CPU core has the full-associative format translation lookaside buffer (TLB), which has 32 entries that provide mapping to 2-page pairs (odd and even) for one entry. Moreover, it also includes instruction cache, data cache, and bus interface.

Figure 1-2. VR4110 CPU Core Internal Block Diagram

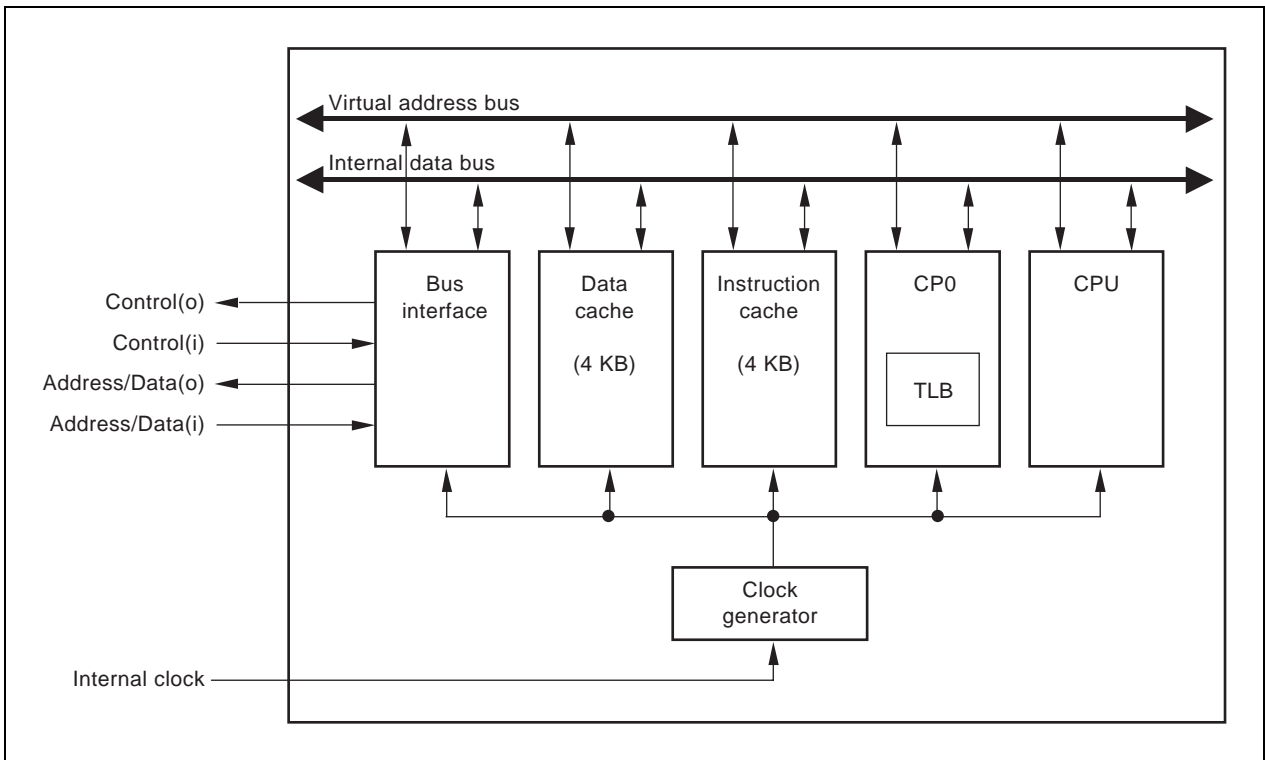

(1) CPU

The CPU has hardware resources to process an integer instruction. They are the 64-bit register file, 64-bit integer data path, and multiply-and-accumulate operation unit.

(2) Coprocessor 0 (CP0)

The CP0 incorporates a memory management unit (MMU) and exception handling function. MMU checks whether there is an access between different memory segments (user, supervisor, and kernel) by executing address conversion. The translation lookaside buffer (TLB) converts virtual addresses to physical addresses.

(3) Instruction cache

The instruction cache employs direct mapping, virtual index, and physical tag. Its capacity is 4 KB.

(4) Data cache

The data cache employs direct mapping, virtual index, physical tag, and write back. Its capacity is 4 KB.

(5) CPU bus interface

The CPU bus interface controls data transmission/reception between the Vr4110 core and the MBA Host Bridge. This interface consists of two 32-bit multiplexed address/data buses (one is for input, and another is for output), clock signal, and control signals such as interrupt requests.

(6) Clock generator

The following clock inputs are oscillated and supplied to internal units.

- 32.768 kHz clock for RTC unit
Crystal resonator input oscillated via an internal oscillator and supplied to the RTC unit.
- 18.432 MHz clock for serial interface and the Vr4181's reference operating clock
Crystal resonator input oscillated via an internal oscillator, and then multiplied by phase-locked loop (PLL) to generate a pipeline clock (PClock). The internal bus clock (TClock) is generated from PClock and supplied to peripheral units.

1.4.1 CPU registers

The Vr4110 core has thirty-two 64-bit general-purpose registers (GPRs). In addition, the processor provides the following special registers:

- 64-bit Program Counter (PC)
- 64-bit HI register, containing the integer multiply and divide upper doubleword result
- 64-bit LO register, containing the integer multiply and divide lower doubleword result

Two of the general-purpose registers have assigned functions as follows:

- r0 is hardwired to a value of zero, and can be used as the target register for any instruction whose result is to be discarded. r0 can also be used as a source when a zero value is needed.
- r31 is the link register used by link instructions, such as JAL (Jump and Link) instruction. This register can be used for other instructions. However, be careful that use of the register by a link instruction will not coincide with use of the register for other operations.

The register group is provided within the CP0, to process exceptions and to manage addresses.

CPU registers can operate as either 32-bit or 64-bit registers, depending on the Vr4181 processor mode of operation.

The operation of the CPU registers differs depending on what instructions are executed: 32-bit instructions or MIPS16 instructions. For details, refer to **CHAPTER 4 MIPS16 INSTRUCTION SET**.

Figure 1-3 shows the CPU registers.

The Vr4181 has no Program Status Word (PSW) register as such; this is covered by the Status and Cause registers incorporated within the System Control Coprocessor (CP0).

The CP0 registers are used for exception handling or address management. The overview of these registers is described in **1.4.2 Coprocessors**.

Figure 1-3. CPU Registers

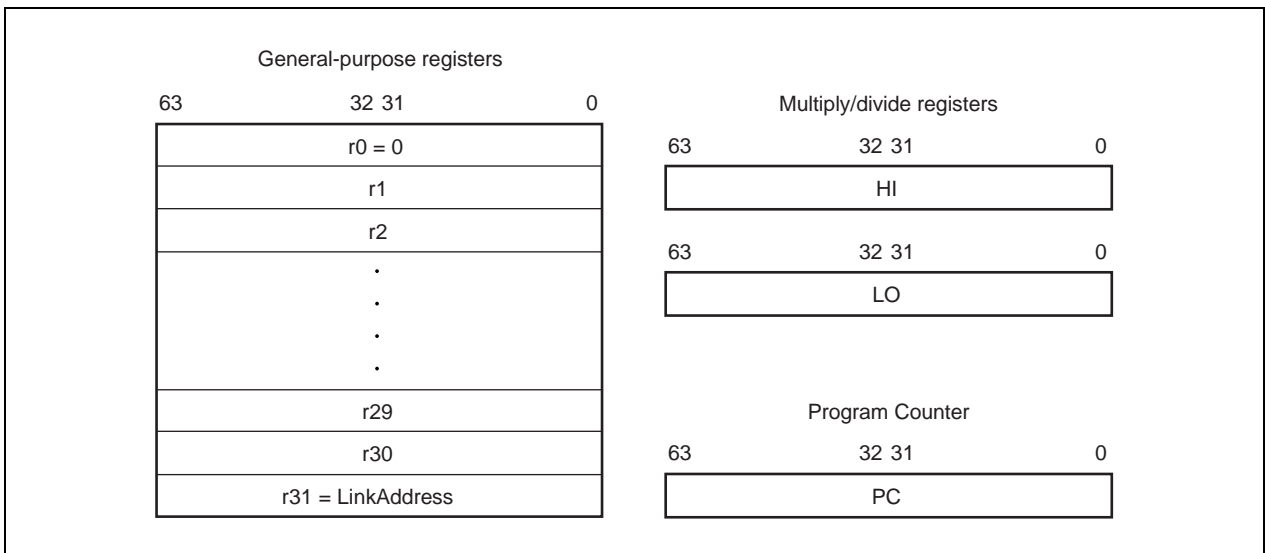

1.4.2 Coprocessors

MIPS ISA defines 4 types of coprocessors (CP0 to CP3).

- CP0 translates virtual addresses to physical addresses, switches the operating mode (kernel, supervisor, or user mode), and manages exceptions. It also controls the cache subsystem to analyze a cause and to return from the error state.
- CP1 is reserved for floating-point instructions.
- CP2 is reserved for future definition by MIPS.
- CP3 is no longer defined. CP3 instructions are reserved for future extensions.

Figure 1-4 shows the definitions of the CP0 registers, and Table 1-6 shows simple descriptions of each register. For the detailed descriptions of the registers related to the virtual system memory, refer to **CHAPTER 6 MEMORY MANAGEMENT SYSTEM**. For the detailed descriptions of the registers related to exception handling, refer to **CHAPTER 7 EXCEPTION PROCESSING**.

Figure 1-4. CP0 Registers

Register No.	Register name	Register No.	Register name
0	Index ^{Note 1}	16	Config ^{Note 1}
1	Random ^{Note 1}	17	LLAddr ^{Note 1}
2	EntryLo0 ^{Note 1}	18	WatchLo ^{Note 2}
3	EntryLo1 ^{Note 1}	19	WatchHi ^{Note 2}
4	Context ^{Note 2}	20	XContext ^{Note 2}
5	PageMask ^{Note 1}	21	RFU
6	Wired ^{Note 1}	22	RFU
7	RFU	23	RFU
8	BadVAddr ^{Note 2}	24	RFU
9	Count ^{Note 2}	25	RFU
10	EntryHi ^{Note 1}	26	Parity Error ^{Note 2}
11	Compare ^{Note 2}	27	Cache Error ^{Note 2}
12	Status ^{Note 2}	28	TagLo ^{Note 1}
13	Cause ^{Note 2}	29	TagHi ^{Note 1}
14	EPC ^{Note 2}	30	ErrorEPC ^{Note 2}
15	PRId ^{Note 1}	31	RFU

Notes 1. For memory management
2. For exception handling

Remark RFU: Reserved for Future Use

Table 1-6. System Control Coprocessor (CP0) Register Definitions

Number	Register	Description
0	Index	Programmable pointer to TLB array
1	Random	Pseudo-random pointer to TLB array (read only)
2	EntryLo0	Lower half of TLB entry for even VPN
3	EntryLo1	Lower half of TLB entry for odd VPN
4	Context	Pointer to kernel virtual PTE in 32-bit mode
5	PageMask	TLB page mask
6	Wired	Number of wired TLB entries
7	–	Reserved for future use
8	BadVAddr	Virtual address where the most recent error occurred
9	Count	Timer count
10	EntryHi	Higher half of TLB entry (including ASID)
11	Compare	Timer compare
12	Status	Status indication
13	Cause	Cause of last exception
14	EPC	Exception Program Counter
15	PRId	Processor revision identifier
16	Config	Configuration (memory mode system) specification
17	LLAddr	Reserved for future use
18	WatchLo	Memory reference trap address low bits
19	WatchHi	Memory reference trap address high bits
20	XContext	Pointer to kernel virtual PTE in 64-bit mode
21 to 25	–	Reserved for future use
26	Parity Error ^{Note}	Cache parity bits
27	Cache Error ^{Note}	Index and status of cache error
28	TagLo	Lower half of cache tag
29	TagHi	Higher half of cache tag
30	ErrorEPC	Error Exception Program Counter
31	–	Reserved for future use

Note This register is defined to maintain compatibility with the Vr4100™. This register is not used in the Vr4181 hardware.

1.4.3 Floating-point unit (FPU)

The V_R4181 does not support the floating-point unit (FPU). Coprocessor Unusable exception will occur if any FPU instructions are executed. If necessary, FPU instructions should be emulated by software in an exception handler.

1.4.4 CPU core memory management unit

The V_R4181 has a 32-bit physical addressing range of 4 GB. However, since it is rare for systems to implement a physical memory space as large as that memory space, the CPU provides a logical expansion of memory space by translating addresses composed in the large virtual address space into available physical memory addresses. The V_R4181 supports the following two addressing modes:

- 32-bit mode, in which the virtual address space is divided into 2 GB for user process and 2 GB for the kernel.
- 64-bit mode, in which the virtual address is expanded to 1 tera byte (2^{40} bytes) of user virtual address space.

A detailed description of these address spaces is given in Chapter 6.

1.4.5 Translation lookaside buffer (TLB)

Virtual memory mapping is performed using the translation lookaside buffer (TLB). The TLB converts virtual addresses to physical addresses. It runs by a full-associative method. It has 32 entries, each mapping a pair of pages having a variable size (1 KB to 256 KB).

(1) Joint TLB (JTLB)

JTLB holds both an instruction address and data address.

For fast virtual-to-physical address decoding, the V_R4181 uses a large, fully associative TLB (joint TLB) that translates 64 virtual pages to their corresponding physical addresses. The TLB is organized as 32 pairs of even-odd entries, and maps a virtual address and address space identifier (ASID) into the 4-GB physical address space.

The page size can be configured, on a per-entry basis, to map a page size of 1 KB to 256 KB. A CP0 register stores the size of the page to be mapped, and that size is entered into the TLB when a new entry is written. Thus, operating systems can provide special purpose maps; for example, a typical frame buffer can be memory-mapped using only one TLB entry.

Translating a virtual address to a physical address begins by comparing the virtual address from the processor with the physical addresses in the TLB; there is a match when the virtual page number (VPN) of the address is the same as the VPN field of the entry, and either the Global (G) bit of the TLB entry is set, or the ASID field of the virtual address is the same as the ASID field of the TLB entry.

This match is referred to as a TLB hit. If there is no match, a TLB Miss exception is taken by the processor and software is allowed to refill the TLB from a page table of virtual/physical addresses in memory.

1.4.6 Operating mode

The V_R4181 has three operating modes:

- User mode
- Supervisor mode
- Kernel mode

The manner in which memory addresses are translated or mapped depends on these operating modes. Refer to **CHAPTER 6 MEMORY MANAGEMENT SYSTEM** for details.

1.4.7 Cache

The V_R4181 chip incorporates instruction and data caches, which are independent of each other. This configuration enables high-performance pipeline operations. Both caches have a 64-bit data bus, enabling a one-clock access. These buses can be accessed in parallel. The instruction cache of the V_R4181 has a storage capacity of 4 KB, while the data cache has a capacity of 4 KB.

A detailed description of caches is given in **CHAPETE 9 CACHE MEMORY**.

1.5 Instruction Pipeline

The V_R4181 has a 5-stage instruction pipeline. Under normal circumstances, one instruction is issued each cycle. A detailed description of pipeline is provided in **CHAPTER 5 V_R4181 PIPELINE**.

1.6 Clock Interface

The V_R4181 has the following seven clocks.

- **CLKX1, CLKX2 (input)**
These are oscillation inputs of 18.432 MHz, and used to generate operation clocks for the CPU core, serial interface, and other peripheral units.
- **RTCX1, RTCX2 (input)**
These are oscillation inputs of 32.768 kHz, and used for PMU, RTC, and so on.
- **PClock (internal)**
This clock is used to control the pipeline in the V_R4110 core, and for units relating to the pipeline. This clock is generated from the clock input of CLKX1 and CLKX2 pins via the PLL. Its frequency is determined by CLKSEL(2:0) pins.
- **MasterOut (internal)**
This is a bus clock of the V_R4110 core, and used for interrupt control. The contents of the CP0's Count register are incremented synchronously with this clock.
- **TClock (internal)**
This is an operation clock for internal MBA bus and is supplied to the internal MBA modules (memory controller, LCD controller, and DMA controller). This clock is generated from PClock and its frequency is 1/1, 1/2, 1/3 or 1/4 of the PClock frequency (It is determined by internal register setting).
- **PCLK (internal)**
This clock is supplied to the internal ISA peripherals. This clock is generated from TClock (MBA clock) and its frequency is determined by internal register setting.
- **SYSCLK (internal, output)**
This clock is used as the external ISA bus clock. It is also supplied to the internal CompactFlash controller. This clock is generated from PCLK and its frequency is determined by internal register setting.

[MEMO]

CHAPTER 2 PIN FUNCTIONS

2.1 Pin Configuration

- 160-pin plastic LQFP (fine pitch) (24 × 24)

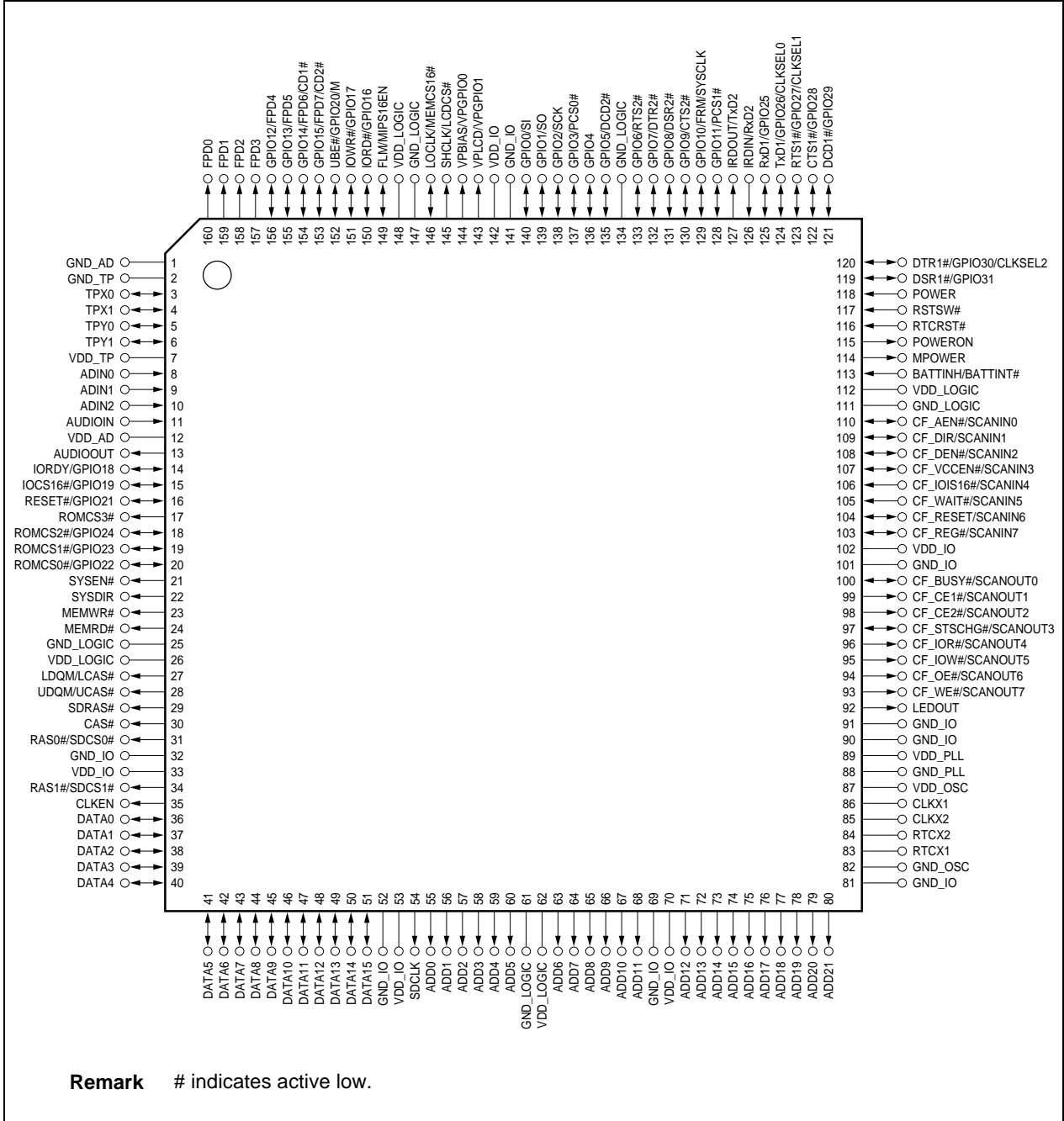

Pin Identification

ADD(21:0)	: Address Bus	LDQM	: Lower Byte Enable for SDRAM
ADIN(2:0)	: Analog Data Input	LEDOUT	: LED Output
AUDIOIN	: Audio Input	LOCLK	: Load Clock for LCD
AUDIOOUT	: Audio Output	M	: LCD Modulation Clock
BATTINH	: Battery Inhibit	MEMCS16#	: Memory 16-bit Bus Sizing
BATTINT#	: Battery Interrupt	MEMRD#	: Memory Read
CAS#	: Column Address Strobe	MEMWR#	: Memory Write
CD1#, CD2#	: Card Detect for CompactFlash	MIPS16EN	: MIPS16 Enable
CF_AEN#	: Address Enable for CompactFlash Buffer	MPOWER	: Main Power
CF_BUSY#	: Ready/Busy/Interrupt Request for CompactFlash	PCS(1:0)#	: Programmable Chip Select
CF_CE(2:1)#	: Card Enable for CompactFlash	POWER	: Power Switch
CF_DEN#	: Data Enable for CompactFlash Buffer	POWERON	: Power On State
CF_DIR	: Data Direction for CompactFlash Buffer	RAS(1:0)#	: Row Address Strobe for DRAM
CF_IOIS16#	: I/O is 16 bits for CompactFlash	RESET#	: Reset Output
CF_IOR#	: I/O Read Strobe for CompactFlash	ROMCS(3:0)#	: Chip Select for ROM
CF_LOW#	: I/O Write Strobe for CompactFlash	RSTSW#	: Reset Switch
CF_OE#	: Output Enable for CompactFlash	RTCRST#	: Real-time Clock Reset
CF_REG#	: Register Memory Access for CompactFlash	RTCX1, RTCX2	: Real-time Clock Input
CF_RESET	: Reset for CompactFlash	RTS1#, RTS2#	: Request to Send
CF_STSCHG#	: Status Change of CompactFlash	RxD1, RxD2	: Receive Data
CF_VCCEN#	: V _{CC} Enable for CompactFlash	SCANIN(7:0)	: Scan Data Input
CF_WAIT#	: Wait Input for CompactFlash	SCANOUT(7:0)	: Scan Data Output
CF_WE#	: Write Enable for CompactFlash	SCK	: CSI (Clocked Serial Interface) Clock
CLKEN	: Clock Enable for SDRAM	SDCLK	: Operation Clock for SDRAM
CLKSEL(2:0)	: Clock Select	SDCS(1:0)#	: Chip Select for SDRAM
CLKX1, CLKX2	: Clock Input	SDRAS#	: Row Address Strobe for SDRAM
CTS1#, CTS2#	: Clear to Send	SHCLK	: Shift Clock for LCD
DATA(15:0)	: Data Bus	SI	: Clocked Serial Data Input
DCD1#, DCD2#	: Data Carrier Detect	SO	: Clocked Serial Data Output
DSR1#, DSR2#	: Data Set Ready	SYSClk	: System Clock for System Bus
DTR1#, DTR2#	: Data Terminal Ready	SYSDIR	: System Data Direction
FLM	: First Line Clock for LCD	SYSEN#	: System Data Enable
FPD(7:0)	: Screen Data of LCD	TPX(1:0)	: Touch Panel Data of X
FRM	: Clocked Serial Frame	TPY(1:0)	: Touch Panel Data of Y
GND_AD	: Ground for A/D and D/A Converter	TxD1, TxD2	: Transmit Data
GND_IO	: Ground for I/O	UBE#	: Upper Byte Enable for System Bus
GND_LOGIC	: Ground for Logic	UCAS#	: Upper Column Address Strobe for DRAM
GND_OSC	: Ground for Oscillator	UDQM	: Upper Byte Enable for SDRAM
GND_PLL	: Ground for PLL	VDD_AD	: Power Supply for A/D and D/A Converter
GND_TP	: Ground for Touch Panel	VDD_IO	: Power Supply for I/O
GPIO(31:0)	: General Purpose I/O	VDD_LOGIC	: Power Supply for Logic
IOCS16#	: I/O 16-bit Bus Sizing	VDD_OSC	: Power Supply for Oscillator
IORD#	: I/O Read	VDD_PLL	: Power Supply for PLL
IORDY	: I/O Ready	VDD_TP	: Power Supply for Touch Panel
IOWR#	: I/O Write	VPBIAS	: Bias Power Control for LCD
IRDIN	: IrDA Data Input	VPGPIO(1:0)	: General Purpose Output for LCD Panel Power Control
IRDOUT	: IrDA Data Output	VPLCD	: Logic Power Control for LCD
LCAS#	: Lower Column Address Strobe		
LCDCS#	: Chip Select for LCD		

Remark # indicates active low.

2.2 Pin Function Description

Remark # indicates active low.

2.2.1 System bus interface signals

(1/2)

Signal name	I/O	Description of function
ADD(21:0) ^{Note}	O	System address bus. Used to specify address for the DRAM, ROM, flash memory, or system bus (ISA).
DATA(15:0)	I/O	System data bus. Used to transmit and receive data between the V _R 4181 and DRAM, ROM, flash memory, or system bus.
IORD# / GPIO16	I/O	System bus I/O read signal output or general-purpose I/O. It is active when the V _R 4181 accesses the system bus to read data from an I/O port when configured as IORD#.
IOWR# / GPIO17	I/O	System bus I/O write signal output or general-purpose I/O. It is active when the V _R 4181 accesses the system bus to write data to an I/O port when configured as IOWR#.
IORDY / GPIO18	I/O	System bus I/O channel ready input or general-purpose I/O. Set this signal as active when system bus controller is ready to be accessed by the V _R 4181 when configured as IORDY.
IOCS16# / GPIO19	I/O	Bus sizing request input for system bus I/O or general-purpose I/O. Set this signal as active when system bus I/O accesses data in 16-bit width, if configured as IOCS16#.
UBE# / GPIO20 / M	I/O	System bus upper byte enable output, general-purpose input, or LCD modulation output. During system bus accesses, this signal is active when the high-order byte is valid on the data bus.
RESET# / GPIO21	I/O	System bus reset output or general-purpose I/O. It is active when the V _R 4181 resets the system bus controller when configured as RESET#.

Note The ADD0 pin is internally multiplexed with different address lines.

The ADD0 pin is logically connected to the address line ADD0 inside the V_R4181 during DRAM accesses. However, during ROM or flash memory accesses, it is logically connected to the address line ADD1 inside the V_R4181. This allows providing a greater address space capacity for ROM or flash memory. However, note that the ADD0 pin of a ROM or a flash memory must be connected to the ADD0 pin of the V_R4181 when designing.

Signal name	I/O	Description of function
SYSDIR ^{Note}	O	System data buffer direction control. This signal is valid only when ROM or ISA accesses are enabled. This becomes low level during ROM or ISA read cycle, or becomes high level during ROM or ISA write cycle.
SYSEN# ^{Note}	O	System data buffer enable. This signal is valid only when ROM or ISA accesses are enabled. This becomes active during ROM or ISA cycle.
RAS(1:0)# / SDCS(1:0)#	O	EDO DRAM row address strobes or SDRAM chip select for bank 0 and bank 1.
CAS#	O	SDRAM column address strobe. Leave unconnected when using EDO DRAM.
SDRAS#	O	SDRAM row address strobe. Leave unconnected when using EDO DRAM.
UDQM / UCAS#	O	SDRAM upper byte enable or EDO DRAM upper byte column address strobe.
LDQM / LCAS#	O	SDRAM lower byte enable or EDO DRAM lower byte column address strobe.
SDCLK	O	SDRAM operating clock.
CLKEN	O	SDRAM clock enable output.
ROMCS3#	O	ROM chip select output for bank 3.
ROMCS2# / GPIO24	I/O	ROM chip select output for bank 2, or general-purpose I/O.
ROMCS1# / GPIO23	I/O	ROM chip select output for bank 1, or general-purpose I/O.
ROMCS0# / GPIO22	I/O	ROM chip select output for bank 0, or general-purpose I/O.
MEMRD#	O	Memory read signal for ROM and system bus.
MEMWR#	O	Memory write signal for ROM, DRAM and system bus.

Note The SYSEN# and SYSDIR pins control a buffer which is used to isolate the V_R4181 and SDRAM data bus from the system to prevent being affected by a system reset. When an isolation buffer is used, SYSEN# and SYSDIR function as follows;

SYSEN#	SYSDIR	Bus operation
0	0	External ISA, CompactFlash, or ROM read cycle
0	1	External ISA, CompactFlash, or Flash ROM mode write cycle
1	Don't care	External Buffer Disable DRAM read/write cycle or Hibernate mode

2.2.2 LCD interface signals

Signal name	I/O	Description of function
SHCLK / LCDCS#	O	LCD shift clock output or chip select for external LCD controller.
LOCLK / MEMCS16#	I/O	LCD load clock output or bus sizing request input for system bus memory access in 16-bit width.
FLM / MIPS16EN	I/O	This function differs depending on the operating status. <During RTC reset (input)> This signal enables use of MIPS16 instructions. 0: Disable use of MIPS16 instructions 1: Enable use of MIPS16 instructions <During normal operation (output)> LCD first line clock output.
FPD(7:4) / GPIO(15:12) ^{Note}	O	See 2.2.11 General-purpose I/O signals in this section.
FPD(3:0) ^{Note}	O	LCD screen data.
VPLCD / VPGPIO1	O	LCD logic power control. This signal may be defined as a general-purpose output when an external LCD controller is used.
VPBIAS / VPGPIO0	O	LCD bias power control. This signal may be defined as a general-purpose output when an external LCD controller is used.

Note Connection between FPD(7:0) of the V_R4181 and LCD panel data lines differs depending on the panel data width as below.

For details, refer to **CHAPTER 26 LCD CONTROLLER**.

V _R 4181	LCD Panel Data (4-bit width)	LCD Panel Data (8-bit width)
FPD0	Data Line 0	Data Line 4
FPD1	Data Line 1	Data Line 5
FPD2	Data Line 2	Data Line 6
FPD3	Data Line 3	Data Line 7
FPD4	–	Data Line 0
FPD5	–	Data Line 1
FPD6	–	Data Line 2
FPD7	–	Data Line 3

2.2.3 Initialization interface signals

Signal name	I/O	Description of function
POWER	I	V _{R4181} activation signal.
RSTSW#	I	V _{R4181} reset signal.
RTCRST#	I	Reset signal for internal Real-time clock. When power is first supplied to the system, the external agent must activate this signal.
POWERON	O	This signal indicates that the V _{R4181} is ready to operate. It becomes active when a power-on factor is detected and becomes inactive when the BATTINH/BATTINT# signal check has been completed.
MPOWER	O	This signal indicates that the V _{R4181} is operating. This signal is inactive during Hibernate mode. During this signal being inactive, turn off the 2.5-V power supply.

2.2.4 Battery monitor interface signals

Signal name	I/O	Description of function
BATTINH / BATTINT#	I	<p>This function differs depending on the state of the MPOWER pin.</p> <p><When MPOWER = 0> BATTINH function Enables or disables activation on power application.</p> <p>1: Enable activation 0: Disable activation</p> <p><When MPOWER = 1> BATTINT# function This is an interrupt signal that is output when remaining battery power is low during normal operations. The external agent checks the remaining battery power and activates this signal if voltage sufficient for operations cannot be supplied.</p>

2.2.5 Clock interface signals

Signal name	I/O	Description of function
RTCX(2:1)	–	Real-time clock (32.768 kHz) connections to crystal resonator.
CLKX(2:1)	–	Processor clock (18.432 MHz) connections to crystal resonator.

2.2.6 Touch panel interface and audio interface signals

Signal name	I/O	Description of function
TPX(1:0)	I/O	Touch panel X coordinate data. They use the voltage applied to the X coordinate and the voltage input to the Y coordinate to detect which coordinates on the touch panel are being pressed.
TPY(1:0)	I/O	Touch panel Y coordinate data. They use the voltage applied to the Y coordinate and the voltage input to the X coordinate to detect which coordinates on the touch panel are being pressed.
ADIN(2:0)	I	General-purpose analog data inputs.
AUDIOIN	I	Analog audio input.
AUDIOOUT	O	Analog audio output.

2.2.7 LED interface signals

Signal name	I/O	Description of function
LEDOUT	O	This is an output signal for lighting LEDs.

2.2.8 CompactFlash interface and keyboard interface signals

Signal name	I/O	Description of function
CF_WE# / SCANOUT7	O	CompactFlash write enable output or keyboard scan data output.
CF_OE# / SCANOUT6	O	CompactFlash output enable or keyboard scan data output.
CF_IOW# / SCANOUT5	O	CompactFlash I/O write strobe output or keyboard scan data output.
CF_IOR# / SCANOUT4	O	CompactFlash I/O read strobe output or keyboard scan data output.
CF_STSCHG# / SCANOUT3	I/O	CompactFlash status changed input or keyboard scan data output.
CF_CE(2:1)# / SCANOUT(2:1)	O	CompactFlash card enable outputs or keyboard scan data outputs.
CF_BUSY# / SCANOUT0	I/O	CompactFlash ready/busy/interrupt request indication input or keyboard scan data output.
CF_REG# / SCANIN7	I/O	CompactFlash attribute memory chip access or keyboard scan data input.
CF_RESET / SCANIN6	I/O	CompactFlash reset output or keyboard scan data input.
CF_WAIT# / SCANIN5	I	CompactFlash wait input or keyboard scan data input.
CF_IOIS16# / SCANIN4	I	CompactFlash I/O 16-bit bus input or keyboard scan data input.
CF_VCCEN# / SCANIN3	I/O	CompactFlash V _{cc} enable output or keyboard scan data input.
CF_DEN# / SCANIN2	I/O	CompactFlash data buffer enable output or keyboard scan data input.
CF_DIR / SCANIN1	I/O	CompactFlash data direction output or keyboard scan data input.
CF_AEN# / SCANIN0	I/O	CompactFlash address buffer enable output or keyboard scan data input.

2.2.9 Serial interface 1 signals

Signal name	I/O	Description of function
RxD1 / GPIO25	I/O	Serial receive data input 1 or general-purpose I/O.
TxD1 / GPIO26 / CLKSEL0	I/O	This function differs depending on the operating status. <During RTC reset (input)> This signal is used to set CPU core operation frequency clock ^{Note} . <During normal operation (input/output)> Serial transmit data output 1 or general-purpose I/O.
RTS1# / GPIO27 / CLKSEL1	I/O	This function differs depending on the operating status. <During RTC reset (input)> This signal is used to set CPU core operation frequency clock ^{Note} . <During normal operation (input/output)> Request to send output 1 or general-purpose I/O.
CTS1# / GPIO28	I/O	Clear to send input 1 or general-purpose I/O.
DCD1# / GPIO29	I/O	Data carrier detect input 1 or general-purpose I/O.
DTR1# / GPIO30 / CLKSEL2	I/O	This function differs depending on the operating status. <During RTC reset (input)> This signal is used to set CPU core operation frequency clock ^{Note} . <During normal operation (input/output)> Data terminal ready output 1 or general-purpose I/O.
DSR1# / GPIO31	I/O	Data set ready input 1 or general-purpose I/O.

Note CLKSEL(2:0) signals are used to set the frequency of the CPU core operation clock (PClock) and the internal MBA bus clock (TClock). These signals are sampled when the RTCRST# signal goes high. The relationship between the CLKSEL(2:0) pin settings and clock frequency is shown below.

CLKSEL(2:0)	CPU core operation frequency (PClock)
111	Reserved (98.1 MHz)
110	Reserved (90.6 MHz)
101	Reserved (84.1 MHz)
100	Reserved (78.5 MHz)
011	Reserved (69.3 MHz)
010	65.4 MHz
001	62.0 MHz
000	49.1 MHz

TClock is generated from PClock and its frequency is always 1/2 of the PClock frequency after RTC reset.

2.2.10 IrDA interface signals

Signal name	I/O	Description of function
IRDIN / RxD2	I	IrDA receive data input or serial receive data input 2.
IRDOUT / TxD2	O	IrDA transmit data output or serial transmit data output 2.

2.2.11 General-purpose I/O signals

Signal name	I/O	Description of function
GPIO(31:25)	I/O	See 2.2.9 Serial interface 1 signals in this section
GPIO(24:16)	I/O	See 2.2.1 System bus interface signals in this section.
GPIO15 / FPD7 / CD2#	I/O	General-purpose I/O, LCD screen data output, or CompactFlash card detect 2 input.
GPIO14 / FPD6 / CD1#	I/O	General-purpose I/O, LCD screen data output, or CompactFlash card detect 1 input.
GPIO13 / FPD5	I/O	General-purpose I/O or LCD screen data output.
GPIO12 / FPD4	I/O	General-purpose I/O or LCD screen data output.
GPIO11 / PCS1#	I/O	General-purpose I/O or programmable chip select 1.
GPIO10 / FRM / SYSCLK	I/O	General-purpose I/O, clocked serial frame input for clocked serial interface, or ISA system clock output.
GPIO9 / CTS2#	I/O	General-purpose I/O or clear to send output 2.
GPIO8 / DSR2#	I/O	General-purpose I/O or data set ready input 2.
GPIO7 / DTR2#	I/O	General-purpose I/O or data terminal ready input 2.
GPIO6 / RTS2#	I/O	General-purpose I/O or request to send output 2.
GPIO5 / DCD2#	I/O	General-purpose I/O or data carrier detect input 2.
GPIO4	I/O	General-purpose I/O.
GPIO3 / PCS0#	I/O	General-purpose I/O or programmable chip select 0.
GPIO2 / SCK	I/O	General-purpose I/O or serial clock signal for clocked serial interface.
GPIO1 / SO	I/O	General-purpose I/O or clocked serial data output signal for clocked serial interface.
GPIO0 / SI	I/O	General-purpose I/O or clocked serial data input signal for clocked serial interface.

2.2.12 Dedicated V_{DD}/GND signals

Signal name	Power supply	Description of function
VDD_PLL	2.5 V	Power supply dedicated for the PLL analog block.
GND_PLL	2.5 V	Ground dedicated for the PLL analog block.
VDD_TP	3.3 V	Power supply dedicated for the touch panel interface.
GND_TP	3.3 V	Ground dedicated for the touch panel interface.
VDD_AD	3.3 V	Power supply dedicated for the A/D and D/A converters. The voltage applied to this pin becomes the maximum value for the A/D and D/A interface signals.
GND_AD	3.3 V	Ground dedicated for the A/D and D/A converters. The voltage applied to this pin becomes the minimum value for the A/D and D/A interface signals.
VDD_OSC	3.3 V	Power supply dedicated for the oscillator.
GND_OSC	3.3 V	Ground dedicated for the oscillator.
VDD_LOGIC	2.5 V	Normally, power supply of 2.5 V
GND_LOGIC	2.5 V	Normally, ground of 2.5 V
VDD_IO	3.3 V	Normally, power supply of 3.3 V
GND_IO	3.3 V	Normally, ground of 3.3 V

Caution The Vr4181 has two types of power supplies. The 3.3 V power supply should be turned on at first. Turn on/off the 2.5 V power supply depending on the status of the MPOWER pin.

2.3 Pin Status in Specific Status

(1/3)

Signal Name	During RTCRST	After Reset by RTCRST	After Reset by Deadman's Switch or RSTSW	During Suspend mode	During Hibernate mode or Shut Down by HALTimer
ADD(21:0)	Hi-Z	0	0	Note 1	0
DATA(15:0)	Hi-Z	Hi-Z	Hi-Z	Hi-Z	Hi-Z
MEMRD#	Hi-Z	1	1	1	Hi-Z
MEMWR#	Hi-Z	1	1	1	1
RAS(1:0)# / SDCS(1:0)#	Hi-Z	1	0	0	0
UDQM / UCAS#	Hi-Z	1	0	0	0
LDQM / LCAS#	Hi-Z	1	0	0	0
CAS#	Hi-Z	1	0	0	0
SDRAS#	Hi-Z	1	0	0	0
SDCLK	Hi-Z	Run	0	0	0
CLKEN	Hi-Z	1	1	1	0
SYSDIR	Hi-Z	0	0	0	0
SYSEN#	Hi-Z	1	1	1	1
IORD# / GPIO16	–	Hi-Z	Hi-Z	1 / Note 1	Hi-Z / Note 2
IOWR# / GPIO17	–	Hi-Z	Hi-Z	1 / Note 1	Hi-Z / Note 2
IORDY / GPIO18	–	Hi-Z	Hi-Z	Note 1	Note 2
IOCS16# / GPIO19	–	Hi-Z	Hi-Z	Note 1	Note 2
UBE# / GPIO20 / M	–	Hi-Z	Hi-Z	1 / Note 1 / 0	Hi-Z / Note 2 / 0
RESET# / GPIO21	–	Hi-Z	Hi-Z	Note 1	0 / Note 2
ROMCS(2:0) / GPIO(24:22)	–	Hi-Z	Hi-Z	1 / Note 1	Hi-Z / Note 2
ROMCS3	Hi-Z	Hi-Z	1	1	Hi-Z
SHCLK / LCDCS#	Hi-Z	0	0 / 1	0 / 1	0 / Hi-Z
LOCLK / MEMCS16#	Hi-Z	0	0 / –	0 / –	0 / –
FLM / MIPS16EN	Note 3	0	0	0	0
FPD(3:0)	Hi-Z	0	0	0	0
VPLCD / VPGPIO1	Hi-Z	Hi-Z	Hi-Z	Hi-Z	Hi-Z
VPBIAS / VPGPIO0	Hi-Z	Hi-Z	Hi-Z	Hi-Z	Hi-Z
POWER	–	–	–	–	–
RTCRST#	–	–	–	–	–
RSTSW#	–	–	–	–	–

Notes 1. Maintains the state of the previous Fullspeed mode.

2. The state depends on the GPHIBSTH/GPHIBSTL register setting.
3. The input level is sampled to determine the MIPS16 instruction mode.

Remark 0: low level, 1: high level, Hi-Z: high impedance

Signal Name	During RTCRST	After Reset by RTCRST	After Reset by Deadman's Switch or RSTSW	During Suspend mode	During Hibernate mode or Shut Down by HALTimer
POWERON	–	–	0	0	0
MPOWER	0	0	1	1	0
BATTINH / BATTINT#	–	–	–	–	–
RTCX2, RTCX1	–	–	–	–	–
CLKX2, CLKX1	–	–	–	–	–
TPX(1:0)	–	1	1	Note 1	1
TPY(1:0)	–	Hi-Z	Hi-Z	Note 1	Hi-Z
ADIN(2:0)	–	–	–	–	–
AUDIOIN	–	–	–	–	–
AUDIOOUT	–	0	0	Note 1	0
CF_WE# / SCANOUT7	Hi-Z	Hi-Z	Hi-Z	Note 1	Note 2 / Hi-Z
CF_OE# / SCANOUT6	Hi-Z	Hi-Z	Hi-Z	Note 1	Note 2 / Hi-Z
CF_IOW# / SCANOUT5	Hi-Z	Hi-Z	Hi-Z	Note 1	Note 2 / Hi-Z
CF_IOR# / SCANOUT4	Hi-Z	Hi-Z	Hi-Z	Note 1	Note 2 / Hi-Z
CF_STSCHG# / SCANOUT3	Hi-Z	Hi-Z	Hi-Z	Note 1	Note 1 / Hi-Z
CF_CE(2:1)# / SCANOUT(2:1)	Hi-Z	Hi-Z	Hi-Z	Note 1	Note 2 / Hi-Z
CF_BUSY# / SCANOUT0	Hi-Z	Hi-Z	Hi-Z	Note 1	Note 1 / Hi-Z
CF_REG# / SCANIN7	Hi-Z	–	Note 1	Note 1	Note 2 / Note 1
CF_RESET / SCANIN6	Hi-Z	–	Note 1	Note 1	Note 3 / Note 1
CF_WAIT# / SCANIN5	–	–	Note 1	Note 1	–
CF_IOIS16# / SCANIN4	–	–	Note 1	Note 1	–
CF_VCCEN# / SCANIN3	Hi-Z	–	Note 1	Note 1	Note 4 / Note 1
CF_DEN# / SCANIN2	Hi-Z	–	Note 1	Note 1	1 / Note 1
CF_DIR / SCANIN1	Hi-Z	–	Note 1	Note 1	1 / Note 1
CF_AEN# / SCANIN0	Hi-Z	–	Note 1	Note 1	1 / Note 1

- Notes 1.** Maintains the state of the previous Fullspeed mode.
- 2.** When CF wake-up is enabled: Outputs high level.
When CF wake-up is disabled: Becomes high impedance.
 - 3.** When CF wake-up is enabled: Outputs low level.
When CF wake-up is disabled: Becomes high impedance.
 - 4.** When CF wake-up is enabled: Outputs low level.
When CF wake-up is disabled: Outputs high level.

Remark 0: low level, 1: high level, Hi-Z: high impedance

Signal Name	During RTCRST	After Reset by RTCRST	After Reset by Deadman's Switch or RSTSW	During Suspend mode	During Hibernate mode or Shut Down by HALTimer
RxD1 / GPIO25	–	Hi-Z	Hi-Z	Note 1	Note 1 / Note 2
TxD1 / GPIO26 / CLKSELO	Note 3	Hi-Z	Hi-Z	Note 1	Note 1 / Note 2
RTS1# / GPIO27 / CLKSEL1	Note 3	Hi-Z	Hi-Z	Note 1	Note 1 / Note 2
CTS1# / GPIO28	–	Hi-Z	Hi-Z	Note 1	Note 1 / Note 2
DCD1# / GPIO29	–	Hi-Z	Hi-Z	Note 1	Note 1 / Note 2
DTR1# / GPIO30 / CLKSEL2	Note 3	Hi-Z	Hi-Z	Note 1	Note 1 / Note 2
DSR1# / GPIO31	–	Hi-Z	Hi-Z	Note 1	Note 1 / Note 2
IRDIN / RxD2	–	–	–	–	–
IRDOUT / TxD2	Hi-Z	Hi-Z	1	Note 1	Hi-Z
GPIO(15:14) / FPD(7:6) / CD(2:1)#	–	Hi-Z	Hi-Z	Note 1 / 0 / Note 1	Note 2 / Note 1
GPIO(13:12) / FPD(5:4)	–	Hi-Z	Hi-Z	Note 1 / 0	Note 2 / Note 1
GPIO11 / PCS1#	– / Hi-Z	Hi-Z	Hi-Z / 1	Note 1 / 1	Note 2 / Hi-Z
GPIO10 / FRM / SYSCLK	– / Hi-Z	Hi-Z	Hi-Z	Note 1 / 0	Note 2 / Note 1 / Hi-Z
GPIO9 / CTS2#	–	Hi-Z	Hi-Z	Note 1	Note 2 / Note 1
GPIO8 / DSR2#	–	Hi-Z	Hi-Z	Note 1	Note 2 / Note 1
GPIO7 / DTR2#	–	Hi-Z	Hi-Z	Note 1	Note 2 / Note 1
GPIO6 / RTS2#	–	Hi-Z	Hi-Z	Note 1	Note 2 / Note 1
GPIO5 / DCD2#	–	Hi-Z	Hi-Z	Note 1	Note 2 / Note 1
GPIO4	–	Hi-Z	Hi-Z	Note 1	Note 2
GPIO3 / PCS0#	– / Hi-Z	Hi-Z	Hi-Z / 1	Note 1 / 1	Note 2 / Hi-Z
GPIO2 / SCK	–	Hi-Z	Hi-Z	Note 1	Note 2 / Note 1
GPIO1 / SO	–	Hi-Z	Hi-Z	Note 1	Note 2 / Note 1
GPIO0 / SI	–	Hi-Z	Hi-Z	Note 1	Note 2 / Note 1
LEDOUT	Hi-Z	1	Note 1	Note 1	Note 1

Notes 1. Maintains the state of previous Fullspeed mode.

2. The state depends on the GPHIBSTH/GPHIBSTL register setting.
3. The input level is sampled to determine the CPU core operation frequency.

Remark 0: low level, 1: high level, Hi-Z: high impedance

[MEMO]

CHAPTER 3 MIPS III INSTRUCTION SET SUMMARY

This chapter is an overview of the MIPS III ISA central processing unit (CPU) instruction set; refer to **CHAPTER 27 MIPS III INSTRUCTION SET DETAILS** for detailed descriptions of individual CPU instructions.

3.1 CPU Instruction Formats

Each MIPS III ISA CPU instruction consists of a single 32-bit word, aligned on a word boundary. There are three instruction formats - immediate (I-type), jump (J-type), and register (R-type) - as shown in Figure 3-1. The use of a small number of instruction formats simplifies instruction decoding, allowing the compiler to synthesize more complicated and less frequently used instruction and addressing modes from these three formats as needed.

Figure 3-1. MIPS III ISA CPU Instruction Formats

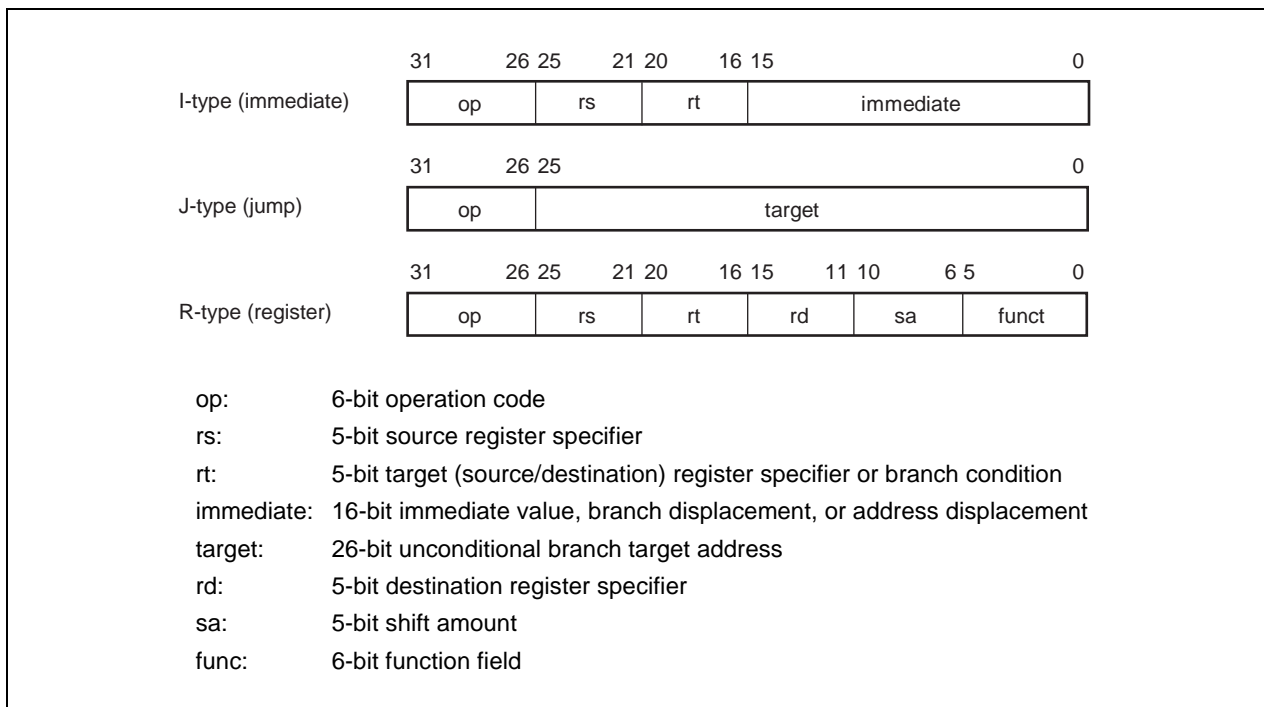

(1) Support of the MIPS ISA

The V_R4181 does not support a multiprocessor operating environment. Thus the synchronization support instructions defined in the MIPS II and MIPS III ISA - the load linked and store conditional instructions - cause reserved instruction exception. The load/link (LL) bit is eliminated.

Note that the SYNC instruction is handled as a NOP instruction since all load/store instructions in this processor are executed in program order.

3.2 Instruction Classes

The CPU instructions are classified into five classes.

3.2.1 Load and store instructions

Load and store are immediate (I-type) instructions that move data between memory and the general-purpose registers. The only addressing mode that load and store instructions directly support is base register plus 16-bit signed immediate offset.

(1) Scheduling a load delay slot

A load instruction that does not allow its result to be used by the instruction immediately following is called a delayed load instruction. The instruction slot immediately following this delayed load instruction is referred to as the load delay slot.

In the VR4000 Series™, a load instruction can be followed directly by an instruction that accesses a register that is loaded by the load instruction. In this case, however, an interlock occurs for a necessary number of cycles. Any instruction can follow a load instruction, but the load delay slot should be scheduled appropriately for both performance and compatibility with the VR Series microprocessors. For detail, see **CHAPTER 5 VR4181 PIPELINE**.

(2) Store delay slot

When a store instruction is writing data to a cache, the data cache is kept busy at the DC and WB stages. If an instruction (such as load) that follows directly the store instruction accesses the data cache in the DC stage, a hardware-driven interlock occurs. To overcome this problem, the store delay slot should be scheduled.

Table 3-1. Number of Delay Slot Cycles Necessary for Load and Store Instructions

Instruction	Necessary number of PCycles
Load	1
Store	1

(3) Defining access types

Access type indicates the size of a VR4181 processor data item to be loaded or stored, set by the load or store instruction opcode. Access types and accessed byte are shown in Table 3-2.

Regardless of access type or byte ordering (endianness), the address given specifies the low-order byte in the addressed field. For a little-endian configuration, the low-order byte is the least-significant byte.

The access type, together with the three low-order bits of the address, define the bytes accessed within the addressed doubleword (shown in Table 3-2). Only the combinations shown in Table 3-2 are permissible; other combinations cause address error exceptions.

Tables 3-2 and 3-3 list the ISA-defined load/store instructions and extended-ISA instructions, respectively.

Figure 3-2. Byte Specification Related to Load and Store Instructions

Access type (value)	Low-order address bit			Accessed byte (Little endian)								
	2	1	0	63								0
Doubleword (7)	0	0	0	7	6	5	4	3	2	1	0	
7-byte (6)	0	0	0		6	5	4	3	2	1	0	
	0	0	1	7	6	5	4	3	2	1		
6-byte (5)	0	0	0			5	4	3	2	1	0	
	0	1	0	7	6	5	4	3	2			
5-byte (4)	0	0	0				4	3	2	1	0	
	0	1	1	7	6	5	4	3				
Word (3)	0	0	0					3	2	1	0	
	1	0	0	7	6	5	4					
Triple byte (2)	0	0	0						2	1	0	
	0	0	1					3	2	1		
	1	0	0		6	5	4					
	1	0	1	7	6	5						
Halfword (1)	0	0	0							1	0	
	0	1	0					3	2			
	1	0	0			5	4					
	1	1	0	7	6							
Byte (0)	0	0	0								0	
	0	0	1							1		
	0	1	0						2			
	0	1	1					3				
	1	0	0				4					
	1	0	1			5						
	1	1	0		6							
	1	1	1	7								

Table 3-2. Load/Store Instruction

Instruction	Format and Description				
		op	base	rt	offset
Load Byte	LB rt, offset (base) The offset is sign extended and then added to the contents of the register base to form the virtual address. The bytes of the memory location specified by the address are sign extended and loaded into register rt.				
Load Byte Unsigned	LBU rt, offset (base) The offset is sign extended and then added to the contents of the register base to form the virtual address. The bytes of the memory location specified by the address are zero extended and loaded into register rt.				
Load Halfword	LH rt, offset (base) The offset is sign extended and then added to the contents of the register base to form the virtual address. The halfword of the memory location specified by the address is sign extended and loaded to register rt.				
Load Halfword Unsigned	LHU rt, offset (base) The offset is sign extended and then added to the contents of the register base to form the virtual address. The halfword of the memory location specified by the address is zero extended and loaded to register rt.				
Load Word	LW rt, offset (base) The offset is sign extended and then added to the contents of the register base to form the virtual address. The word of the memory location specified by the address is sign extended and loaded to register rt. In the 64-bit mode, it is further sign extended to 64 bits.				
Load Word Left	LWL rt, offset (base) The offset is sign extended and then added to the contents of the register base to form the virtual address. Shifts to the left the word whose address is specified so that the address-specified byte is at the left-most position of the word. The result of the shift operation is merged with the contents of register rt and loaded to register rt. In the 64-bit mode, it is further sign extended to 64 bits.				
Load Word Right	LWR rt, offset (base) The offset is sign extended and then added to the contents of the register base to form the virtual address. Shifts to the right the word whose address is specified so that the address-specified byte is at the right-most position of the word. The result of the shift operation is merged with the contents of register rt and loaded to register rt. In the 64-bit mode, it is further sign extended to 64 bits.				
Store Byte	SB rt, offset (base) The offset is sign extended and then added to the contents of the register base to form the virtual address. The least significant byte of register rt is stored to the memory location specified by the address.				
Store Halfword	SH rt, offset (base) The offset is sign extended and then added to the contents of the register base to form the virtual address. The least significant halfword of register rt is stored to the memory location specified by the address.				
Store Word	SW rt, offset (base) The offset is sign extended and then added to the contents of the register base to form the virtual address. The lower word of register rt is stored to the memory location specified by the address.				
Store Word Left	SWL rt, offset (base) The offset is sign extended and then added to the contents of the register base to form the virtual address. Shifts to the right the contents of register rt so that the left-most byte of the word is in the position of the address-specified byte. The result is stored to the lower word in memory.				
Store Word Right	SWR rt, offset (base) The offset is sign extended and then added to the contents of the register base to form the virtual address. Shifts to the left the contents of register rt so that the right-most byte of the word is in the position of the address-specified byte. The result is stored to the upper word in memory.				

Table 3-3. Load/Store Instruction (Extended ISA)

Instruction	Format and Description				
		op	base	rt	offset
Load Doubleword	LD rt, offset (base) The offset is sign extended and then added to the contents of the register base to form the virtual address. The doubleword of the memory location specified by the address are loaded into register rt.				
Load Doubleword Left	LDL rt, offset (base) The offset is sign extended and then added to the contents of the register base to form the virtual address. Shifts to the left the double word whose address is specified so that the address-specified byte is at the left-most position of the double word. The result of the shift operation is merged with the contents of register rt and loaded to register rt.				
Load Doubleword Right	LDR rt, offset (base) The offset is sign extended and then added to the contents of the register base to form the virtual address. Shifts to the right the double word whose address is specified so that the address-specified byte is at the right-most position of the double word. The result of the shift operation is merged with the contents of register rt and loaded to register rt.				
Load Word Unsigned	LWU rt, offset (base) The offset is sign extended and then added to the contents of the register base to form the virtual address. The word of the memory location specified by the address are zero extended and loaded into register rt				
Store Doubleword	SD rt, offset (base) The offset is sign extended and then added to the contents of the register base to form the virtual address. The contents of register rt are stored to the memory location specified by the address.				
Store Doubleword Left	SDL rt, offset (base) The offset is sign extended and then added to the contents of the register base to form the virtual address. Shifts to the right the contents of register rt so that the left-most byte of the double word is in the position of the address-specified byte. The result is stored to the lower doubleword in memory.				
Store Doubleword Right	SDR rt, offset (base) The offset is sign extended and then added to the contents of the register base to form the virtual address. Shifts to the left the contents of register rt so that the right-most byte of the double word is in the position of the address-specified byte. The result is stored to the upper doubleword in memory.				

3.2.2 Computational instructions

Computational instructions perform arithmetic, logical, and shift operations on values in registers. Computational instructions can be either in register (R-type) format, in which both operands are registers, or in immediate (I-type) format, in which one operand is a 16-bit immediate.

Computational instructions are classified as:

- (1) ALU immediate instructions (Tables 3-4 and 3-5)
- (2) Three-operand type instructions (Tables 3-6 and 3-7)
- (3) Shift instructions (Tables 3-8 and 3-9)
- (4) Multiply/divide instructions (Table 3-10 and 3-11)

To maintain data compatibility between the 64- and 32-bit modes, it is necessary to sign-extend 32-bit operands correctly. If the sign extension is not correct, the 32-bit operation result is meaningless.

Table 3-4. ALU Immediate Instruction

Instruction	Format and Description				
		op	rs	rt	immediate
Add Immediate	ADDI rt, rs, immediate The 16-bit immediate is sign extended and then added to the contents of register rs to form a 32-bit result. The result is stored into register rt. In the 64-bit mode, the operand must be sign extended. An exception occurs on the generation of 2's complement overflow.				
Add Immediate Unsigned	ADDIU rt, rs, immediate The 16-bit immediate is sign extended and then added to the contents of register rs to form a 32-bit result. The result is stored into register rt. In the 64-bit mode, the operand must be sign extended. No exception occurs on the generation of integer overflow.				
Set On Less Than Immediate	SLTI rt, rs, immediate The 16-bit immediate is sign extended and then compared to the contents of register rt treating both operands as signed integers. If rs is less than the immediate, the result is set to 1; otherwise, the result is set to 0. The result is stored to register rt.				
Set On Less Than Immediate Unsigned	SLTIU rt, rs, immediate The 16-bit immediate is sign extended and then compared to the contents of register rt treating both operands as unsigned integers. If rs is less than the immediate, the result is set to 1; otherwise, the result is set to 0. The result is stored to register rt.				
And Immediate	ANDI rt, rs, immediate The 16-bit immediate is zero extended and then ANDed with the contents of the register. The result is stored into register rt.				
Or Immediate	ORI rt, rs, immediate The 16-bit immediate is zero extended and then ORed with the contents of the register. The result is stored into register rt.				
Exclusive Or Immediate	XORI rt, rs, immediate The 16-bit immediate is zero extended and then Ex-ORed with the contents of the register. The result is stored into register rt.				
Load Upper Immediate	LUI rt, immediate The 16-bit immediate is shifted left by 16 bits to set the lower 16 bits of word to 0. The result is stored into register rt. In the 64-bit mode, the operand must be sign extended.				

Table 3-5. ALU Immediate Instruction (Extended ISA)

Instruction	Format and Description				
		op	rs	rt	immediate
Doubleword Add Immediate	DADDI rt, rs, immediate The 16-bit immediate is sign extended to 64 bits and then added to the contents of register rs to form a 64-bit result. The result is stored into register rt. An exception occurs on the generation of integer overflow.				
Doubleword Add Immediate Unsigned	DADDIU rt, rs, immediate The 16-bit immediate is sign extended to 64 bits and then added to the contents of register rs to form a 64-bit result. The result is stored into register rt. No exception occurs on the generation of overflow.				

Table 3-6. Three-Operand Type Instruction

Instruction	Format and Description						
		op	rs	rt	rd	sa	funct
Add	ADD rd, rs, rt The contents of registers rs and rt are added together to form a 32-bit result. The result is stored into register rd. In the 64-bit mode, the operand must be sign extended. An exception occurs on the generation of integer overflow.						
Add Unsigned	ADDU rd, rs, rt The contents of registers rs and rt are added together to form a 32-bit result. The result is stored into register rd. In the 64-bit mode, the operand must be sign extended. No exception occurs on the generation of integer overflow.						
Subtract	SUB rd, rs, rt The contents of register rt are subtracted from the contents of register rs. The 32-bit result is stored into register rd. In the 64-bit mode, the operand must be sign extended. An exception occurs on the generation of integer overflow.						
Subtract Unsigned	SUBU rd, rs, rt The contents of register rt are subtracted from the contents of register rs. The 32-bit result is stored into register rd. In the 64-bit mode, the operand must be sign extended. No exception occurs on the generation of integer overflow.						
Set On Less Than	SLT rd, rs, rt The contents of registers rs and rt are compared, treating both operands as signed integers. If the contents of register rs is less than that of register rt, the result is set to 1; otherwise, the result is set to 0. The result is stored to register rd.						
Set On Less Than Unsigned	SLTU rd, rs, rt The contents of registers rs and rt are compared treating both operands as unsigned integers. If the contents of register rs is less than that of register rt, the result is set to 1; otherwise, the result is set to 0. The result is stored to register rd.						
And	AND rd, rt, rs The contents of register rs are logical ANDed with that of general register rt bit-wise. The result is stored to register rd.						
Or	OR rd, rt, rs The contents of register rs are logical ORed with that of general register rt bit-wise. The result is stored to register rd.						
Exclusive Or	XOR rd, rt, rs The contents of register rs are logical Ex-ORed with that of general register rt bit-wise. The result is stored to register rd.						
Nor	NOR rd, rt, rs The contents of register rs are logical NORed with that of general register rt bit-wise. The result is stored to register rd.						

Table 3-7. Three-Operand Type Instruction (Extended ISA)

Instruction	Format and Description						
		op	rs	rt	rd	sa	funct
Doubleword Add	DADD rd, rt, rs The contents of register rs are added to that of register rt. The 64-bit result is stored into register rd. An exception occurs on the generation of integer overflow.						
Doubleword Add Unsigned	DADDU rd, rt, rs The contents of register rs are added to that of register rt. The 64-bit result is stored into register rd. No exception occurs on the generation of integer overflow.						
Doubleword Subtract	DSUB rd, rt, rs The contents of register rt are subtracted from that of register rs. The 64-bit result is stored into register rd. An exception occurs on the generation of integer overflow.						
Doubleword Subtract Unsigned	DSUBU rd, rt, rs The contents of register rt are subtracted from that of register rs. The 64-bit result is stored into register rd. No exception occurs on the generation of integer overflow.						

Table 3-8. Shift Instruction

Instruction	Format and Description						
		op	rs	rt	rd	sa	funct
Shift Left Logical	SLL rd, rs, sa The contents of register rt are shifted left by sa bits and zeros are inserted into the emptied lower bits. The 32-bit result is stored into register rd. In the 64-bit mode, the operand must be sign extended.						
Shift Right Logical	SRL rd, rs, sa The contents of register rt are shifted right by sa bits and zeros are inserted into the emptied higher bits. The 32-bit result is stored into register rd. In the 64-bit mode, the operand must be sign extended.						
Shift Right Arithmetic	SRA rd, rt, sa The contents of register rt are shifted right by sa bits and the emptied higher bits are sign extended. The 32-bit result is stored into register rd. In the 64-bit mode, the operand must be sign extended.						
Shift Left Logical Variable	SLLV rd, rt, rs The contents of register rt are shifted left and zeros are inserted into the emptied lower bits. The lower five bits of register rs specify the shift count. The 32-bit result is stored into register rd. In the 64-bit mode, the operand must be sign extended.						
Shift Right Logical Variable	SRLV rd, rt, rs The contents of register rt are shifted right and zeros are inserted into the emptied higher bits. The lower five bits of register rs specify the shift count. The 32-bit result is stored into register rd. In the 64-bit mode, the operand must be sign extended.						
Shift Right Arithmetic Variable	SRAV rd, rt, rs The contents of register rt are shifted right and the emptied higher bits are sign extended. The lower five bits of register rs specify the shift count. The 32-bit result is stored into register rd. In the 64-bit mode, the operand must be sign extended.						

Table 3-9. Shift Instruction (Extended ISA)

Instruction	Format and Description	op	rs	rt	rd	sa	funct
Doubleword Shift Left Logical	DSLL rd, rs, sa The contents of register rt are shifted left by sa bits and zeros are inserted into the emptied lower bits. The 64-bit result is stored into register rd.						
Doubleword Shift Right Logical	DSRL rd, rs, sa The contents of register rt are shifted right by sa bits and zeros are inserted into the emptied higher bits. The 64-bit result is stored into register rd.						
Doubleword Shift Right Arithmetic	DSRA rd, rt, sa The contents of register rt are shifted right by sa bits and the emptied higher bits are sign extended. The 64-bit result is stored into register rd.						
Doubleword Shift Left Logical Variable	DSLLV rd, rt, rs The contents of register rt are shifted left and zeros are inserted into the emptied lower bits. The lower six bits of register rs specify the shift count. The 64-bit result is stored into register rd.						
Doubleword Shift Right Logical Variable	DSRLV rd, rt, rs The contents of register rt are shifted right and zeros are inserted into the emptied higher bits. The lower six bits of register rs specify the shift count. The 64-bit result is stored into register rd.						
Doubleword Shift Right Arithmetic Variable	DSRAV rd, rt, rs The contents of register rt are shifted right and the emptied higher bits are sign extended. The lower six bits of register rs specify the shift count. The 64-bit result is stored into register rd.						
Doubleword Shift Left Logical + 32	DSLL32 rd, rt, sa The contents of register rt are shifted left by 32 + sa bits and zeros are inserted into the emptied lower bits. The 64-bit result is stored into register rd.						
Doubleword Shift Right Logical + 32	DSRL32 rd, rt, sa The contents of register rt are shifted right by 32 + sa bits and zeros are inserted into the emptied higher bits. The 64-bit result is stored into register rd.						
Doubleword Shift Right Arithmetic + 32	DSRA32 rd, rt, sa The contents of register rt are shifted right by 32 + sa bits and the emptied higher bits are sign extended. The 64-bit result is stored into register rd.						

Table 3-10. Multiply/Divide Instructions

Instruction	Format and Description	op	rs	rt	rd	sa	funct
Multiply	MULT rs, rt The contents of registers rt and rs are multiplied, treating both operands as 32-bit signed integers. The 64-bit result is stored into special registers HI and LO. In the 64-bit mode, the operand must be sign extended.						
Multiply Unsigned	MULTU rs, rt The contents of registers rt and rs are multiplied, treating both operands as 32-bit unsigned integers. The 64-bit result is stored into special registers HI and LO. In the 64-bit mode, the operand must be sign extended.						
Divide	DIV rs, rt The contents of register rs are divided by that of register rt, treating both operands as 32-bit signed integers. The 32-bit quotient is stored into special register LO, and the 32-bit remainder is stored into special register HI. In the 64-bit mode, the operand must be sign extended.						
Divide Unsigned	DIVU rs, rt The contents of register rs are divided by that of register rt, treating both operands as 32-bit unsigned integers. The 32-bit quotient is stored into special register LO, and the 32-bit remainder is stored into special register HI. In the 64-bit mode, the operand must be sign extended.						
Move From HI	MFHI rd The contents of special register HI are loaded into register rd.						
Move From LO	MFLO rd The contents of special register LO are loaded into register rd.						
Move To HI	MTHI rs The contents of register rs are loaded into special register HI.						
Move To LO	MTLO rs The contents of register rs are loaded into special register LO.						

Table 3-11. Multiply/Divide Instructions (Extended ISA) (1/2)

Instruction	Format and Description	op	rs	rt	rd	sa	funct
Doubleword Multiply	DMULT rs, rt The contents of registers rt and rs are multiplied, treating both operands as signed integers. The 128-bit result is stored into special registers HI and LO.						
Doubleword Multiply Unsigned	DMULTU rs, rt The contents of registers rt and rs are multiplied, treating both operands as unsigned integers. The 128-bit result is stored into special registers HI and LO.						
Doubleword Divide	DDIV rs, rt The contents of register rs are divided by that of register rt, treating both operands as signed integers. The 64-bit quotient is stored into special register LO, and the 64-bit remainder is stored into special register HI.						
Doubleword Divide Unsigned	DDIVU rs, rt The contents of register rs are divided by that of register rt, treating both operands as unsigned integers. The 64-bit quotient is stored into special register LO, and the 64-bit remainder is stored into special register HI.						

Table 3-11. Multiply/Divide Instructions (Extended ISA) (2/2)

Instruction	Format and Description	op	rs	rt	rd	sa	funct
Multiply and Add 16-bit Integer	MADD16 rs, rt The contents of registers rt and rs are multiplied, treating both operands as 16-bit signed integers (by sign extending to 64 bits). The result is added to the combined value of special registers HI and LO. The 64-bit result is stored into special registers HI and LO.						
Doubleword Multiply and Add 16-bit Integer	DMADD16 rs, rt The contents of registers rt and rs are multiplied, treating both operands as 16-bit signed integers (by sign extending to 64 bits). The result is added to value of special register LO. The 64-bit result is stored into special register LO.						

MFHI and MFLO instructions after a multiply or divide instruction generate interlocks to delay execution of the next instruction, inhibiting the result from being read until the multiply or divide instruction completes.

Table 3-12 gives the number of processor cycles (PCycles) required to resolve interlock or stall between various multiply or divide instructions and a subsequent MFHI or MFLO instruction.

Table 3-12. Number of Stall Cycles in Multiply and Divide Instructions

Instruction	Number of instruction cycles
MULT	1
MULTU	1
DIV	35
DIVU	35
DMULT	4
DMULTU	4
DDIV	67
DDIVU	67
MADD16	1
DMADD16	1

3.2.3 Jump and branch instructions

Jump and branch instructions change the control flow of a program. All jump and branch instructions occur with a delay of one instruction: that is, the instruction immediately following the jump or branch instruction (this is known as the instruction in the delay slot) always executes while the target instruction is being fetched from memory.

For instructions involving a link (such as JAL and BLTZAL), the return address is saved in register r31.

Table 3-13. Number of Delay Slot Cycles in Jump and Branch Instructions

Instruction	Necessary number of cycles
Branch instruction	1
Jump instruction	1

(1) Overview of jump instructions

Subroutine calls in high-level languages are usually implemented with J or JAL instructions, both of which are J-type instructions. In J-type format, the 26-bit target address shifts left 2 bits and combines with the high-order 4 bits of the current program counter to form a 32-bit or 64-bit absolute address.

Returns, dispatches, and cross-page jumps are usually implemented with the JR or JALR instructions. Both are R-type instructions that take the 32-bit or 64-bit byte address contained in one of the general-purpose registers.

For more information, refer to **CHAPTER 27 MIPS III INSTRUCTION SET DETAILS**.

(2) Overview of branch instructions

A branch instruction has a PC-related signed 16-bit offset.

Tables 3-14 through 3-16 show the lists of Jump, Branch, and Extended ISA instructions, respectively.

Table 3-14. Jump Instruction

Instruction	Format and Description	op	target
Jump	J target The contents of 26-bit target address is shifted left by two bits and combined with the high-order four bits of the PC. The program jumps to this calculated address with a delay of one instruction.		
Jump And Link	JAL target The contents of 26-bit target address is shifted left by two bits and combined with the high-order four bits of the PC. The program jumps to this calculated address with a delay of one instruction. The address of the instruction following the delay slot is stored into r31 (link register).		

Instruction	Format and Description	op	target
Jump And Link Exchange	JALX target The contents of 26-bit target address is shifted left by two bits and combined with the high-order four bits of the PC. The program jumps to this calculated address with a delay of one instruction, and then the ISA mode bit is reversed. The address of the instruction following the delay slot is stored into r31 (link register).		

Instruction	Format and Description	op	rs	rt	rd	sa	funct
Jump Register	JR rs The program jumps to the address specified in register rs with a delay of one instruction.						
Jump And Link Register	JALR rs, rd The program jumps to the address specified in register rs with a delay of one instruction. The address of the instruction following the delay slot is stored into rd.						

There are the following common restrictions for Tables 3-15 and 3-16.

(1) Branch address

All branch instruction target addresses are computed by adding the address of the instruction in the delay slot to the 16-bit offset (shifted left by 2 bits and sign-extended to 64 bits). All branches occur with a delay of one instruction.

(2) Operation when unbranched

If the branch condition does not meet in executing a Likely instruction, the instruction in its delay slot is nullified. For all other branch instructions, the instruction in its delay slot is unconditionally executed.

Remark The target instruction of the branch is fetched at the EX stage of the branch instruction. Comparison of the operands of the branch instruction and calculation of the target address is performed at phase 2 of the RF stage and phase 1 of the EX stage of the instruction. Branch instructions require one cycle of the branch delay slot defined by the architecture. Jump instructions also require one cycle of delay slot. If the branch condition is not satisfied in a branch likely instruction, the instruction in its delay slot is nullified.

There are special symbols used in the instruction formats of Tables 3-15 through 3-19.

- REGIMM : Opcode
- Sub : Sub-operation code
- CO : Sub-operation identifier
- BC : BC sub-operation code
- br : Branch condition identifier
- op : Operation code

Table 3-15. Branch Instructions

Instruction	Format and Description				
		op	rs	rt	offset
Branch On Equal	BEQ rs, rt, offset If the contents of register rs are equal to that of register rt, the program branches to the target address.				
Branch On Not Equal	BNE rs, rt, offset If the contents of register rs are not equal to that of register rt, the program branches to the target address.				
Branch On Less Than Or Equal To Zero	BLEZ rs, offset If the contents of register rs are less than or equal to zero, the program branches to the target address.				
Branch On Greater Than Zero	BGTZ rs, offset If the contents of register rs are greater than zero, the program branches to the target address.				

Instruction	Format and Description				
		REGIMM	rs	sub	offset
Branch On Less Than Zero	BLTZ rs, offset If the contents of register rs are less than zero, the program branches to the target address.				
Branch On Greater Than Or Equal To Zero	BGEZ rs, offset If the contents of register rs are greater than or equal to zero, the program branches to the target address.				
Branch On Less Than Zero And Link	BLTZAL rs, offset The address of the instruction that follows delay slot is stored to register r31 (link register). If the contents of register rs are less than zero, the program branches to the target address.				
Branch On Greater Than Or Equal To Zero And Link	BGEZAL rs, offset The address of the instruction that follows delay slot is stored to register r31 (link register). If the contents of register rs are greater than or equal to zero, the program branches to the target address.				

Instruction	Format and Description				
		COPO	BC	br	offset
Branch On Coprocessor 0 True	BC0T offset Adds the 16-bit offset (shifted left by two bits and sign extended to 32 bits) to the address of the instruction in the delay slot to calculate out the branch target address. If the conditional signal of the coprocessor 0 is true, the program branches to the target address with one-instruction delay.				
Branch On Coprocessor 0 False	BC0F offset Adds the 16-bit offset (shifted left by two bits and sign extended to 32 bits) to the address of the instruction in the delay slot to calculate out the branch target address. If the conditional signal of the coprocessor 0 is false, the program branches to the target address with one-instruction delay.				

Table 3-16. Branch Instructions (Extended ISA)

Instruction	Format and Description				
		op	rs	rt	offset
Branch On Equal Likely	BEQL rs, rt, offset If the contents of register rs are equal to that of register rt, the program branches to the target address. If the branch condition is not met, the instruction in the delay slot is discarded.				
Branch On Not Equal Likely	BNEL rs, rt, offset If the contents of register rs are not equal to that of register rt, the program branches to the target address. If the branch condition is not met, the instruction in the delay slot is discarded.				
Branch On Less Than Or Equal To Zero Likely	BLEZL rs, offset If the contents of register rs are less than or equal to zero, the program branches to the target address. If the branch condition is not met, the instruction in the delay slot is discarded.				
Branch On Greater Than Zero	BGTZL rs, offset If the contents of register rs are greater than zero, the program branches to the target address. If the branch condition is not met, the instruction in the delay slot is discarded.				

Instruction	Format and Description				
		REGIMM	rs	sub	offset
Branch On Less Than Zero Likely	BLTZL rs, offset If the contents of register rs are less than zero, the program branches to the target address. If the branch condition is not met, the instruction in the delay slot is discarded.				
Branch On Greater Than Or Equal To Zero Likely	BGEZL rs, offset If the contents of register rs are greater than or equal to zero, the program branches to the target address. If the branch condition is not met, the instruction in the delay slot is discarded.				
Branch On Less Than Zero And Link Likely	BLTZALL rs, offset The address of the instruction that follows delay slot is stored to register r31 (link register). If the contents of register rs are less than zero, the program branches to the target address. If the branch condition is not met, the instruction in the delay slot is discarded.				
Branch On Greater Than Or Equal To Zero And Link Likely	BGEZALL rs, offset The address of the instruction that follows delay slot is stored to register r31 (link register). If the contents of register rs are greater than or equal to zero, the program branches to the target address. If the branch condition is not met, the instruction in the delay slot is discarded.				

Instruction	Format and Description				
		COP0	BC	br	offset
Branch On Coprocessor 0 True Likely	BC0TL offset Adds the 16-bit offset (shifted left by two bits and sign extended to 32 bits) to the address of the instruction in the delay slot to calculate out the branch target address. If the conditional signal of the coprocessor 0 is true, the program branches to the target address with one-instruction delay. If the branch condition is not met, the instruction in the delay slot is discarded.				
Branch On Coprocessor 0 False Likely	BC0FL offset Adds the 16-bit offset (shifted left by two bits and sign extended to 32 bits) to the address of the instruction in the delay slot to calculate out the branch target address. If the conditional signal of the coprocessor 0 is false, the program branches to the target address with one-instruction delay. If the branch condition is not met, the instruction in the delay slot is discarded.				

3.2.4 Special instructions

Special instructions generate software exceptions. Their formats are R-type (Syscall, Break). The Trap instruction is available only for the V_R4000 Series. All the other instructions are available for all V_R Series.

Table 3-17. Special Instructions

Instruction	Format and Description						
		SPECIAL	rs	rt	rd	sa	funct
Synchronize	SYNC Completes the load/store instruction executing in the current pipeline before the next load/store instruction starts execution.						
System Call	SYSCALL Generates a system call exception, and then transits control to the exception handling program.						
Breakpoint	BREAK Generates a break point exception, and then transits control to the exception handling program.						

Table 3-18. Special Instructions (Extended ISA) (1/2)

Instruction	Format and Description						
		SPECIAL	rs	rt	rd	sa	funct
Trap If Greater Than Or Equal	TGE rs, rt The contents of register rs are compared with that of register rt, treating both operands as signed integers. If the contents of register rs are greater than or equal to that of register rt, an exception occurs.						
Trap If Greater Than Or Equal Unsigned	TGEU rs, rt The contents of register rs are compared with that of register rt, treating both operands as unsigned integers. If the contents of register rs are greater than or equal to that of register rt, an exception occurs.						
Trap If Less Than	TLT rs, rt The contents of register rs are compared with that of register rt, treating both operands as signed integers. If the contents of register rs are less than that of register rt, an exception occurs.						
Trap If Less Than Unsigned	TLTU rs, rt The contents of register rs are compared with that of register rt, treating both operands as unsigned integers. If the contents of register rs are less than that of register rt, an exception occurs.						
Trap If Equal	TEQ rs, rt If the contents of registers rs and rt are equal, an exception occurs.						
Trap If Not Equal	TNE rs, rt If the contents of registers rs and rt are not equal, an exception occurs.						

Table 3-18. Special Instructions (Extended ISA) (2/2)

Instruction	Format and Description	REGIMM			
		rs	sub	immediate	
Trap If Greater Than Or Equal Immediate	TGEI rs, immediate The contents of register rs are compared with 16-bit sign-extended immediate data, treating both operands as signed integers. If the contents of register rs are greater than or equal to 16-bit sign-extended immediate data, an exception occurs.				
Trap If Greater Than Or Equal Immediate Unsigned	TGEIU rs, immediate The contents of register rs are compared with 16-bit zero-extended immediate data, treating both operands as unsigned integers. If the contents of register rs are greater than or equal to 16-bit sign-extended immediate data, an exception occurs.				
Trap If Less Than Immediate	TLTI rs, immediate The contents of register rs are compared with 16-bit sign-extended immediate data, treating both operands as signed integers. If the contents of register rs are less than 16-bit sign-extended immediate data, an exception occurs.				
Trap If Less Than Immediate Unsigned	TLTIU rs, immediate The contents of register rs are compared with 16-bit zero-extended immediate data, treating both operands as unsigned integers. If the contents of register rs are less than 16-bit sign-extended immediate data, an exception occurs.				
Trap If Equal Immediate	TEQI rs, immediate If the contents of register rs and immediate data are equal, an exception occurs.				
Trap If Not Equal Immediate	TNEI rs, immediate If the contents of register rs and immediate data are not equal, an exception occurs.				

3.2.5 System control coprocessor (CP0) instructions

System control coprocessor (CP0) instructions perform operations specifically on the CP0 registers to manipulate the memory management and exception handling facilities of the processor.

Table 3-19. System Control Coprocessor (CP0) Instructions (1/2)

Instruction	Format and Description	COP0				
		sub	rt	rd	0	
Move To System Control Coprocessor	MTC0 rt, rd The word data of general-purpose register rt in the CPU are loaded into general-purpose register rd in the CP0.					
Move From System Control Coprocessor	MFC0 rt, rd The word data of general-purpose register rd in the CP0 are loaded into general-purpose register rt in the CPU.					
Doubleword Move To System Control Coprocessor 0	DMTC0 rt, rd The doubleword data of general-purpose register rt in the CPU are loaded into general-purpose register rd in the CP0.					
Doubleword Move From System Control Coprocessor 0	DMFC0 rt, rd The doubleword data of general-purpose register rd in the CP0 are loaded into general-purpose register rt in the CPU.					

Table 3-19. System Control Coprocessor (CP0) Instructions (2/2)

Instruction	Format and Description	COP0		
		CO	funct	
Read Indexed TLB Entry	TLBR The TLB entry indexed by the index register is loaded into the entryHi, entryLo0, entryLo1, or page mask register.			
Write Indexed TLB Entry	TLBWI The contents of the entryHi, entryLo0, entryLo1, or page mask register are loaded into the TLB entry indexed by the index register.			
Write Random TLB Entry	TLBWR The contents of the entryHi, entryLo0, entryLo1, or page mask register are loaded into the TLB entry indexed by the random register.			
Probe TLB For Matching Entry	TLBP The address of the TLB entry that matches with the contents of entryHi register is loaded into the index register.			
Return From Exception	ERET The program returns from exception, interrupt, or error trap.			

Instruction	Format and Description	COP0		
		CO	funct	
STANDBY	STANDBY The processor's operating mode is transited from fullspeed mode to standby mode.			
SUSPEND	SUSPEND The processor's operating mode is transited from fullspeed mode to suspend mode.			
HIBERNATE	HIBERNATE The processor's operating mode is transited from fullspeed mode to hibernate mode.			

Instruction	Format and Description	CACHE	base	op	offset
		Cache Operation	Cache op, offset (base) The 16-bit offset is sign extended to 32 bits and added to the contents of the register case, to form virtual address. This virtual address is translated to physical address with TLB. For this physical address, cache operation that is indicated by 5-bit sub-opcode is performed.		

CHAPTER 4 MIPS16 INSTRUCTION SET

4.1 Outline

If the MIPS16 ASE (Application-Specific Extension), which is an expanded function for MIPS ISA (Instruction Set Architecture), is used, system costs can be considerably reduced by lowering the memory capacity requirement of embedded hardware. MIPS16 is an instruction set that uses the 16-bit instruction length, and is compatible with MIPS I, II, III, IV, and V^{Note} instruction sets in any combination. Moreover, 32-bit instruction length binary data can be executed with the VR4181.

Note The VR4100 SeriesTM currently supports the MIPS I, II, and III instruction sets.

4.2 Features

- 16-bit length instruction format
- Reduces memory capacity requirements to lower overall system cost
- MIPS16 instructions can be used with MIPS instruction binary
- Compatibility with MIPS I, II, III, IV, and V instruction sets
- Used with switching between MIPS16 instruction length mode and 32-bit MIPS instruction length mode.
- Supports 8-bit, 16-bit, 32-bit, and 64-bit data formats
- Provides 8 general-purpose registers and special registers
- Improved code generation efficiency using special 16-bit dedicated instructions

4.3 Register Set

Tables 4-1 and 4-2 show the MIPS16 register sets. These register sets form part of the register sets that can be accessed in 32-bit instruction length mode. MIPS16 ASE can directly access 8 of the 32 registers that can be used in the 32-bit instruction length mode.

In addition to these 8 general-purpose registers, the special instructions of MIPS16 ASE reference the stack pointer register (sp), return address register (ra), condition code register (t8), and program counter (pc). sp and ra are mapped by fixing to the general-purpose registers in the 32-bit instruction length mode.

MIPS16 has 2 move instructions that are used in addressing 32 general-purpose registers.

Table 4-1. General-Purpose Registers

MIPS16 register encoding	32-bit MIPS register encoding	Symbol	Comment
0	16	s0	General-purpose register
1	17	s1	General-purpose register
2	2	v0	General-purpose register
3	3	v1	General-purpose register
4	4	a0	General-purpose register
5	5	a1	General-purpose register
6	6	a2	General-purpose register
7	7	a3	General-purpose register
N/A	24	t8	MIPS16 condition code register. BTEQZ, BTNEZ, CMP, CMPI, SLT, SLTU, SLTI, and SLTIU instructions are implicitly referenced.
N/A	29	sp	Stack pointer register
N/A	31	ra	Return address register

- Remarks**
1. The symbols are the general assembler symbols.
 2. The MIPS register encoding numbers 0 to 7 correspond to the MIPS16 binary encoding of the registers, and are used to show the relationship between this encoding and the MIPS registers. The numbers 0 to 7 are not used to reference registers, except within binary MIPS16 instructions. Registers are referenced from the assembler using the MIPS name (\$16, \$17, \$2, etc.) or the symbol name (s0, s1, v0, etc.). For example, when register number 17 is accessed with the register file, the programmer references either \$17 or s1 even if the MIPS16 encoding of this register is 001.
 3. The general-purpose registers not shown in this table cannot be accessed with a MIPS16 instruction set other than the Move instruction. The Move instruction of MIPS16 can access all 32 general-purpose registers.
 4. To reference the MIPS16 condition code registers with this manual, either T, t8, or \$24 has to be used, depending on the case. These three names reference the same physical register.

Table 4-2. Special Registers

Symbol	Description
PC	Program counter. The PC-relative Add instruction and Load instruction can access this register.
HI	The upper word of the multiply or divide result is inserted
LO	The lower word of the multiply or divide result is inserted

4.4 ISA Mode

MIPS16 ASE supports procedure calling, and returns from the MIPS16 instruction length mode or the 32-bit MIPS instruction length mode to the MIPS16 instruction length mode or the 32-bit MIPS instruction length mode.

- The JAL instruction supports calling to the same ISA.
- The JALX instruction supports calling that inverses ISA.
- The JALR instruction supports calling to either ISA.
- The JR instruction supports also returning to either ISA.

MIPS16 ASE also supports a return operation from exception processing.

- The ERET instruction, which is defined only in 32-bit instruction length mode, supports returning to ISA when an exception has not occurred.

The ISA mode bit defines the instruction length mode to be executed. If the ISA mode bit is 0, the processor executes only 32-bit MIPS instructions. If the ISA mode bit is 1, the processor executes only MIPS16 instructions.

4.4.1 Changing ISA mode bit by software

Only the JALX, JR, and JALR instructions change the ISA mode bit between the MIPS16 instruction mode and the 32-bit instruction length mode. The ISA mode bit cannot be directly overwritten by software. The JALX changes the ISA mode bit to select another ISA mode. The JR instruction and JALR instruction load the ISA mode bit from bit 0 of the general-purpose register that holds the target address. Bit 0 is not a part of the target address. Bit 0 of the target address is always 0, and no address exception is generated.

Moreover, the JAL, JALR, and JALX instructions save the ISA mode bit to bit 0 of the general-purpose register that acquires the return address. The contents of this general-purpose register are later used by the JR and JALR instruction for return and restoration of the ISA mode.

4.4.2 Changing ISA mode bit by exception

Even if an exception occurs, the ISA mode does not change. When an exception occurs, the ISA mode bit is cleared to 0 so that the exception is serviced with 32-bit code. Then the ISA mode status before the exception occurred is saved to the least significant bit of the EPC register or the error EPC register. During return from an exception, the ISA mode before the exception occurred is returned to by executing the JR or ERET instruction with the contents of this register. Moreover, the ISA mode bit is cleared to 0 after cold reset and soft reset of the CPU core, and the 32-bit instruction length mode returns to its initial state.

4.4.3 Enabling change ISA mode bit

Changing the ISA mode bit is valid only MIPS16EN is set to active when the RTCRST is selected, and the MIPS16 instruction mode is enabled. The operation of the JALX, JALR, JR, and ERET instructions in the 32-bit instruction mode, differs depending on whether the MIPS16 instruction mode is enabled or prohibited. If the MIPS16 instruction mode is prohibited, the JALX instruction generates a reserved instruction exception. The JR and JALR instructions generate an address exception when bit 0 of the source register is 1. The ERET instruction generates an address exception when bit 0 of the EPC or error EPC register is 1. If the MIPS16 instruction mode is enabled, the JALX instruction executes JAL, and the ISA mode bit is inverted. The JR and JALR instructions load the ISA mode from bit 0 of the source register. The ERET instruction loads the ISA mode from bit 0 of the EPC or error EPC register. Bit 0 of the target address is always 0, and no address exception is generated even when bit 0 of the source register is 1.

4.5 Types of Instructions

This section describes the different types of instructions, and indicates the MIPS16 instructions included in each group.

Instructions are divided into the following types.

- Load and Store instructions : Move data between memory and the general-purpose registers.
- Computational instructions : Perform arithmetic operations, logical operations, and shift operations on values in registers.
- Jump and Branch instructions: Change the control flow of a program.
- Special instructions : Break instructions and Extend instructions. Break transfers control to an exception handler. Extend enlarges the immediate field of the next instruction. Instructions that can be extended with Extend are indicated as **Note 1** in **Table 4-3 MIPS16 Instruction Set Outline**.

Table 4-3. MIPS16 Instruction Set Outline

Op	Description	Op	Description
Load and Store instructions		Multiply/Divide instructions	
LB ^{Note 1}	Load Byte	MULT	Multiply
LBU ^{Note 1}	Load Byte Unsigned	MULTU	Multiply Unsigned
LH ^{Note 1}	Load Halfword	DIV	Divide
LHU ^{Note 1}	Load Halfword Unsigned	DIVU	Divide Unsigned
LW ^{Note 1}	Load Word	MFHI	Move From HI
LWU ^{Notes 1, 2}	Load Word Unsigned	MFLO	Move From LO
LD ^{Notes 1, 2}	Load Doubleword	DMULT ^{Note 2}	Doubleword Multiply
SB ^{Note 1}	Store Byte	DMULTU ^{Note 2}	Doubleword Multiply Unsigned
SH ^{Note 1}	Store Halfword	DDIV ^{Note 2}	Doubleword Divide
SW ^{Note 1}	Store Word	DDIVU ^{Note 2}	Doubleword Divide Unsigned
SD ^{Notes 1, 2}	Store Doubleword		
		Jump/Branch instructions	
Arithmetic instructions: ALU immediate instructions		JAL	Jump and Link
LI ^{Note 1}	Load Immediate	JALX	Jump and Link Exchange
ADDIU ^{Note 1}	Add Immediate Unsigned	JR	Jump Register
DADDIU ^{Notes 1, 2}	Doubleword Add Immediate Unsigned	JALR	Jump and Link Register
SLTI ^{Note 1}	Set on Less Than Immediate	BEQZ ^{Note 1}	Branch on Equal to Zero
SLTIU ^{Note 1}	Set on Less Than Immediate Unsigned	BNEZ ^{Note 1}	Branch on Not Equal to Zero
CMPI ^{Note 1}	Compare Immediate	BTEQZ ^{Note 1}	Branch on T Equal to Zero
		BTNEZ ^{Note 1}	Branch on T Not Equal to Zero
Arithmetic instructions: 2/3 operand register instructions		B ^{Note 1}	Branch Unconditional
ADDU	Add Unsigned		
SUBU	Subtract Unsigned	Shift instructions	
DADDU ^{Note 2}	Doubleword Add Unsigned	SLL ^{Note 1}	Shift Left Logical
DSUBU ^{Note 2}	Doubleword Subtract Unsigned	SRL ^{Note 1}	Shift Right Logical
SLT	Set on Less Than	SRA ^{Note 1}	Shift Right Arithmetic
SLTU	Set on Less Than Unsigned	SLLV	Shift Left Logical Variable
CMP	Compare	SRLV	Shift Right Logical Variable
NEG	Negate	SRAV	Shift Right Arithmetic Variable
AND	AND	DSLL ^{Notes 1, 2}	Doubleword Shift Left Logical
OR	OR	DSRL ^{Notes 1, 2}	Doubleword Shift Right Logical
XOR	Exclusive OR	DSRA ^{Notes 1, 2}	Doubleword Shift Right Arithmetic
NOT	Not	DSLLV ^{Note 2}	Doubleword Shift Left Logical Variable
MOVE	Move	DSRLV ^{Note 2}	Doubleword Shift Right Logical Variable
		DSRAV ^{Note 2}	Doubleword Shift Right Arithmetic Variable
Special instructions			
EXTEND	Extend		
BREAK	Breakpoint		

Notes 1. Extendable instruction. For details, see 4.8.2 **Extend instruction**.

2. Can be used in 64-bit mode and 32-bit kernel mode.

4.6 Instruction Format

The MIPS16 instruction set has a length of 16 bits and is located at the half-word boundary. One part of Jump instructions and instructions for which the Extend instruction extends immediate become 32 bits in length, but crossing the word boundary does not represent a problem.

The instruction format is shown below. Variable subfields are indicated with lower case letters (rx, ry, rz, immediate, etc.).

In the case of special functions, constants are input to the two instruction subfields op and funct. These values are indicated by upper case mnemonics. For example, in the case of the Load Byte instruction, op is LB, and in the case of the Add instruction, op is SPECIAL, and function is ADD.

The constants of the fields used in the instruction formats are shown below.

Table 4-4. Field Definition

Field	Definition
Op	5-bit major operation code
Rx	3-bit source/destination register specification
Ry	3-bit source/destination register specification
Immediate or imm	4-bit, 5-bit, 8-bit, or 11-bit immediate value, branch displacement, or address displacement
Rz	3-bit source/destination register specification
Funct or F	Function field

I-type (immediate) instruction format

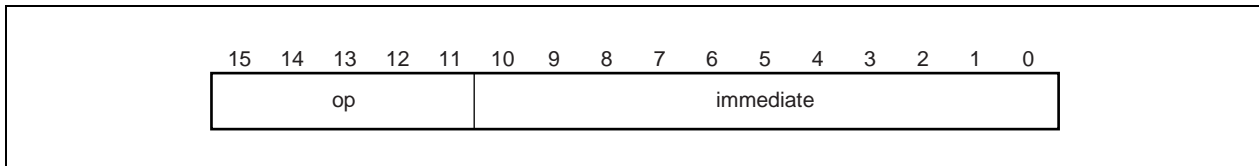

RI-type instruction format

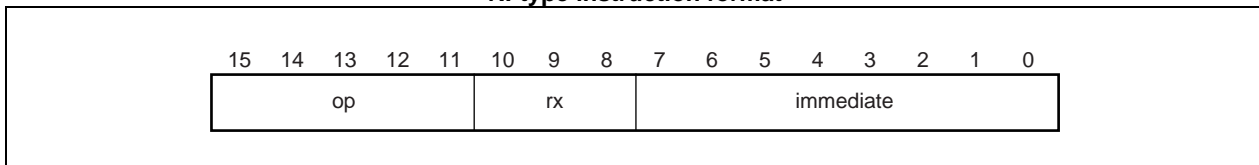

RR-type instruction format

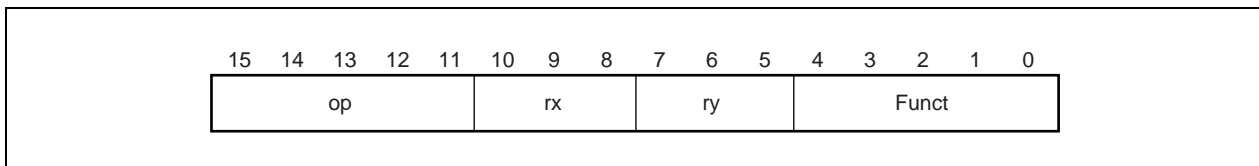

RRI-type instruction format

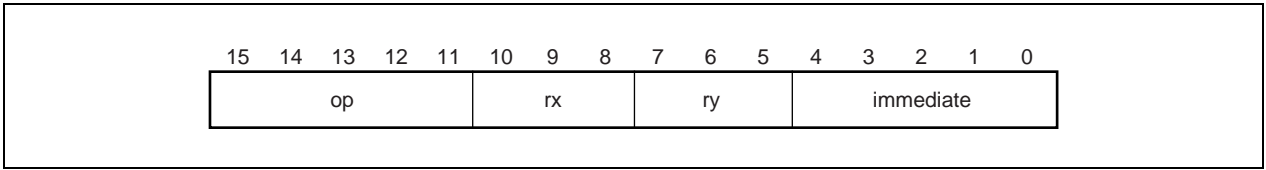

RRR-type instruction format

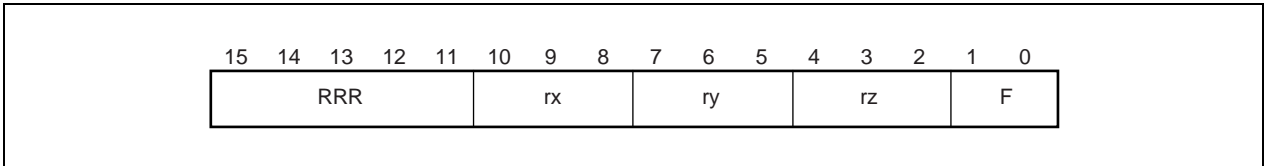

RRI-A type instruction format

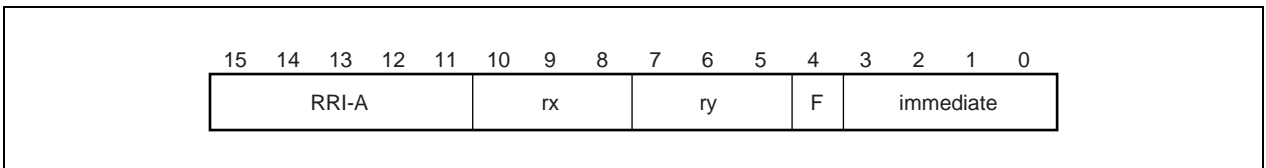

SHIFT instruction format

15	14	13	12	11	10	9	8	7	6	5	4	3	2	1	0
SHIFT					rx			ry		shamt ^{Note}			F		

Note The 3-bit shamt field can encode shift count numbers from 0 to 7. 0-bit shift (NOP) cannot be executed. 0 is regarded as shift count 8.

I8-type instruction format

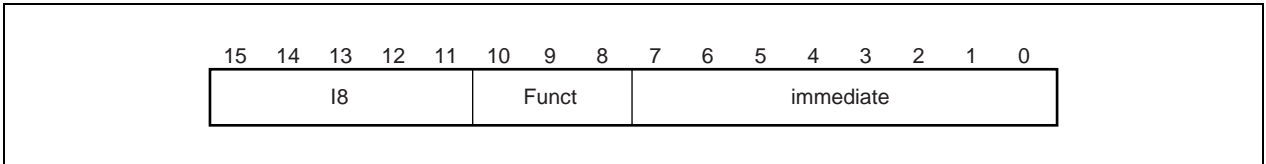

I8_MOVR32 instruction format (used only with MOVR32 instruction)

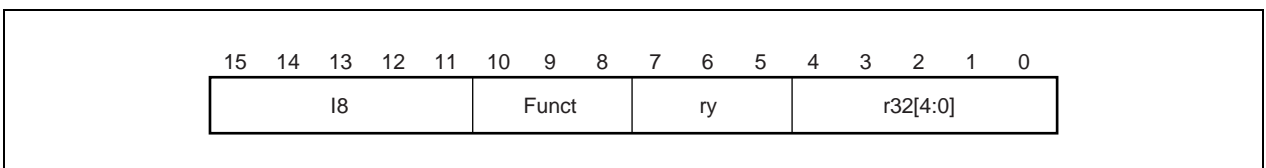

I8_MOV32R instruction format (used only with MOV32R instruction)

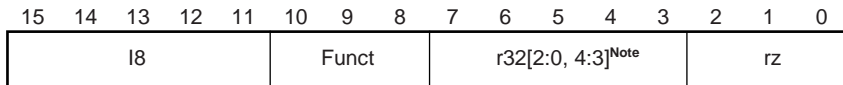

Note The r32 field uses special bit encoding. For example, encoding of \$7 (00111) is 11100 in the r32 field.

I64-type instruction format

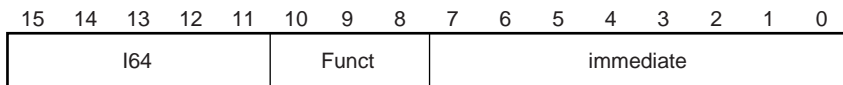

RI64-type instruction format

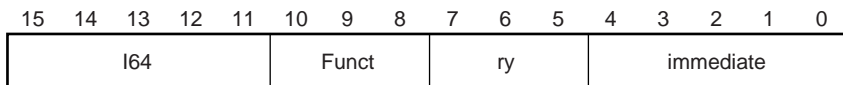

JAL and JALX instruction format

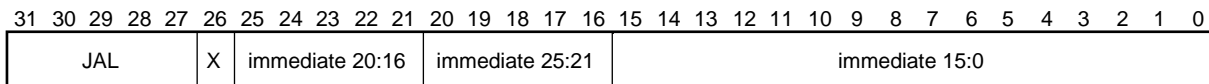

JAL in case of X = 0 instruction

JALX in case of X = 1 instruction

EXT-I instruction format

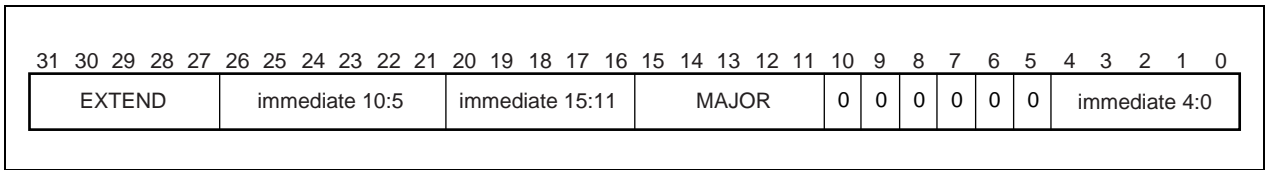

EXT-RI instruction format

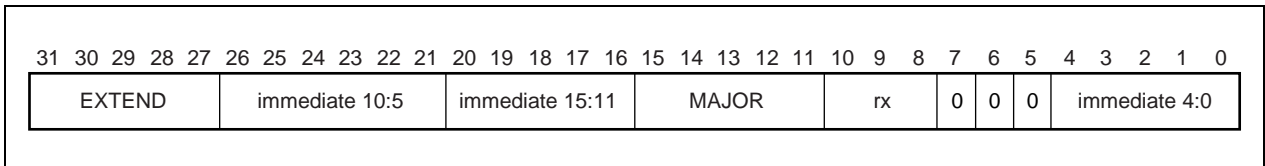

EXT-RRI instruction format

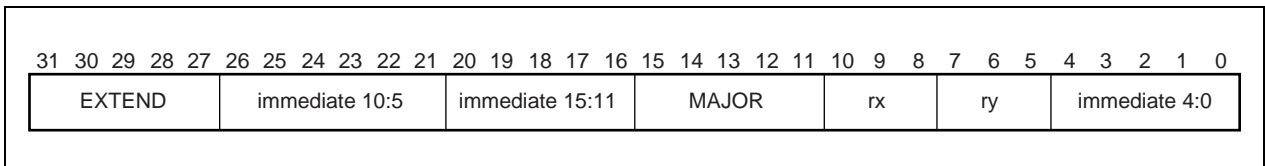

EXT-RRI-A instruction format

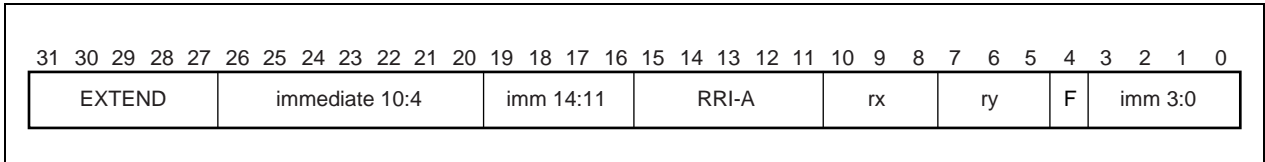

EXT-SHIFT instruction format

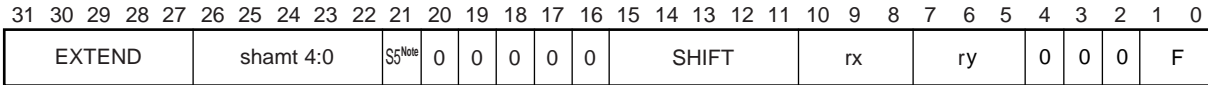

Note Only in the case of DSLL, the S5 bit is the most significant bit of the 6-bit shift count field (shamt). In the case of all 32-bit extended shifts, S5 must be 0. For a normal shift instruction, the display of shift count 0 is considered as shift count 8, but the extended shift instruction does not perform such mapping changes. Therefore, 0-bit shift using the extended format is possible.

EXT-I8 instruction format

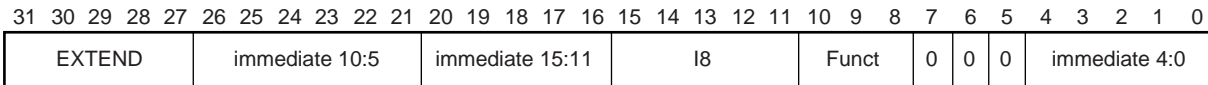

EXT-I64 instruction format

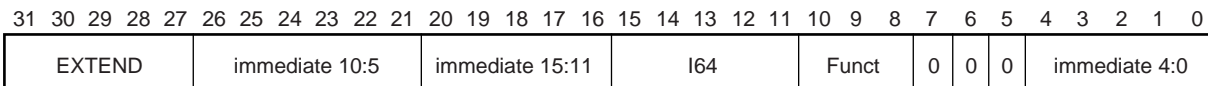

EXT-RI64 instruction format

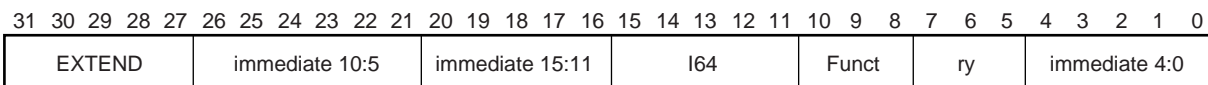

EXT-SHIFT64 instruction format

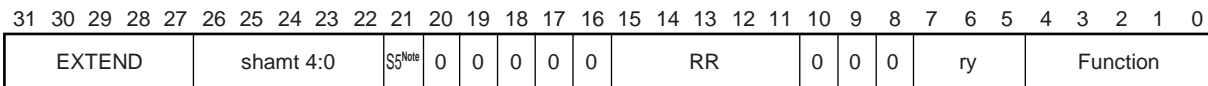

Note The S5 bit is the most significant bit of the 6-bit shift count field (shamt). In the case of a normal shift instruction, the display of shift count 0 is considered as shift count 8, but the extended shift instruction does not perform such mapping changes. Therefore, 0-bit shift using the extended format is possible.

4.7 MIPS16 Operation Code Bit Encoding

This section describes encoding for major operation code and minor operation code. Table 4-5 shows bit encoding of the MIPS16 major operation code. Tables 4-6 to 4-11 show bit encoding of the minor operation code. The italic operation codes in the tables are instructions for the extended ISA.

Table 4-5. Bit Encoding of Major Operation Code (op)

Instruction bits [15:14]	Instruction bits [13:11]							
	000	001	010	011	100	101	110	111
00	<i>addi</i> sp ^{Note 1}	<i>addi</i> pc ^{Note 2}	b	jal(x) ^{Note 3}	beqz	bnez	SHIFT	<i>ld</i>
01	RRI-A	<i>addi</i> 8 ^{Note 4}	slti	sltiu	l8	li	cmpi	<i>sd</i>
10	lb	lh	lwsp	lw	lbu	lhu	lwpc	<i>lwu</i>
11	sb	sh	swsp	sw	RRR	RR	extend	<i>l64</i>

- Notes**
1. *addi*sp : *addi* rx, sp, immediate
 2. *addi*pc : *addi* rx, pc, immediate
 3. jal(x) : jal instruction and jalx instruction
 4. *addi*8 : *addi* rx, immediate

Table 4-6. RR Minor Operation Code (RR-Type Instruction)

Instruction bits [4:3]	Instruction bits [2:0]							
	000	001	010	011	100	101	110	111
00	j(al)r ^{Note 1}	*	slt	sltu	slv	break	srlv	srav
01	<i>dsrl</i> ^{Note 2}	ϕ	cmp	neg	and	or	xor	not
10	Mfhi	*	mflo	<i>dsra</i> ^{Note 3}	<i>dsllv</i>	*	<i>dsrlv</i>	<i>dsrav</i>
11	mult	multu	div	divu	<i>dmult</i>	<i>dmultu</i>	<i>ddiv</i>	<i>ddivu</i>

- Notes**
1. J(al)r: jr rx instruction (ry = 000)
jr ra instruction (ry = 001, rx = 000)
jalr ra, rx instruction (ry = 010)
 2. *dsrl* and *dsra* use the rx register field to encode the shift count (8-digit shift for 0). In the case of the extended version of these two instructions, the EXT-SHIFT64 format is used. Only these two RR instructions can be extended.

Remarks The symbols in the figures have the following meaning.

- * : Execution of operation code with an asterisk on the current Vr4181 causes a reserved instruction exception to be generated. This code is reserved for future extension.
- ϕ : Operation code with ϕ is invalid, but no reserved instruction exception is generated in the Vr4181.

Table 4-7. RRR Minor Operation Code (RRR-Type Instruction)

Instruction bits [1:0]			
00	01	10	11
<i>daddu</i>	<i>addu</i>	<i>dsubu</i>	<i>subu</i>

Table 4-8. RRRI-A Minor Operation Code (RRI-Type ADD Instruction)

Instruction bit [4]	
0	1
<i>addiu</i> ^{Note 1}	<i>daddiu</i> ^{Note 2}

- Notes**
1. *addiu* : *addiu* ry, rx, immediate
 2. *daddiu*: *daddiu* ry, rx immediate

Table 4-9. SHIFT Minor Operation Code (SHIFT-Type Instruction)

Instruction bits [1:0]			
00	01	10	11
<i>sll</i>	<i>dSll</i>	<i>srl</i>	<i>sra</i>

Table 4-10. I8 Minor Operation Code (I8-Type Instruction)

Instruction bits [10:8]							
000	001	010	011	100	101	110	111
<i>bteqz</i>	<i>btnez</i>	<i>swrasp</i> ^{Note 1}	<i>adjsp</i> ^{Note 2}	*	<i>mov32r</i> ^{Note 3}	*	<i>movr32</i> ^{Note 4}

- Notes**
1. *swrasp* : *sw* ra, immediate(sp)
 2. *adjsp* : *addiu* sp, immediate
 3. *mov32r*: *move* r32, rz
 4. *movr32*: *move* ry, r32

Remark The symbols used in the figures have the following meaning.

- * : Execution of operation code with an asterisk on the current VR4181 causes a reserved instruction exception to be generated. This code is reserved for future extension.

Table 4-11. I64 Minor Operation Code (64-bit Only, I64-Type Instruction)

Instruction bits [10:8]							
000	001	010	011	100	101	110	111
<i>ldsp</i> ^{Note 1}	<i>sdsp</i> ^{Note 2}	<i>sdrasp</i> ^{Note 3}	<i>dadjsp</i> ^{Note 4}	<i>ldpc</i> ^{Note 5}	<i>daddiu5</i> ^{Note 6}	<i>dadiupc</i> ^{Note 7}	<i>dadiusp</i> ^{Note 8}

- Notes**
1. *ldsp* : ld ry, immediate
 2. *sdsp* : sd ry, immediate
 3. *sdrasp* : sd ra, immediate
 4. *dadjsp* : daddiu sp, immediate
 5. *ldpc* : ld ry, immediate
 6. *daddiu5*: daddiu ry, immediate
 7. *dadiupc*: daddiu ry, pc, immediate
 8. *dadiusp*: daddiu ry, sp, immediate

4.8 Outline of Instructions

This section describes the assembler syntax and defines each instruction. Instructions can be divided into the following four types.

- Load and Store instructions
- Computational instructions
- Jump and Branch instructions
- Special instructions

4.8.1 PC-relative instructions

PC-relative instructions is the instruction format first defined among the MIPS16 instruction set. MIPS16 supports both extension and non-extension through the Extend instruction for four PC-relative instructions.

Load Word	LW rx, offset(pc)
Load Doubleword	LD ry, offset(pc)
Add Immediate Unsigned	ADDIU rx, pc, immediate
Doubleword Add Immediate Unsigned	DADDIU ry, pc, immediate

All these instructions calculate the PC value of a PC-relative instruction or the PC value of the instruction immediately preceding as the base address. The address calculation base using various function combinations is shown next.

Table 4-12. Base PC Address Setting

Instruction	Base PC value
Non-extension PC-relative instructions not located in Jump delay slot	PC of instruction
Extension PC-relative instruction	PC of Extend instruction
Non-extension PC-relative instruction in Jump delay slot of JR or JALR	PC of JR instruction or JALR instruction
Non-extension PC-relative instruction in Jump delay slot of JAL or JALX	PC of initial halfword of JAL or JALX ^{Note}

Note Because the JAL and JALX instruction length is 32 bits.

The PC value used as the base for address calculation for the PC-relative instruction outlines shown in tables 4-14 and 4-15 is called base PC value. The base PC value is defined so as to be equivalent to the exception program counter (EPC) value related to the PC-relative instruction.

4.8.2 Extend instruction

The Extend instruction can extend the immediate fields of MIPS16 instructions, which have fewer immediate fields than equivalent 32-bit MIPS instructions. The Extend instruction must always precede (by one instruction) the instruction whose immediate field you want to extend. Every extended instruction consumes four bytes in program memory instead of two bytes (two bytes for Extend and two bytes for the instruction being extended), and it can cross a word boundary.

For example, the MIPS16 instruction

```
lw ry, offset (rx)
```

contains a five-bit immediate. The immediate expands to 16 bits (000000000 | offset | 00) before execution in the pipeline. This allows 32 different offset values of 0, 4, 8, and up through 124. Once extended, this instruction can hold any of the normal 65,536 values in the range -32768 through 32767 .

Shift instructions are extended to 5-bit unsigned immediate values. All other immediate instructions expand to either signed or unsigned 16-bit immediate values. The only exceptions are

```
addiu ry, rx, immediate  
daddiu ry, rx, immediate
```

which can be extended only to a 15-bit signed immediate.

There is only one restriction. Extended instructions should not be placed in jump delay slots. Otherwise, the results are unpredictable because the pipeline would attempt to execute one half the instruction.

Table 4-13 lists the MIPS16 extendable instructions, the size of their immediate, and how much each immediate can be extended when preceded with the Extend instruction.

For the instruction format of the Extend instruction, see **4.6 Instruction Format**.

Table 4-13. Extendable MIPS16 Instructions

MIPS16 Instruction	MIPS16 Immediate	Instruction Format	Extended Immediate	Instruction Format
Load Byte	5	RRI	16	EXT-RRI
Load Byte Unsigned	5	RRI	16	EXT-RRI
Load Halfword	5	RRI	16	EXT-RRI
Load Halfword Unsigned	5	RRI	16	EXT-RRI
Load Word	5 8	RRI RI	16 16	EXT-RRI EXT-RI
Load Word Unsigned	5	RRI	16	EXT-RRI
Load Doubleword	5	RRI	16	EXT-RRI
Store Byte	5	RRI	16	EXT-RRI
Store Halfword	5	RRI	16	EXT-RRI
Store Word	5 (Other) 8 (SW rx, offset(sp)) 8 (SW ra, offset(sp))	RRI RI I8	16 16 16	EXT-RRI EXT-RI EXT-I8
Store Doubleword	5 (SD ry, offset(rx)) 8 (Other)	RRI I64	16 16	EXT-RRI EXT-I64
Load Immediate	8	RI	16	EXT-RI
Add Immediate Unsigned	4 (ADDIU ry, rx, imm) 8 (ADDIU sp, imm) 8 (Other)	RRI-A I8 RI	15 16 16	EXT-RRI-A EXT-I8 EXT-RI
Doubleword Add Immediate Unsigned	4 (DADDIU ry, rx, imm) 5 (DADDIU ry, pc, imm) 8 (Other)	RRI-A RI64 I64	15 16 16	EXT-RRI-A EXT-RI64 EXT-I64
Set on Less Than Immediate	8	RI	16	EXT-RI
Set on Less Than Immediate Unsigned	8	RI	16	EXT-RI
Compare Immediate	8	RI	16	EXT-RI
Shift Left Logical	3	SHIFT	5	EXT-SHIFT
Shift Right Logical	3	SHIFT	5	EXT-SHIFT
Shift Right Arithmetic	3	SHIFT	5	EXT-SHIFT
Doubleword Shift Left Logical	3	SHIFT	6	EXT-SHIFT
Doubleword Shift Right Logical	3	RR	6	EXT-SHIFT64
Doubleword Shift Right Arithmetic	3	RR	6	EXT-SHIFT64
Branch on Equal to Zero	8	RI	16	EXT-RI
Branch on Not Equal to Zero	8	RI	16	EXT-RI
Branch on T Equal to Zero	8	I8	16	EXT-I8
Branch on T Not Equal to Zero	8	I8	16	EXT-I8
Branch Unconditional	11	I	16	EXT-I

4.8.3 Delay slots

MIPS16 instructions normally execute in one cycle. However, some instructions have special requirements that must be met to assure optimum instruction flow. The instructions include All Load, Branch, and Multiply/Divide instructions.

(1) Load delay slots

MIPS16 operates with delayed loads. This is similar to the method used by 32-bit MIPS instruction sets. If another instruction references the load destination register before the load operation is completed, one cycle occurs automatically. To assure the best performance, the compiler should always schedule load delay slots as early as possible.

(2) Branch delay slots not supported

Unlike for 32-bit MIPS instructions, there are no branch delay slots for branch instructions in MIPS16. If a branch is taken, the instruction that immediately follows the branch (instruction corresponding to 32-bit MIPS delay slot) is cancelled. There are no restrictions on the instruction that follows a branch instruction, and such instruction is executed only when a branch is not taken. Branches, jumps, and extended instructions are permitted in the instruction slot after a branch.

(3) Jump delay slots

With MIPS16, there is a delay of one cycle after each jump instruction. The processor executes any instruction in the jump delay slot before it executes the jump target instruction. Two restrictions apply to any instruction placed in the jump delay slot:

1. Do not specify a branch or jump in the delay slot.
2. Do not specify an extended instruction (32-bits) in the delay slot. Doing so will make the results unpredictable.

(4) Multiply and divide scheduling

Multiply and divide latency depends on the hardware implementation. If an MFLO or MFHI instruction references the Multiply or Divide result registers before the result is ready, the pipeline stalls until the operation is complete and the result is available. However, to assure the best performance, the compiler should always schedule Multiply and Divide instructions as early as possible.

MIPS16 requires that all MFHI and MFLO instructions be followed by two instructions that do not write to the HI or LO registers. Otherwise, the data read by MFLO or MFHI will be undefined. The Extend instruction is counted singly as one instruction.

4.8.4 Instruction details

(1) Load and store instructions

Load and Store instructions move data between memory and the general-purpose registers. The only addressing mode that is supported is the mode for adding immediate offset to the base register.

Table 4-14. Load and Store Instructions (1/3)

Instruction	Format and Description
Load Byte	<p>LB ry, offset (rx)</p> <p>The 5-bit immediate is zero extended and then added to the contents of general-purpose register rx to form the virtual address. The bytes of the memory location specified by the address are sign extended and loaded into general-purpose register ry.</p>
Load Byte Unsigned	<p>LBU ry, offset (rx)</p> <p>The 5-bit immediate is zero extended and then added to the contents of general-purpose register rx to form the virtual address. The bytes of the memory location specified by the address are zero extended and loaded into general-purpose register ry.</p>
Load Halfword	<p>LH ry, offset (rx)</p> <p>The 5-bit immediate is shifted left one bit, zero extended, and then added to the contents of general-purpose register rx to form the virtual address. The halfword of the memory location specified by the address is sign extended and loaded to general-purpose register ry.</p> <p>If the least significant bit of the address is not 0, an address error exception is generated.</p>
Load Halfword Unsigned	<p>LHU ry, offset (rx)</p> <p>The 5-bit immediate is shifted left one bit, zero extended, and then added to the contents of general-purpose register rx to form the virtual address. The halfword of the memory location specified by the address is zero extended and loaded to general-purpose register ry.</p> <p>If the least significant bit of the address is not 0, an address error exception is generated.</p>
Load Word	<p>LW ry, offset (rx)</p> <p>The 5-bit immediate is shifted left two bits, zero extended, and then added to the contents of general-purpose register rx to form the virtual address. The word of the memory location specified by the address is loaded to general-purpose register ry. In the 64-bit mode, it is further sign extended to 64 bits.</p> <p>If either of the lower two bits is not 0, an address error exception is generated.</p>
	<p>LW rx, offset (pc)</p> <p>The two lower bits of the BasePC value associated with the instruction are cleared to form the masked BasePC value. The 8-bit immediate is shifted left two bits, zero extended, and then added to the masked BasePC to form the virtual address. The contents of the word at the memory location specified by the address are loaded to general-purpose register rx. In the 64-bit mode, it is further sign extended to 64 bits.</p>
	<p>LW rx, offset (sp).</p> <p>The 8-bit immediate is shifted left two bits, zero extended, and then added to the contents of general-purpose register sp to form the virtual address. The contents of the word at the memory location specified by the address are loaded to general-purpose register rx. In the 64-bit mode, it is further sign extended to 64 bits.</p> <p>If either of the two lower bits of the address is 0, an address error exception is generated.</p>

Table 4-14. Load and Store Instructions (2/3)

Instruction	Format and Description
Load Word Unsigned	<p>LWU ry, offset (rx)</p> <p>The 5-bit immediate is shifted left two bits, zero extended to 64 bits, and then added to the contents of general-purpose register rx to form the virtual address. The word of the memory location specified by the address is zero extended and loaded to general-purpose register ry.</p> <p>If either of the two lower bits of the address is not 0, an address error exception is generated.</p> <p>This operation is defined in the 64-bit mode and the 32-bit kernel mode. When this instruction is executed in the 32-bit user/supervisor mode, a reserved instruction exception is generated.</p>
Load Doubleword	<p>LD ry, offset (rx)</p> <p>The 5-bit immediate is shifted left three bits, zero extended to 64 bits, and then added to the contents of general-purpose register rx to form the virtual address. The 64-bit doubleword of the memory location specified by the address is loaded to general-purpose register ry.</p> <p>If any of the lower three bits of the address is not 0, an address error exception is generated.</p> <p>This operation is defined in the 64-bit mode and the 32-bit kernel mode. When this instruction is executed in the 32-bit user/supervisor mode, a reserved instruction exception is generated.</p>
	<p>LD ry, offset (pc)</p> <p>The lower three bits of the base PC value related to the instruction are cleared to form the masked BasePC value.</p> <p>The 5-bit immediate is shifted left three bits, zero extended to 64 bits, and then added to the masked BasePC to form the virtual address. The 64-bit doubleword at the memory location specified by the address is loaded to general-purpose register ry.</p> <p>This operation is defined in the 64-bit mode and the 32-bit kernel mode. When this instruction is executed in the 32-bit user/supervisor mode, a reserved instruction exception is generated.</p>
	<p>LD ry, offset (sp)</p> <p>The 5-bit immediate is shifted left three bits, zero extended to 64 bits, and added to the contents of general-purpose register sp to form the virtual address. The 64-bit doubleword at the memory location specified by the address is loaded to general-purpose register ry.</p> <p>If any of the three lower bits of the address is not 0, an address error exception is generated.</p> <p>This operation is defined in the 64-bit mode and the 32-bit kernel mode. When this instruction is executed in the 32-bit user/supervisor mode, a reserved instruction exception is generated.</p>

Table 4-14. Load and Store Instructions (3/3)

Instruction	Format and Description
Store Byte	<p>SB ry, offset (rx)</p> <p>The 5-bit immediate is zero extended and then added to the contents of general-purpose register rx to form the virtual address. The least significant byte of general-purpose register ry is stored to the memory location specified by the address.</p>
Store Halfword	<p>SH ry, offset (rx)</p> <p>The 5-bit immediate is shifted left one bit, zero extended, and then added to the contents of general-purpose register rx to form the virtual address. The lower halfword of general-purpose register ry is stored to the memory location specified by the address.</p> <p>If the least significant bit of the address is not 0, an address error exception is generated.</p>
Store Word	<p>SW ry, offset (rx)</p> <p>The 5-bit immediate is shifted left two bits, zero extended, and then added to the contents of general-purpose register rx to form a virtual address. The contents of general-purpose register ry are stored to the memory location specified by the address. If either of the two lower bits of the address is not 0, an address error exception is generated.</p>
	<p>SW rx, offset (sp)</p> <p>The 8-bit immediate is shifted left two bits, zero extended, and then added to the contents of general-purpose register sp to form the virtual address. The contents of general-purpose register rx are stored to the memory location specified by the address. If either of the two lower bits of the address is not 0, an address error exception is generated.</p>
	<p>SW ra, offset (sp)</p> <p>The 8-bit immediate is shifted left two bits, zero extended, and then added to the contents of general-purpose register sp to form the virtual address. The contents of general-purpose register ra are stored to the memory location specified by the address. If either of the two lower bits of the address is not 0, an address error exception is generated.</p>
Store Doubleword	<p>SD ry, offset (rx)</p> <p>The 5-bit immediate is shifted left three bits, zero extended to 64 bits, and then added to the contents of general-purpose register rx to form the virtual address. The 64 bits of general-purpose register ry are stored to the memory location specified by the address. If any of the lower three bits of the address is not 0, an address error exception is generated.</p> <p>This operation is defined in the 64-bit mode and the 32-bit kernel mode. When this instruction is executed in the 32-bit user/supervisor mode, a reserved instruction exception is generated.</p>
	<p>SD ry, offset (sp)</p> <p>The 5-bit immediate is shifted left three bits, zero extended to 64 bits, and then added to the contents of general-purpose register sp to form the virtual address. The 64 bits of general-purpose register ry are stored to the memory location specified by the address.</p> <p>If any of the lower three bits of the address is not 0, an address error exception is generated.</p> <p>This operation is defined in the 64-bit mode and the 32-bit kernel mode. When this instruction is executed in the 32-bit user/supervisor mode, a reserved instruction exception is generated.</p>
	<p>SD ra, offset (sp).</p> <p>The 8-bit immediate is shifted left three bits, zero extended to 64 bits, and then added to the contents of general-purpose register sp to form the virtual address. The 64 bits of general-purpose register ra are stored to the memory location specified by the memory. If any of the three lower bits of the address is not 0, an address error exception is generated.</p> <p>This operation is defined in the 64-bit mode and the 32-bit kernel mode. When this instruction is executed in the 32-bit user/supervisor mode, a reserved instruction exception is generated.</p>

(2) Computational instructions

Computational instructions perform arithmetic, logical, and shift operations on values in registers. There are four categories of Computational instructions: ALU Immediate, Two/Three-Operand Register-Type, Shift, and Multiply/Divide.

Table 4-15. ALU Immediate Instructions (1/2)

Instruction	Format and Description
Load Immediate	LI rx, immediate The 8-bit immediate is zero extended and loaded to general-purpose register rx.
Add Immediate Unsigned	ADDIU ry, rx, immediate The 4-bit immediate is sign extended and then added to the contents of general-purpose register rx to form a 32-bit result. The result is placed into general-purpose register ry. No integer overflow exception occurs under any circumstances. In the 64-bit mode, the operand must be a 64-bit value formed by sign-extending a 32-bit value.
	ADDIU rx, immediate The 8-bit immediate is sign extended and then added to the contents of general-purpose register rx to form a 32-bit result. The result is placed into general-purpose register rx. No integer overflow exception occurs under any circumstances. In the 64-bit mode, the operand must be a 64-bit value formed by sign-extending a 32-bit value.
	ADDIU sp, immediate The 8-bit immediate is shifted left three bits, sign extended, and then added to the contents of general-purpose register sp to form a 32-bit result. The result is placed into general-purpose register sp. No integer overflow exception occurs under any circumstances. In the 64-bit mode, the operand must be a 64-bit value formed by sign-extending a 32-bit value.
	ADDIU rx, pc, immediate The two lower bits of the BasePC value associated with the instruction are cleared to form the masked BasePC value. The 8-bit immediate is shifted left two bits, zero extended, and then added to the masked BasePC value to form the virtual address. This address is placed into general-purpose register rx. No integer overflow exception occurs under any circumstances.
	ADDIU rx, sp, immediate The 8-bit immediate is shifted left two bits, zero extended, and then added to the contents of register sp to form a 32-bit result. The result is placed into general-purpose register rx. No integer overflow exception occurs under any circumstance. In the 64-bit mode, the operand must be a 64-bit value formed by sign-extending a 32-bit value.

Table 4-15. ALU Immediate Instructions (2/2)

Instruction	Format and Description
Doubleword Add Immediate Unsigned	<p>DADDIU ry, rx, immediate</p> <p>The 4-bit immediate is sign extended to 64 bits, and then added to the contents of register rx to form a 64-bit result. The result is placed into general-purpose register ry. No integer overflow exception occurs under any circumstances.</p> <p>This operation is defined in the 64-bit mode and the 32-bit kernel mode. When this instruction is executed in the 32-bit user/supervisor mode, a reserved instruction exception is generated.</p>
	<p>DADDIU ry, immediate</p> <p>The 5-bit immediate is sign extended to 64 bits, and then added to the contents of register ry to form a 64-bit result. The result is placed into general-purpose register ry. No integer overflow exception occurs under any circumstances.</p> <p>This operation is defined in the 64-bit mode and the 32-bit kernel mode. When this instruction is executed in the 32-bit user/supervisor mode, a reserved instruction exception is generated.</p>
	<p>DADDIU sp, immediate</p> <p>The 8-bit immediate is shifted left three bits, sign extended to 64 bits, and then added to the contents of register sp to form a 64-bit result. The result is placed into general-purpose register sp. No integer overflow exception occurs under any circumstances.</p> <p>This operation is defined in the 64-bit mode and the 32-bit kernel mode. When this instruction is executed in the 32-bit user/supervisor mode, a reserved instruction exception is generated.</p>
	<p>DADDIU ry, pc, immediate</p> <p>The two lower bits of the BasePC value associated with the instruction are cleared to form the masked BasePC value. The 5-bit immediate is shifted left two bits, zero extended, and added to the masked BasePC value to form the virtual address. This address is placed into general-purpose register ry. No integer overflow exception occurs under any circumstances.</p> <p>This operation is defined in the 64-bit mode and the 32-bit kernel mode. When this instruction is executed in the 32-bit user/supervisor mode, a reserved instruction exception is generated.</p>
	<p>DADDIU ry, sp, immediate</p> <p>The 5-bit immediate is shifted left two bits, zero extended to 64 bits, and then added to the contents of register sp to form a 64-bit result. This result is placed into register ry. No integer overflow exception occurs under any circumstances.</p> <p>This operation is defined in the 64-bit mode and the 32-bit kernel mode. When this instruction is executed in the 32-bit user/supervisor mode, a reserved instruction exception is generated.</p>
Set on Less Than Immediate	<p>SLTI rx, immediate</p> <p>The 8-bit immediate is zero extended and subtracted from the contents of general-purpose register rx. Considering both quantities as signed integers, if rx is less than the zero-extended immediate, the result is set to 1; otherwise, the result is set to 0. The result is placed into register T (\$24).</p>
Set on Less Than Immediate Unsigned	<p>SLTIU rx, immediate</p> <p>The 8-bit immediate is zero extended and subtracted from the contents of general-purpose register rx. Considering both quantities as signed integers, if rx is less than the zero-extended immediate, the result is set to 1; otherwise, the result is set to 0. The result is placed into register T (\$24).</p>
Compare Immediate	<p>CMPI rx, immediate</p> <p>The 8-bit immediate is zero extended and exclusive ORed in 1-bit units with the contents of general-purpose register rx. The result is placed into register T (\$24).</p>

Table 4-16. Two-/Three-Operand Register Type (1/2)

Instruction	Format and Description
Add Unsigned	<p>ADDU rz, rx, ry</p> <p>The contents of general-purpose registers rx and ry are added together to form a 32-bit result. The result is placed into general-purpose register rz. No integer overflow exception occurs under any circumstances. In the 64-bit mode, the operand must be a 64-bit value formed by sign-extending a 32-bit value.</p>
Subtract Unsigned	<p>SUBU rz, rx, ry</p> <p>The contents of general-purpose register ry are subtracted from the contents of general-purpose register rx. The 32-bit result is placed into general-purpose register rz. No integer overflow exception occurs under any circumstances. In the 64-bit mode, the operand must be a 64-bit value formed by sign-extending a 32-bit value.</p>
Doubleword Add Unsigned	<p>DADDU rz, rx, ry</p> <p>The contents of general-purpose register ry are added to the contents of general-purpose register rx. The 64-bit result is placed into register rz. No integer overflow exception occurs under any circumstances.</p> <p>This operation is defined in the 64-bit mode and the 32-bit kernel mode. When this instruction is executed in the 32-bit user/supervisor mode, a reserved instruction exception is generated.</p>
Doubleword Subtract Unsigned	<p>DSUBU rz, rx, ry</p> <p>The contents of general-purpose register ry are subtracted from the contents of general-purpose register rx. The 64-bit result is placed into general-purpose register rz. No integer overflow exception occurs under any circumstances.</p> <p>This operation is defined in the 64-bit mode and the 32-bit kernel mode. When this instruction is executed in the 32-bit user/supervisor mode, a reserved instruction exception is generated.</p>
Set on Less Than	<p>SLT rx, ry</p> <p>The contents of general-purpose register ry are subtracted from the contents of general-purpose register rx. Considering both quantities as signed integers, if the contents of rx are less than the contents of ry, the result is set to 1; otherwise, the result is set to 0. The result is placed into register T (\$24).</p> <p>No integer overflow exception occurs. The comparison is valid even if the subtraction overflows.</p>
Set on Less Than Unsigned	<p>SLTU rx, ry</p> <p>The contents of general-purpose register ry are subtracted from the contents of general-purpose register rx. Considering both quantities as unsigned integers, if the contents of rx are less than the contents of ry, the result is set to 1; otherwise, the result is set to 0. The result is placed in register T (\$24).</p> <p>No integer overflow exception occurs. The comparison is valid even if the subtraction overflows.</p>

Table 4-16. Two-/Three-Operand Register Type (2/2)

Instruction	Format and Description
Compare	CMP rx, ry The contents of general-purpose register ry are Exclusive-ORed with the contents of general-purpose register rx. The result is placed into register T (\$24).
Negate	NEG rx, ry The contents of general-purpose register ry are subtracted from zero to form a 32-bit result. The result is placed in general-purpose register rx.
AND	AND rx, ry The contents of general-purpose register ry are logical ANDed with the contents of general-purpose register rx in 1-bit units. The result is placed in general-purpose register rx.
OR	OR rx, ry The contents of general-purpose register ry are logical ORed with the contents of general-purpose register ry. The result is placed in general-purpose register rx.
Exclusive OR	XOR rx, ry The contents of general-purpose register ry are Exclusive-ORed with the contents of general-purpose register rx in 1-bit units. The result is placed in general-purpose register rx.
NOT	NOT rx, ry The contents of general-purpose register ry are inverted in 1-bit units and placed in general-purpose register rx.
Move	MOVE ry, r32 The contents of general-purpose register r32 are moved to general-purpose register ry. R32 can specify any one of the 32 general-purpose registers.
Move	MOVE r32, rz The contents of general-purpose register rz are moved to general-purpose register r32. r32 can specify any one of the 32 general-purpose registers

Table 4-17. Shift Instructions (1/2)

Instruction	Format and Description
Shift Left Logical	<p>SLL rx, ry, immediate</p> <p>The 32-bit contents of general-purpose register ry are shifted left and zeros are inserted into the emptied low-order bits. The 3-bit immediate specifies the shift count. A shift count of 0 is interpreted as a shift count of 8. The result is placed in general-purpose register rx. In the 64-bit mode, the value that is formed by sign-extending shifted 32-bit value is stored as the result.</p>
Shift Right Logical	<p>SLR rx, ry, immediate</p> <p>The 32-bit contents of general-purpose register ry are shifted right, and zeros are inserted into the emptied high-order bits. The 3-bit immediate specifies the shift count. A shift count of 0 is interpreted as a shift count of 8. The result is placed in general-purpose register rx. In the 64-bit mode, the value that is formed by sign-extending shifted 32-bit value is stored as the result.</p>
Shift Right Arithmetic	<p>SRA rx, ry, immediate</p> <p>The 32-bit contents of general-purpose register ry are shifted right and the emptied high-order bits are sign extended. The 3-bit immediate specifies the shift count. A shift count of 0 is interpreted as a shift count of 8. In the 64-bit mode, the value that is formed by sign-extending shifted 32-bit value is stored as the result.</p>
Shift Left Logical Variable	<p>SLLV ry, rx</p> <p>The 32-bit contents of general-purpose register ry are shifted left, and zeros are inserted into the emptied low-order bits. The five low-order bits of general-purpose register rx specify the shift count. The result is placed in general-purpose register ry. In the 64-bit mode, the value that is formed by sign-extending shifted 32-bit value is stored as the result.</p>
Shift Right Logical Variable	<p>SRLV ry, rx</p> <p>The 32-bit contents of general-purpose register ry are shifted right, and the emptied high-order bits are sign extended. The five lower-order bits of general-purpose register rx specify the shift count. The register is placed in general-purpose register ry. In the 64-bit mode, the value that is formed by sign-extending shifted 32-bit value is stored as the result.</p>
Shift Right Arithmetic Variable	<p>SRAV ry, rx</p> <p>The 32-bit contents of general-purpose register ry are shifted right, and the emptied high-order bits are sign extended. The five low-order bits of general-purpose register rx specify the shift count. The result is placed in general-purpose register ry. In the 64-bit mode, the value that is formed by sign-extending shifted 32-bit value is stored as the result.</p>

Table 4-17. Shift Instructions (2/2)

Instruction	Format and Description
Doubleword Shift Left Logical	<p>DSLL rx, ry, immediate</p> <p>The 64-bit doubleword contents of general-purpose register ry are shifted left, and zeros are inserted into the emptied low-order bits. The 3-bit immediate specifies the shift count. A shift count of 0 is interpreted as a shift count of 8. The 64-bit result is placed in general-purpose register rx.</p> <p>This operation is defined in the 64-bit mode and the 32-bit kernel mode. When this instruction is executed in the 32-bit user/supervisor mode, a reserved instruction exception is generated.</p>
Doubleword Shift Right Logical	<p>DSRL ry, immediate</p> <p>The 64-bit doubleword contents of general-purpose register ry are shifted right, and zeros are inserted into the emptied high-order bits. The 3-bit immediate specifies the shift count. A shift count of 0 is interpreted as a shift count of 8.</p> <p>This operation is defined in the 64-bit mode and the 32-bit kernel mode. When this instruction is executed in the 32-bit user/supervisor mode, a reserved instruction exception is generated.</p>
Doubleword Shift Right Arithmetic	<p>DSRA ry, immediate</p> <p>The 64-bit doubleword contents of general-purpose register ry are shifted right, and the emptied high-order bits are sign extended. The 3-bit immediate specifies the shift count. A shift count of 0 is interpreted as a shift count of 8.</p> <p>This operation is defined in the 64-bit mode and the 32-bit kernel mode. When this instruction is executed in the 32-bit user/supervisor mode, a reserved instruction exception is generated.</p>
Doubleword Shift Left Logical Variable	<p>DSLLV ry, rx</p> <p>The 64-bit doubleword contents of general-purpose register ry are shifted left, and zeros are inserted into the emptied low-order bits. The six low-order bits of general-purpose register rx specify the shift count. The result is placed in general-purpose register ry.</p> <p>This operation is defined in the 64-bit mode and the 32-bit kernel mode. When this instruction is executed in the 32-bit user/supervisor mode, a reserved instruction exception is generated.</p>
Doubleword Shift Right Logical Variable	<p>DSRLV ry, rx</p> <p>The 64-bit doubleword contents of general-purpose register ry are shifted right, and zeros are inserted into the emptied high-order bits. The six low-order bits of general-purpose register rx specify the shift count. The result is placed in general-purpose register ry.</p> <p>This operation is defined in the 64-bit mode and the 32-bit kernel mode. When this instruction is executed in the 32-bit user/supervisor mode, a reserved instruction exception is generated.</p>
Doubleword Shift Right Arithmetic Variable	<p>DSRAV ry, rx</p> <p>The 64-bit doubleword contents of general-purpose register ry are shifted right, and the emptied high-order bits are sign extended. The six low-order bits of general-purpose register rx specify the shift count. The result is placed in general-purpose register ry.</p> <p>This operation is defined in the 64-bit mode and the 32-bit kernel mode. When this instruction is executed in the 32-bit user/supervisor mode, a reserved instruction exception is generated.</p>

Table 4-18. Multiply/Divide Instructions (1/2)

Instruction	Format and Description
Multiply	<p>MULT rx, ry</p> <p>The contents of general-purpose registers rx and ry are multiplied, treating both operands as 32-bit two's complement values. No integer overflow exception occurs.</p> <p>In the 64-bit mode, the operand must be a 64-bit value formed by sign-extending a 32-bit value. The low-order 32-bit word of the result are placed in special register LO, and the high-order 32-bit word is placed in special register HI. In the 64-bit mode, each result is sign extended and then stored.</p> <p>If either of the two immediately preceding instructions is MFHI or MFLO, their transfer instruction execution result becomes undefined. To obtain the correct result, insert two or more other instructions between the MFHI, MFLO instructions, and the MULT instruction.</p>
Multiply Unsigned	<p>MULTU rx, ry</p> <p>The contents of general-purpose registers rx and ry are multiplied, treating both operands as 32-bit unsigned values. No integer overflow exception occurs. In the 64-bit mode, the operand must be a 64-bit value formed by sign-extending a 32-bit value. The low-order 32-bit word of the result is placed in special register LO, and the high-order 32-bit word is placed in special register HI. In the 64-bit mode, each result is sign extended and stored.</p> <p>If either of the two immediately preceding instructions is MFHI or MFLO, the result of execution of these transfer instructions is undefined. To obtain the correct result, insert two or more other instructions between the MFHI, MFLO instructions and the MULTU instruction.</p>
Divide	<p>DIV rx, ry</p> <p>The contents of general-purpose register rx are divided by the contents of general-purpose register ry, treating both operands as 32-bit two's complement values. No integer overflow exception occurs. The result when the divisor is 0 is undefined. The 32-bit quotient is placed in special register LO, and the 32-bit remainder is placed in special register HI. In the 64-bit mode, the result is sign extended.</p> <p>Normally, this instruction is executed after instructions checking for division by zero and overflow. If either of the two immediately preceding instructions is MFHI or MFLO, the result of execution of these transfer instructions is undefined. To obtain the correct result, insert two or more other instructions between the MFHI, MFLO instructions and the DIV instruction.</p>
Divide Unsigned	<p>DIVU rx, ry</p> <p>The contents of general-purpose register rx are divided by the contents of general-purpose register ry, treating both operands as unsigned values. No integer overflow exception occurs. The result when the divisor is 0 is undefined. The 32-bit quotient is placed in special register LO, and the 32-bit remainder is placed in special register HI. In the 64-bit mode, the result is sign extended.</p> <p>Normally, this instruction is executed after instructions checking for division by zero. If either of the two immediately preceding instructions is MFHI or MFLO, the result of execution of these transfer instructions is undefined. To obtain the correct result, insert two or more other instructions between the MFHI, MFLO instructions and the DIVU instruction.</p>
Move From HI	<p>MFHI rx</p> <p>The contents of special register HI are loaded into general-purpose register rx.</p> <p>To ensure correct operation when an interrupt occurs, do not use an instruction that changes the HI register (MULT, MULTU, DIV, DIVU, DMULT, DMULTU, DDIV, DDIVU) for the two instructions after the MFHI instruction.</p>

Table 4-18. Multiply/Divide Instructions (2/2)

Instruction	Format and Description
Move From LO	<p>MFLO rx</p> <p>The contents of special register LO are loaded into general-purpose register rx.</p> <p>To ensure correct operation when an interrupt occurs, do not use an instruction that changes the HI register (MULT, MULTU, DIV, DIVU, DMULT, DMULTU, DDIV, DDIVU) for the two instructions after the MFLO instruction.</p>
Doubleword Multiply	<p>DMULT rx, ry</p> <p>The 64-bit contents of general-purpose register rx and ry are multiplied, treating both operands as two's complement values. No integer overflow exception occurs. The low-order 64 bits of the result are placed in special register LO, and the high-order 64 bits are placed in special register HI.</p> <p>If either of the two immediately preceding instructions is MFHI or MFLO, the result of execution of these transfer instructions is undefined. To obtain the correct result, insert two or more other instructions between the MFHI, MFLO instructions and the DMULT instruction.</p> <p>This operation is defined in the 64-bit mode and the 32-bit kernel mode. When this instruction is executed in the 32-bit user/supervisor mode, a reserved instruction exception is generated.</p>
Doubleword Multiply Unsigned	<p>DMULTU rx, ry</p> <p>The 64-bit contents of general-purpose registers rx and ry are multiplied, treating both operands as unsigned values. No integer overflow exception occurs. The low-order 64 bits of the result are placed in special register LO, and the high-order 64 bits of the result are placed in special register HI.</p> <p>If either of the two immediately preceding instructions is MFHI or MFLO, the result of execution of these transfer instructions is undefined. To obtain the correct result, insert two or more other instructions between the MFHI, MFLO instructions and the DMULTU instruction.</p> <p>This operation is defined in the 64-bit mode and the 32-bit kernel mode. When this instruction is executed in the 32-bit user/supervisor mode, a reserved instruction exception is generated.</p>
Doubleword divide	<p>DDIV rx, ry</p> <p>The 64-bit contents of general-purpose registers rx are divided by the contents of general-purpose register ry, treating both operands as two's complement values. No integer overflow exception occurs. The result when the divisor is 0 is undefined. The 64-bit quotient is placed in special register LO, and the 64-bit remainder is placed in special register HI. Normally, this instruction is executed after instructions checking for division by zero and overflow.</p> <p>If either of the two immediately preceding instructions is MFHI or MFLO, the result of execution of these transfer instructions is undefined. To obtain the correct result, insert two or more other instructions between the MFHI, MFLO instructions and the DDIV instruction.</p> <p>This operation is defined in the 64-bit mode and the 32-bit kernel mode. When this instruction is executed in the 32-bit user/supervisor mode, a reserved instruction exception is generated.</p>
Doubleword Divide Unsigned	<p>DDIVU rx, ry</p> <p>The 64-bit contents of general-purpose register rx are divided by the contents of general-purpose register ry, treating both operands as unsigned values. No integer overflow exception occurs. The result when the divisor is 0 is undefined. The 64-bit quotient is placed in special register LO, and the 64-bit remainder is placed in special register HI. Normally, this instruction is executed after an instruction checking for division by zero.</p> <p>If either of the two immediately preceding instructions is MFHI or MFLO, the result of execution of these transfer instructions is undefined. To obtain the correct result, insert two or more other instructions between the MFHI, MFLO instructions and the DDIVU instruction.</p> <p>This operation is defined in the 64-bit mode and the 32-bit kernel mode. When this instruction is executed in the 32-bit user/supervisor mode, a reserved instruction exception is generated.</p>

(3) Jump and branch instructions

Jump and Branch instructions change the control flow of a program.

All Jump instructions occur with a one-instruction delay. That is, the instruction immediately following the jump is always executed.

Branch instructions do not have a delay slot. If a branch is taken, the instruction immediately following the branch is never executed. If the branch is not taken, the instruction immediately following the branch is always executed.

Table 4-19 shows the MIPS16 Jump and Branch instructions.

Table 4-19. Jump and Branch Instructions (1/2)

Instruction	Format and Description
Jump and Link	<p>JAL target</p> <p>The 26-bit target address is shifted left two bits and combined with the high-order four bits of the address of the delay slot. The program unconditionally jumps to this calculated address with a delay of one instruction. The address of the instruction immediately following the delay slot is placed in register ra. The ISA Mode bit is left unchanged. The value stored in ra bit 0 will reflect the current ISA Mode bit.</p>
Jump and Link Exchange	<p>JALX target</p> <p>The 26-bit target address is shifted left two bits and combined with the high-order four bits of the address of the delay slot. The program unconditionally jumps to this calculated address with a delay of one instruction. The address of the instruction immediately following the delay slot is placed in register ra. The ISA Mode bit is inverted with a delay of one instruction. The value stored in ra bit 0 will reflect the ISA Mode bit before execution of the Jump execution.</p>
Jump Register	<p>JR rx</p> <p>The program unconditionally jumps to the address specified in general-purpose register rx, with a delay of one instruction. The instruction sets the ISA Mode bit to the value in rx bit 0. If the Jump target address is in the MIPS16 instruction length mode, no address exception occurs when bit 0 of the source register is 1 because bit 0 of the target address is 0 so that the instruction is located at the halfword boundary.</p> <p>If the 32-bit length instruction mode is changed, an address exception occurs when the jump target address is fetched if the two low-order bits of the target address are not 0.</p>
	<p>JR ra</p> <p>The program unconditionally jumps to the address specified in register ra, with a delay of one instruction. The instruction sets the ISA Mode bit to the value in ra bit 0. If the Jump target address is in the MIPS16 instruction length mode, no address exception occurs when bit 0 of the source register is 1 because bit 0 of the target address is 0 so that the instruction is located at the halfword boundary.</p> <p>If the 32-bit length instruction mode is changed, an address exception occurs when the jump target address is fetched if the two low-order bits of the target address are not 0.</p>
Jump and Link Register	<p>JALR ra, rx</p> <p>The program unconditionally jumps to the address contained in register rx, with a delay of one instruction. This instruction sets the ISA Mode bit to the value in rx bit 0. The address of the instruction immediately following the delay slot is placed in register ra. The value stored in ra bit 0 will reflect the ISA mode bit before the jump execution is executed.</p> <p>If the Jump target address is in the MIPS16 instruction length mode, no address exception occurs when bit 0 of the source register is 1 because bit 0 of the target address is 0 so that the instruction is located at the halfword boundary.</p> <p>If the 32-bit length instruction mode is changed, an address exception occurs when the jump target address is fetched if the two low-order bits of the target address are not 0.</p>

Table 4-19. Jump and Branch Instructions (2/2)

Instruction	Format and Description
Branch on Equal to Zero	BEQZ rx, immediate The 8-bit immediate is shifted left one bit, sign extended, and then added to the address of the instruction after the branch to form the target address. If the contents of general-purpose register rx are equal to zero, the program branches to the target address. No delay slot is generated.
Branch on Not Equal to Zero	BNEZ rx, immediate The 8-bit immediate is shifted left one bit, sign extended, and then added to the address of the instruction after the branch to form the target address. If the contents of general-purpose register rx are not equal to zero, the program branches to the target address. No delay slot is generated.
Branch on T Equal to Zero	BTEQZ immediate The 8-bit immediate is shifted left one bit, sign extended, and then added to the address of the instruction after the branch to form the target address. If the contents of special register T (\$24) are not equal to zero, the program branches to the target address. No delay slot is generated.
Branch on T Not Equal to Zero	BTNEZ immediate The 8-bit immediate is shifted left one bit, sign extended, and then added to the address of the instruction after the branch to form the target address. If the contents of special register T (\$24) are not equal to zero, the program branches to the target address. No delay slot is generated.
Branch Unconditional	B immediate The 11-bit immediate is shifted left one bit, sign extended, and then added to the address of the instruction after the branch to form the target address. The program branches to the target address unconditionally.

(4) Special instructions

Special instructions unconditionally perform branching to general exception vectors. Special instructions are of the R type. Table 4-20 shows two special instructions.

Table 4-20. Special Instructions

Instruction	Format and Description
Breakpoint	BREAK immediate A breakpoint trap occurs, immediately and unconditionally transferring control to the exception handler. By using a 6-bit code area, parameters can be sent to the exception handler. If the exception handler uses this parameter, the contents of memory including instructions must be loaded as data.
Extend	EXTEND immediate The 11-bit immediate is combined with the immediate in the next instruction to form a larger immediate equivalent to 32-bit MIPS. The Extend instruction must always precede (by one instruction) the instruction whose immediate field you want to extend. Every extended instruction consumes four bytes in program memory instead of two bytes (two bytes for Extend and two bytes for the instruction being extended), and it can cross a word boundary. (For details, see 4.8.2 Extend instruction .)

CHAPTER 5 VR4181 PIPELINE

This chapter describes the basic operation of the VR4181 processor pipeline, which includes descriptions of the delay slots (instructions that follow a branch or load instruction in the pipeline), interrupts to the pipeline flow caused by interlocks and exceptions, and CP0 hazards.

5.1 Pipeline Stages

The VR4181 has a five-stage instruction pipeline; each stage takes one PCycle (one cycle of Pclock), and each PCycle has two phases: $\Phi 1$ and $\Phi 2$, as shown in Figure 5-1. Thus, the execution of each instruction takes at least 5 PCycles. An instruction can take longer - for example, if the required data is not in the cache, the data must be retrieved from main memory. Once the pipeline has been filled, five instructions are executed simultaneously.

Figure 5-1. Pipeline Stages

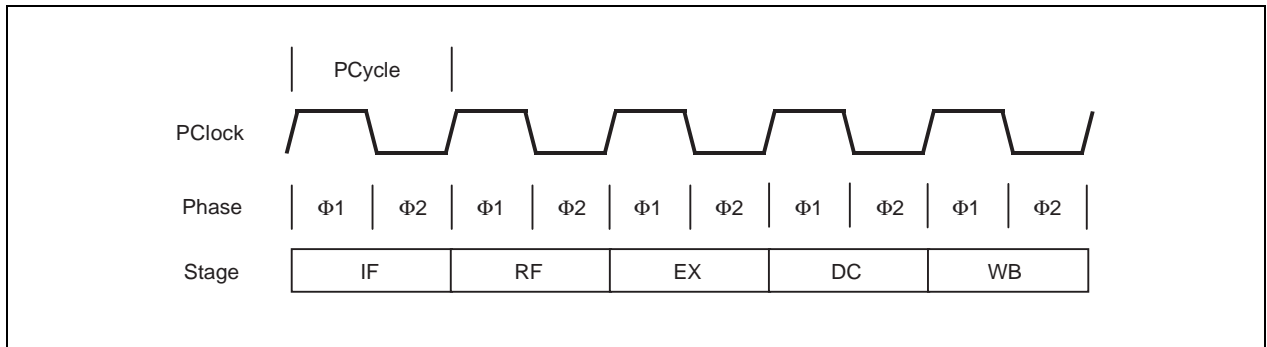

The five pipeline stages are:

- IF - Instruction cache fetch
- RF - Register fetch
- EX - Execution
- DC - Data cache fetch
- WB - Write back

Figure 5-2 shows the five stages of the instruction pipeline. In this figure, a row indicates the execution process of each instruction, and a column indicates the processes executed simultaneously.

Figure 5-2. Instruction Execution in the Pipeline

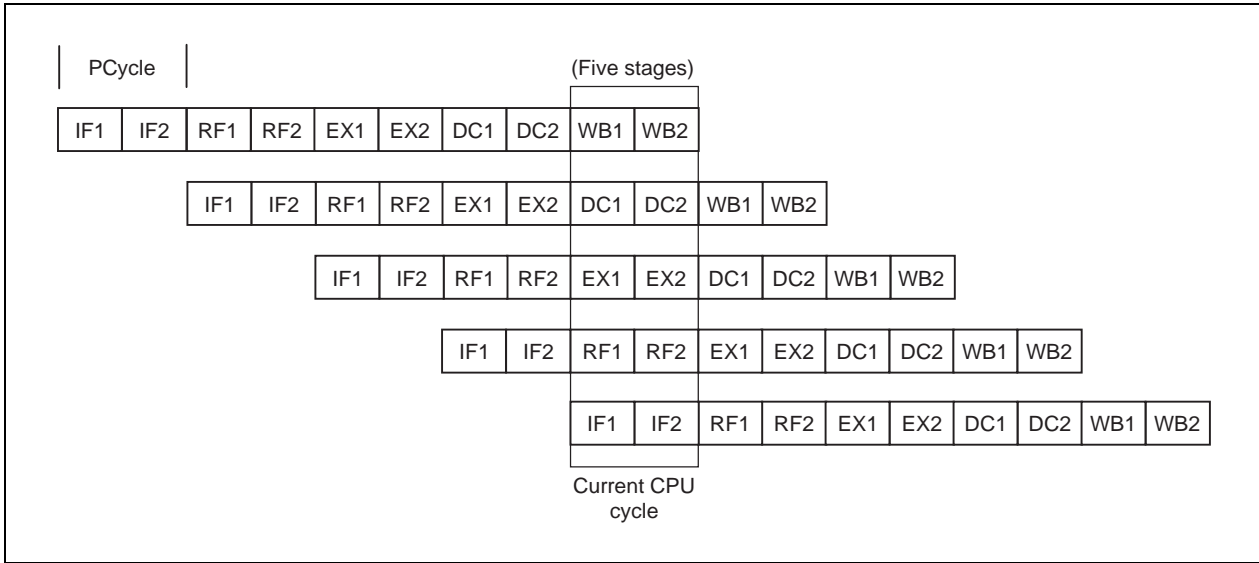

5.1.1 Pipeline activities

Figure 5-3 shows the activities that can occur during each pipeline stage; Table 5-1 describes these pipeline activities.

Figure 5-3. Pipeline Activities

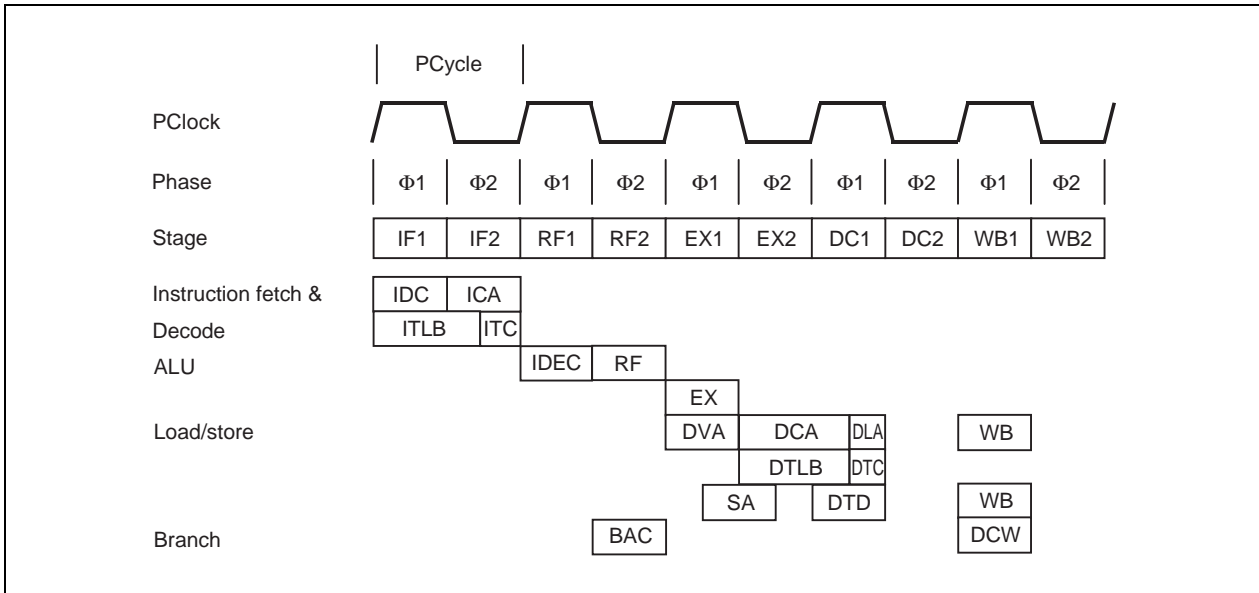

Table 5-1. Description of Pipeline Activities during Each Stage

Cycle	Phase	Mnemonic	Description
IF	Φ1	IDC	Instruction cache address decode
		ITLB	Instruction address translation
	Φ2	ICA	Instruction cache array access
		ITC	Instruction tag check
RF	Φ1	IDEC	Instruction decode
	Φ2	RF	Register operand fetch
		BAC	Branch address calculation
EX	Φ1	EX	Execution stage
		DVA	Data virtual address calculation
		SA	Store align
	Φ2	DCA	Data cache address decode/array access
		DTLB	Data address translation
DC	Φ1	DLA	Data cache load align
		DTC	Data tag check
		DTD	Data transfer to data cache
WB	Φ1	DCW	Data cache write
		WB	Write back to register file

5.2 Branch Delay

During a Vr4181's pipeline operation, a one-cycle branch delay occurs when:

- Target address is calculated by a Jump instruction
- Branch condition of branch instruction is met and then logical operation starts for branch-destination comparison

The instruction address generated at the EX stage in the Jump/Branch instruction are available in the IF stage, two instructions later. No branch delay slot due to a branch instruction occurs in MIPS16 ISA. When a branch condition is met, the instruction representing a delay slot is discarded.

Figure 5-4 illustrates the branch delay and the location of the branch delay slot.

Figure 5-4. Branch Delay

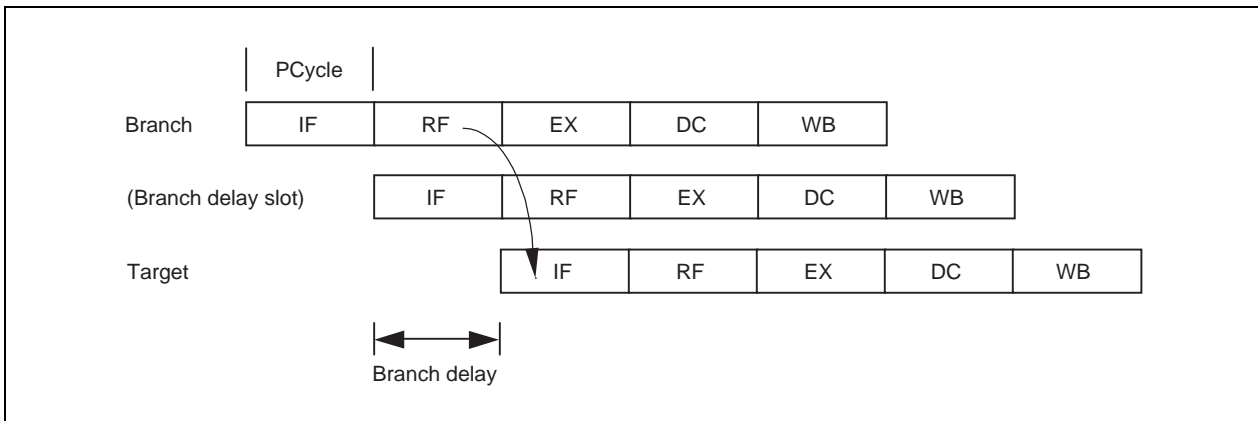

5.3 Load Delay

A load instruction that does not allow its result to be used by the instruction immediately following is called a delayed load instruction. The instruction immediately following this delayed load instruction is referred to as the load delay slot.

In the VR4181, the instruction immediately following a load instruction can use the contents of the loaded register, however in such cases hardware interlocks insert additional delay cycles. Consequently, scheduling load delay slots can be desirable, both for performance and VR-Series processor compatibility.

5.4 Pipeline Operation

The operation of the pipeline is illustrated by the following examples that describe how typical instructions are executed. The instructions described are: ADD, JALR, BEQ, TLT, LW, and SW. Each instruction is taken through the pipeline and the operations that occur in each relevant stage are described.

(1) Add instruction (ADD rd, rs, rt)

- IF stage In $\Phi 1$ of the IF stage, the eleven least-significant bits of the virtual address are used to access the instruction cache. In $\Phi 2$ of the IF stage, the cache index is compared with the page frame number and the cache data is read out. The virtual PC is incremented by 4 so that the next instruction can be fetched.

- RF stage During $\Phi 2$, the 2-port register file is addressed with the rs and rt fields and the register data is valid at the register file output. At the same time, bypass multiplexers select inputs from either the EX- or DC-stage output in addition to the register file output, depending on the need for an operand bypass.

- EX stage The ALU controls are set to do an A + B operation. The operands flow into the ALU inputs, and the ALU operation is started. The result of the ALU operation is latched into the ALU output latch during $\Phi 1$.

- DC stage This stage is a NOP for this instruction. The data from the output of the EX stage (the ALU) is moved into the output latch of the DC.

- WB stage During $\Phi 1$, the WB latch feeds the data to the inputs of the register file, which is accessed by the rd field. The file write strobe is enabled. By the end of $\Phi 1$, the data is written into the file.

Figure 5-5. Add Instruction Pipeline Activities

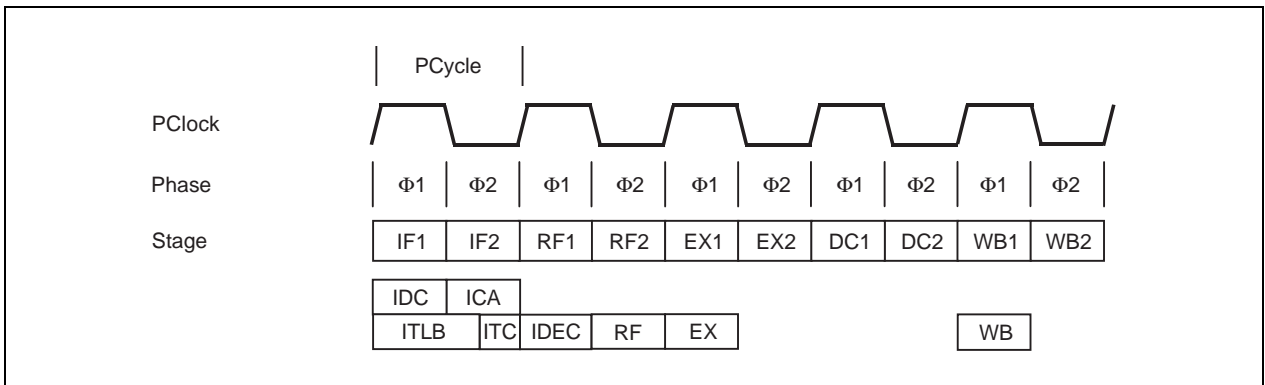

(2) Jump and Link Register instruction (JALR rd, rs)

- IF stage Same as the IF stage for the ADD instruction.
- RF stage A register specified in the rs field is read from the file during $\Phi 2$ at the RF stage, and the value read from the rs register is input to the virtual PC latch synchronously. This value is used to fetch an instruction at the jump destination. The value of the virtual PC incremented during the IF stage is incremented again to produce the link address $PC + 8$ where PC is the address of the JALR instruction. The resulting value is the PC to which the program will eventually return. This value is placed in the Link output latch of the Instruction Address unit.
- EX stage The $PC + 8$ value is moved from the Link output latch to the output latch of the EX stage.
- DC stage The $PC + 8$ value is moved from the output latch of the EX stage to the output latch of the DC stage.
- WB stage Refer to the ADD instruction. Note that if no value is explicitly provided for rd then register 31 is used as the default. If rd is explicitly specified, it cannot be the same register addressed by rs; if it is, the result of executing such an instruction is undefined.

Figure 5-6. JALR Instruction Pipeline Activities

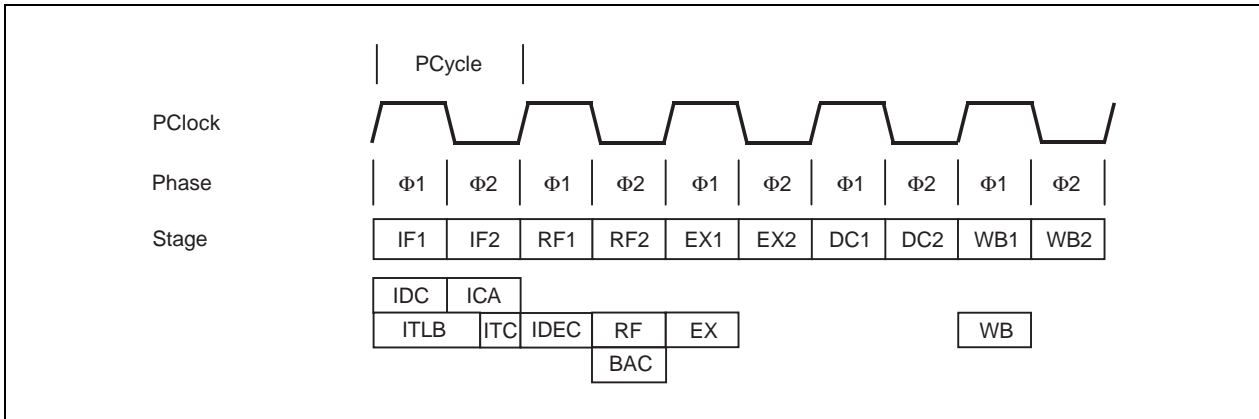

(3) Branch on Equal instruction (BEQ rs, rt, offset)

- IF stage Same as the IF stage for the ADD instruction.

- RF stage During $\Phi 2$, the register file is addressed with the rs and rt fields. A check is performed to determine if each corresponding bit position of these two operands has equal values. If they are equal, the PC is set to PC + target, where target is the sign-extended offset field. If they are not equal, the PC is set to PC + 4.

- EX stage The next PC resulting from the branch comparison is valid at the beginning of $\Phi 2$ for instruction fetch.

- DC stage This stage is a NOP for this instruction.

- WB stage This stage is a NOP for this instruction.

Figure 5-7. BEQ Instruction Pipeline Activities

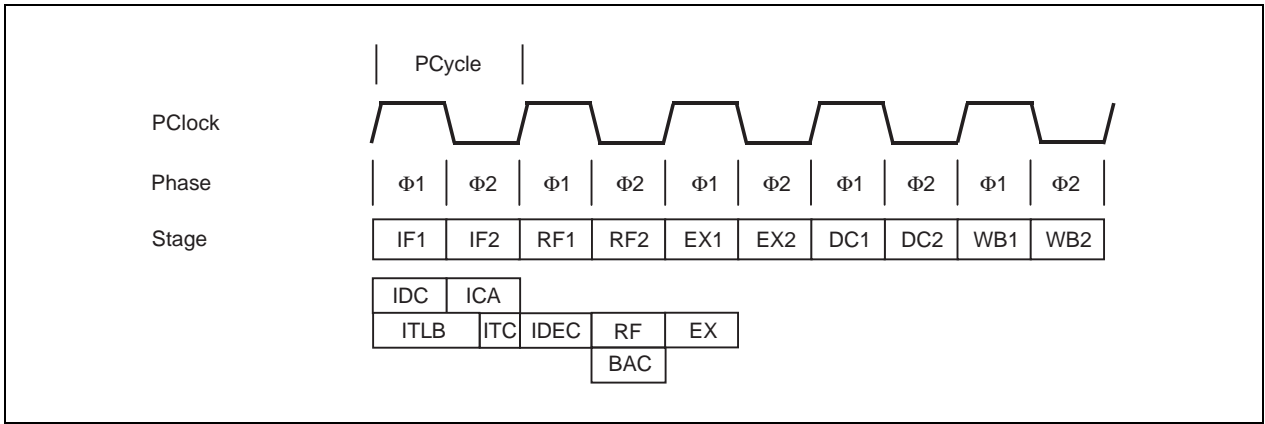

(4) Trap if Less Than instruction (TLT rs, rt)

IF stage	Same as the IF stage for the ADD instruction.
RF stage	Same as the RF stage for the ADD instruction.
EX stage	ALU controls are set to do an A – B operation. The operands flow into the ALU inputs, and the ALU operation is started. The result of the ALU operation is latched into the ALU output latch during $\Phi 1$. The sign bits of operands and of the ALU output latch are checked to determine if a less than condition is true. If this condition is true, a Trap exception occurs. The value in the PC register is used as an exception vector value, and from now on any instruction will be invalid.
DC stage	No operation
WB stage	The EPC register is loaded with the value of the PC if the less than condition was met in the EX stage. The Cause register ExCode field and BD bit are updated appropriately, as is the EXL bit of the Status register. If the less than condition was not met in the EX stage, no activity occurs in the WB stage.

Figure 5-8. TLT Instruction Pipeline Activities

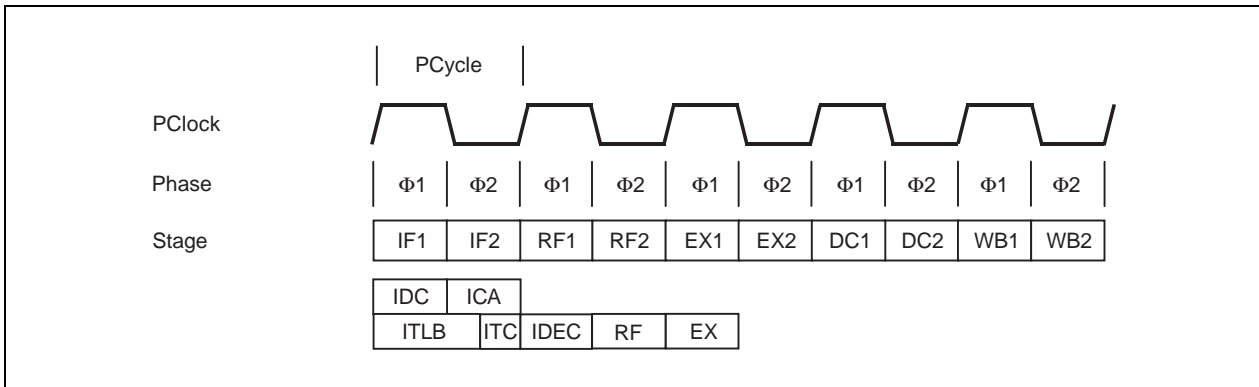

(5) Load Word instruction (LW rt, offset (base))

- IF stage Same as the IF stage for the ADD instruction.
- RF stage Same as the RF stage for the ADD instruction. Note that the base field is in the same position as the rs field.
- EX stage Refer to the EX stage for the ADD instruction. For LW, the inputs to the ALU come from GPR[base] through the bypass multiplexer and from the sign-extended offset field. The result of the ALU operation that is latched into the ALU output latch in $\Phi 1$ represents the effective virtual address of the operand (DVA).
- DC stage The cache tag field is compared with the Page Frame Number (PFN) field of the TLB entry. After passing through the load aligner, aligned data is placed in the DC output latch during $\Phi 2$.
- WB stage During $\Phi 1$, the cache read data is written into the register file addressed by the rt field.

Figure 5-9. LW Instruction Pipeline Activities

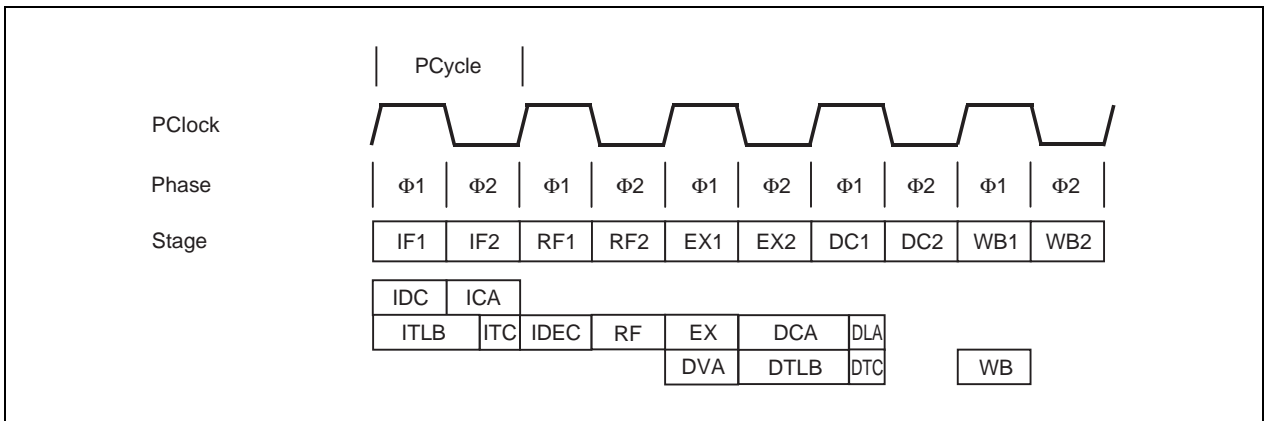

(6) Store Word instruction (SW rt, offset (base))

- IF stage Same as the IF stage for the ADD instruction.

- RF stage Same as the RF stage for the LW instruction.

- EX stage Refer to the LW instruction for a calculation of the effective address. From the RF output latch, the GPR[rt] is sent through the bypass multiplexer and into the main shifter, where the shifter performs the byte-alignment operation for the operand. The results of the ALU are latched in the output latches during $\Phi 1$. The shift operations are latched in the output latches during $\Phi 2$.

- DC stage Refer to the LW instruction for a description of the cache access.

- WB stage If there was a cache hit, the content of the store data output latch is written into the data cache at the appropriate word location.
 Note that all store instructions use the data cache for two consecutive PCycles. If the following instruction requires use of the data cache, the pipeline is slipped for one PCycle to complete the writing of an aligned store data.

Figure 5-10. SW Instruction Pipeline Activities

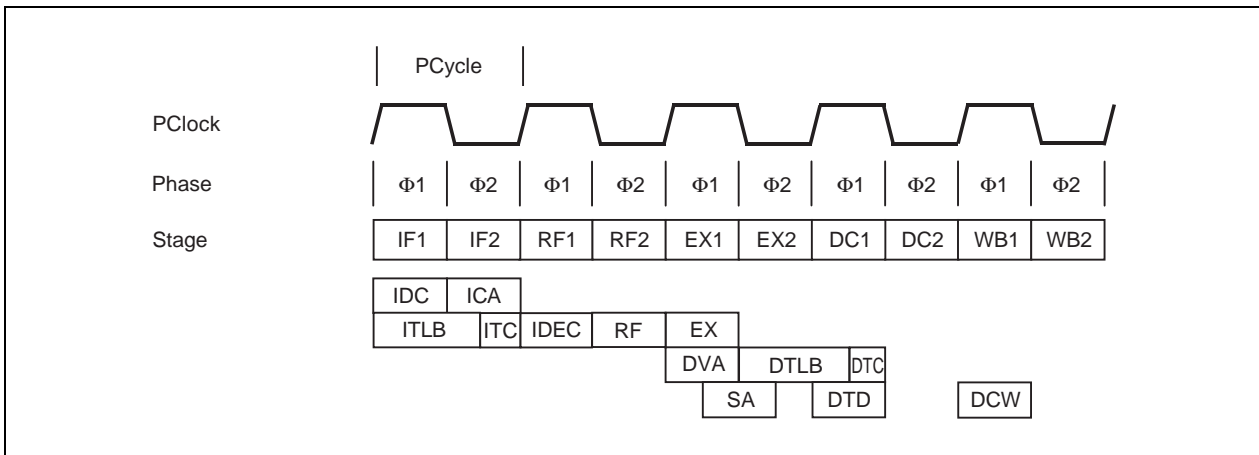

5.5 Interlock and Exception Handling

Smooth pipeline flow is interrupted when cache misses or exceptions occur, or when data dependencies are detected. Interruptions handled using hardware, such as cache misses, are referred to as interlocks, while those that are handled using software are called exceptions. As shown in Figure 5-11, all interlock and exception conditions are collectively referred to as faults.

Figure 5-11. Interlocks, Exceptions, and Faults

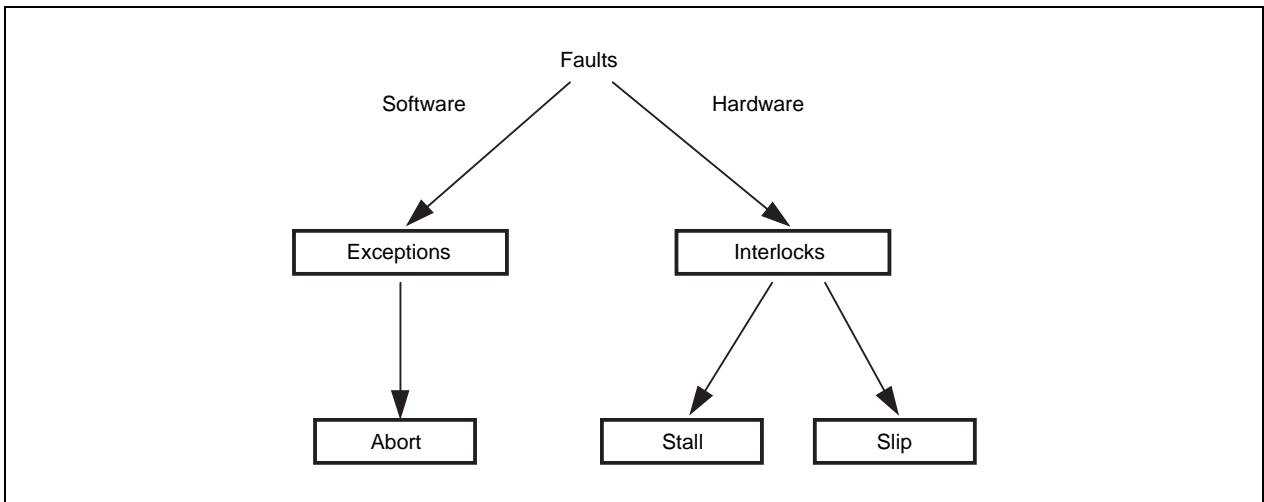

At each cycle, exception and interlock conditions are checked for all active instructions.

Because each exception or interlock condition corresponds to a particular pipeline stage, a condition can be traced back to the particular instruction in the exception/interlock stage, as shown in Table 5-2. For instance, an LDI Interlock is raised in the Register Fetch (RF) stage.

Tables 5-2 to 5-4 describe the pipeline interlocks and exceptions listed in Table 5-2.

Table 5-2. Correspondence of Pipeline Stage to Interlock and Exception Conditions

Status \ Stage		IF	RF	EX	DC	WB
Interlock	Stall	–	ITM ICM	–	DTM DCM DCB	–
	Slip	–	LDI MDI SLI CPO	–	–	–
Exception		IAErr	NMI ITLB IPErr INTr IBE SYSC BP Cun RSVD	Trap OVF DAErr	Reset DTLB Tmod DPErr WAT DBE	–

Remark In the above table, exception conditions are listed up in higher priority order.

Table 5-3. Pipeline Interlock

Interlock	Description
ITM	Interrupt TLB Miss
ICM	Interrupt Cache Miss
LDI	Load Data Interlock
MDI	MD Busy Interlock
SLI	Store-Load Interlock
CP0	Coprocessor 0 Interlock
DTM	Data TLB Miss
DCM	Data Cache Miss
DCB	Data Cache Busy

Table 5-4. Description of Pipeline Exception

Exception	Description
IAErr	Instruction Address Error exception
NMI	Non-maskable Interrupt exception
ITLB	ITLB exception
IPErr	Instruction Parity Error exception
INTR	Interrupt exception
IBE	Instruction Bus Error exception
SYSC	System Call exception
BP	Breakpoint exception
CUn	Coprocessor Unusable exception
RSVD	Reserved Instruction exception
Trap	Trap exception
OVF	Overflow exception
DAErr	Data Address Error exception
Reset	Reset exception
DTLB	DTLB exception
DTMod	DTLB Modified exception
WAT	Watch exception
DBE	Data Bus Error exception

5.5.1 Exception conditions

When an exception condition occurs, the relevant instruction and all those that follow it in the pipeline are cancelled. Accordingly, any stall conditions and any later exception conditions that may have referenced this instruction are inhibited; there is no benefit in servicing stalls for a cancelled instruction.

When an exceptional conditions is detected for an instruction, the VR4181 will kill it and all following instructions. When this instruction reaches the WB stage, the exception flag and various information items are written to CP0 registers. The current PC is changed to the appropriate exception vector address and the exception bits of earlier pipeline stages are cleared.

This implementation allows all preceding instructions to complete execution and prevents all subsequent instructions from completing. Thus the value in the EPC is sufficient to restart execution. It also ensures that exceptions are taken in the order of execution; an instruction taking an exception may itself be killed by an instruction further down the pipeline that takes an exception in a later cycle.

Figure 5-12. Exception Detection

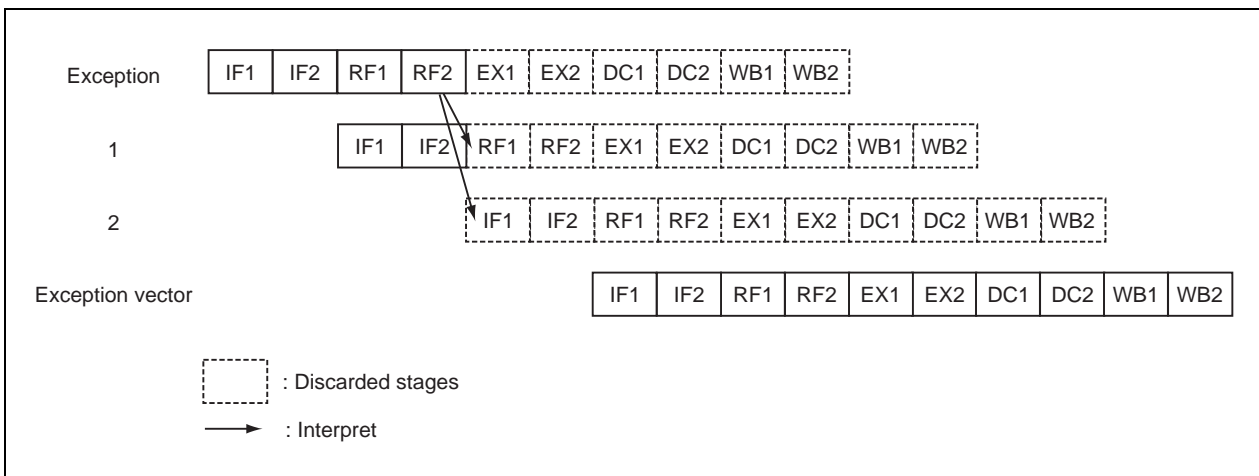

5.5.2 Stall conditions

Stalls are used to stop the pipeline for conditions detected after the RF stage. When a stall occurs, the processor will resolve the condition and then the pipeline will continue. Figure 5-13 shows a data cache miss stall, and Figure 5-14 shows a CACHE instruction stall.

Figure 5-13. Data Cache Miss Stall

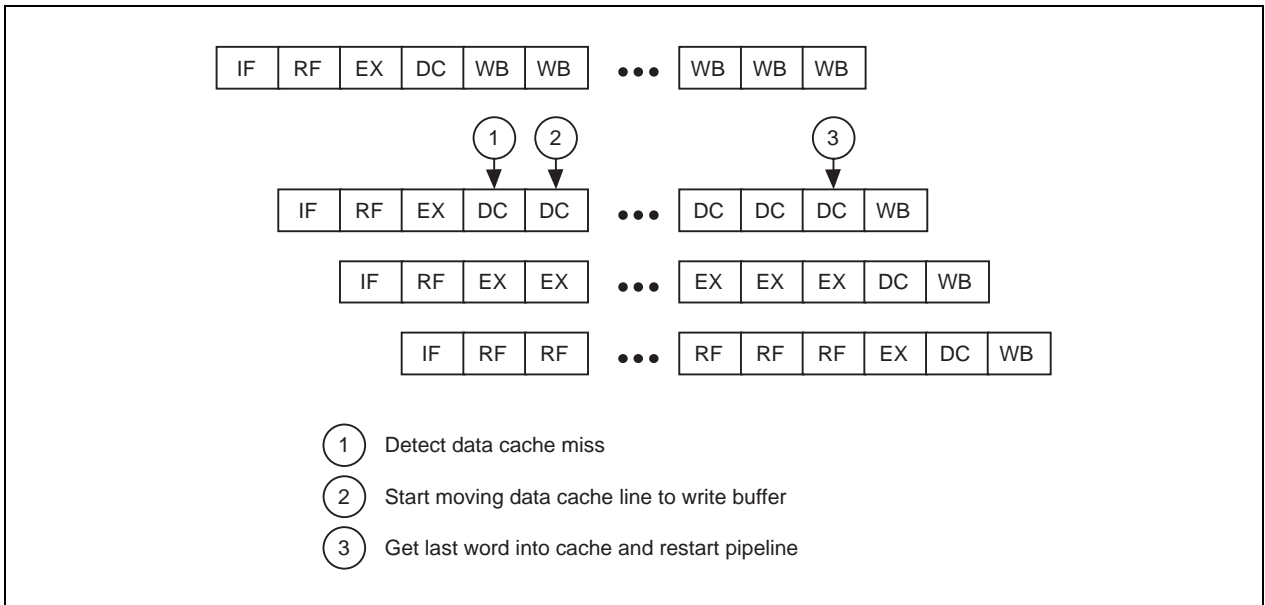

If the cache line to be replaced is dirty — the W bit is set — the data is moved to the internal write buffer in the next cycle. The write-back data is returned to memory. The last word in the data is returned to the cache at 3, and pipelining restarts.

Figure 5-14. CACHE Instruction Stall

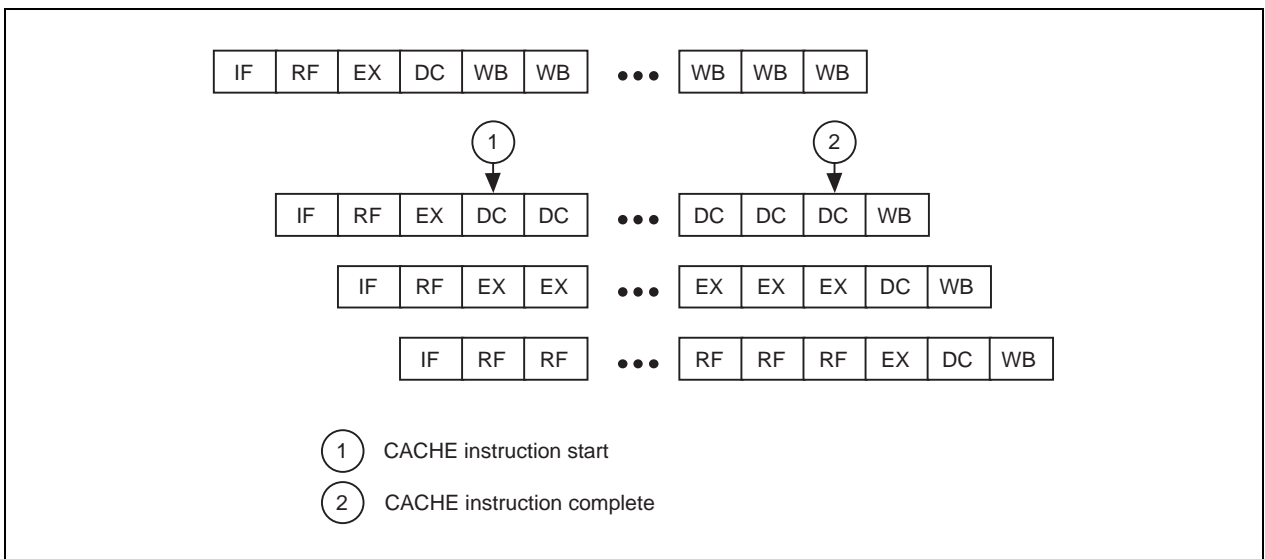

When the CACHE instruction enters the DC pipe-stage, the pipeline stalls while the CACHE instruction is executed. The pipeline begins running again when the CACHE instruction is completed, allowing the instruction fetch to proceed.

5.5.3 Slip conditions

During $\Phi 2$ of the RF stage and $\Phi 1$ of the EX stage, internal logic will determine whether it is possible to start the current instruction in this cycle. If all of the source operands are available (either from the register file or via the internal bypass logic) and all the hardware resources necessary to complete the instruction will be available whenever required, then the instruction “run”; otherwise, the instruction will “slip”. Slipped instructions are retired on subsequent cycles until they issue. The backend of the pipeline (stages DC and WB) will advance normally during slips in an attempt to resolve the conflict. NOPs will be inserted into the bubble in the pipeline. Instructions killed by branch likely instructions, ERET or exceptions will not cause slips.

Figure 5-15. Load Data Interlock

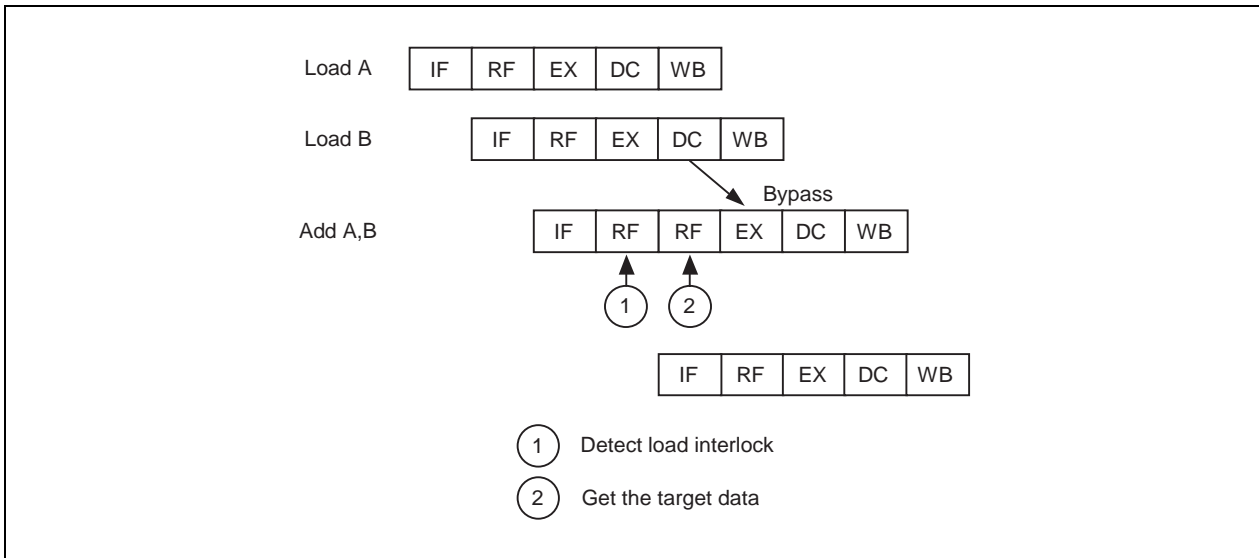

Load Data Interlock is detected in the RF stage shown in as Figure 5-15 and also the pipeline slips in the stage. Load Data Interlock occurs when data fetched by a load instruction and data moved from HI, LO or CP0 register is required by the next immediate instruction. The pipeline begins running again when the clock after the target of the load is read from the data cache, HI, LO and CP0 registers. The data returned at the end of the DC stage is input into the end of the RF stage, using the bypass multiplexers.

Figure 5-16. MD Busy Interlock

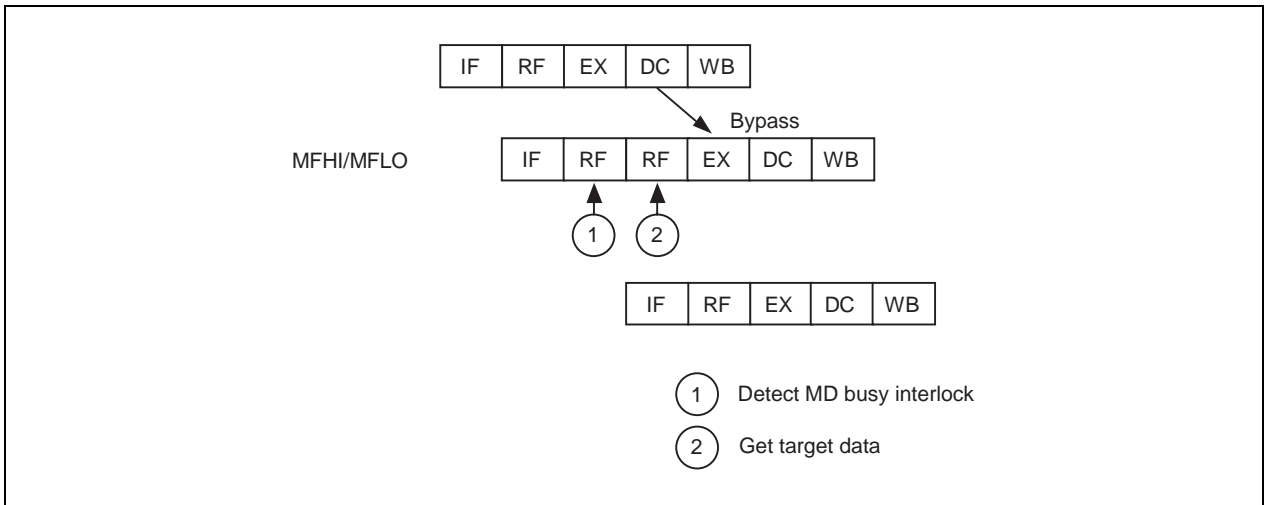

MD Busy Interlock is detected in the RF stage as shown in Figure 5-16 and also the pipeline slips in the stage. MD Busy Interlock occurs when Hi/Lo register is required by MFHi/Lo instruction before finishing Mult/Div execution. The pipeline begins running again the clock after finishing Mult/Div execution. The data returned from the Hi/Lo register at the end of the DC stage is input into the end of the RF stage, using the bypass multiplexers.

Store-Load Interlock is detected in the EX stage and the pipeline slips in the RF stage. Store-Load Interlock occurs when store instruction followed by load instruction is detected. The pipeline begins running again one clock after.

Coprocessor 0 Interlock is detected in the EX stage and the pipeline slips in the RF stage. A coprocessor interlock occurs when an MTC0 instruction for the Configuration or Status register is detected.

The pipeline begins running again one clock after.

5.5.4 Bypassing

In some cases, data and conditions produced in the EX, DC and WB stages of the pipeline are made available to the EX stage (only) through the bypass data path.

Operand bypass allows an instruction in the EX stage to continue without having to wait for data or conditions to be written to the register file at the end of the WB stage. Instead, the Bypass Control Unit is responsible for ensuring data and conditions from later pipeline stages are available at the appropriate time for instructions earlier in the pipeline.

The Bypass Control Unit is also responsible for controlling the source and destination register addresses supplied to the register file.

5.6 Code Compatibility

The VR4110 CPU core can execute all programs that can be executed in other VR-Series processors. But the reverse is not necessarily true. Programs compiled using a standard MIPS compiler can be executed in both types of processors. When using manual assembly, however, write programs carefully so that compatibility with other VR-series processors can be maintained. Matters which should be paid attention to when porting programs between the VR4110 CPU core and other VR-Series processors are listed below.

- The VR4110 CPU core does not support floating-point instructions since it has no Floating-Point Unit (FPU).
- Multiply-add instructions (DMADD16, MADD16) are added in the VR4110 CPU core.
- Instructions for power modes (HIBERNATE, STANDBY, SUSPEND) are added in the VR4110 CPU core to support power modes.
- The VR4110 CPU core does not have the LL bit to perform synchronization of multiprocessing. Therefore, the CPU core does not support instructions which manipulate the LL bit (LL, LLD, SC, SCD).
- A 16-bit length MIPS16 instruction set is added in the VR4110 CPU core.
- The CP0 hazards of the VR4110 CPU core are equally or less stringent than those of other processors (see Chapter 29 for details).

For more information, refer to Chapters 3, 4, 27, and 28, **VR4100 User's Manual**, or **VR4300™**, **VR4305™**, **VR4310™ User's Manual**.

CHAPTER 6 MEMORY MANAGEMENT SYSTEM

The V_R4181 provides a memory management unit (MMU) which uses a translation lookaside buffer (TLB) to translate virtual addresses into physical addresses. This chapter describes the virtual and physical address spaces, the virtual-to-physical address translation, the operation of the TLB in making these translations, and the CP0 registers that provide the software interface to the TLB.

6.1 Translation Lookaside Buffer (TLB)

Virtual addresses are translated into physical addresses using an on-chip TLB. The on-chip TLB is a fully-associative memory that holds 32 entries, which provide mapping to 32 odd/even page pairs for one entry. The pages can have five different sizes, 1 K, 4 K, 16 K, 64 K, and 256 K, and can be specified in each entry. If it is supplied with a virtual address, each of the 32 TLB entries is checked simultaneously to see whether they match the virtual addresses that are provided with the ASID field and saved in the EntryHi register.

If there is a virtual address match, or “hit,” in the TLB, the physical page number is extracted from the TLB and concatenated with the offset to form the physical address.

If no match occurs (TLB “miss”), an exception is taken and software refills the TLB from the page table resident in memory. The software writes to an entry selected using the Index register or a random entry indicated in the Random register.

If more than one entry in the TLB matches the virtual address being translated, the operation is undefined and the TLB may be disabled. In this case, the TLB-Shutdown (TS) bit of the Status register is set to 1, and the TLB becomes unusable (an attempt to access the TLB results in a TLB Mismatch exception regardless of whether there is an entry that hits). The TS bit can be cleared only by a reset.

Note that virtual addresses may be converted to physical addresses without using a TLB, depending on the address space that is being subjected to address translation. For example, address translation for the kseg0 or kseg1 address space does not use mapping. The physical addresses of these address spaces are determined by subtracting the base address of the address space from the virtual addresses.

6.2 Virtual Address Space

The address space of the CPU is extended in memory management system, by converting (translating) huge virtual memory addresses into physical addresses.

The physical address space of the V_R4181 is 4 Gbytes and 32-bit width addresses are used.

For the virtual address space, up to 2 Gbytes (2^{31}) are provided as a user's area and 32-bit width addresses are used in the 32-bit mode. In the 64-bit mode, up to 1 Tbyte (2^{40}) is provided as a user's area and 64-bit width addresses are used. For the format of the TLB entry in each mode, refer to **6.4.1**.

As shown in Figures 6-2 and 6-3, the virtual address is extended with an address space identifier (ASID), which reduces the frequency of TLB flushing when switching contexts. This 8-bit ASID is in the CP0 EntryHi register, and the Global (G) bit is in the EntryLo0 and EntryLo1 registers, described later in this chapter.

Figure 6-1. Virtual-to-Physical Address Translation

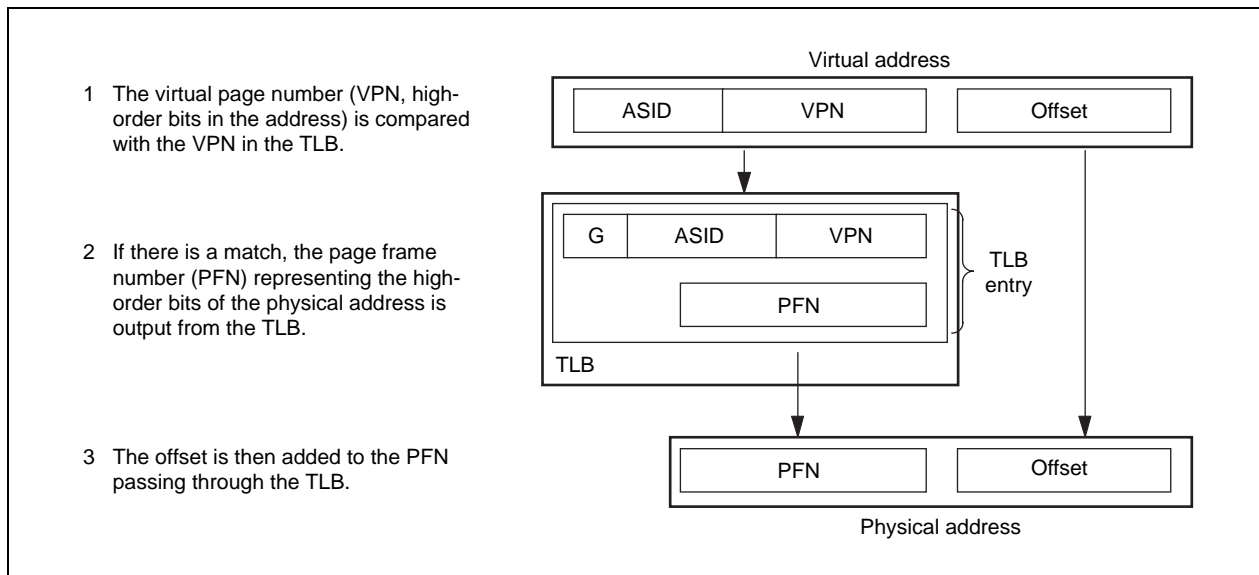

6.2.1 Virtual-to-physical address translation

Converting a virtual address to a physical address begins by comparing the virtual address from the processor with the virtual addresses of all entries in the TLB; there is a match when the virtual page number (VPN) of the address is the same as the VPN field of the entry, and either:

- the Global (G) bit of the TLB entry is set to 1, or
- the ASID field of the virtual address is the same as the ASID field of the TLB entry.

This match is referred to as a TLB hit. If there is no match, a TLB Mismatch exception is taken by the processor and software is allowed to refill the TLB from a page table of virtual/physical addresses in memory.

If there is a virtual address match in the TLB, the physical address is output from the TLB and concatenated with the offset, which represents an address within the page frame space. The offset does not pass through the TLB. Instead, the low-order bits of the virtual address are output without being translated. See descriptions about the virtual address space for details. For details about the physical address, see **6.5.11 Virtual-to-physical address translation**.

The next two sections describe the 32-bit and 64-bit mode address translations.

6.2.2 32-bit mode address translation

Figure 6-2 shows the virtual-to-physical-address translation of a 32-bit mode address. The pages can have five different sizes between 1 Kbyte (10 bits) and 256 Kbytes (18 bits), each being 4 times as large as the preceding one in ascending order, that is 1 K, 4 K, 16 K, 64 K, and 256 K. This figure illustrates the two possible page sizes: a 1-Kbyte page (10 bits) and a 256-Kbyte page (18 bits).

- Shown at the top of Figure 6-2 is the virtual address space in which the page size is 1 Kbyte and the offset is 10 bits. The 22 bits excluding the ASID field represents the virtual page number (VPN), enabling selecting a page table of 4 M entries.
- Shown at the bottom of Figure 6-2 is the virtual address space in which the page size is 256 Kbytes and the offset is 18 bits. The 14 bits excluding the ASID field represents the VPN, enabling selecting a page table of 16 K entries.

Figure 6-2. 32-bit Mode Virtual Address Translation

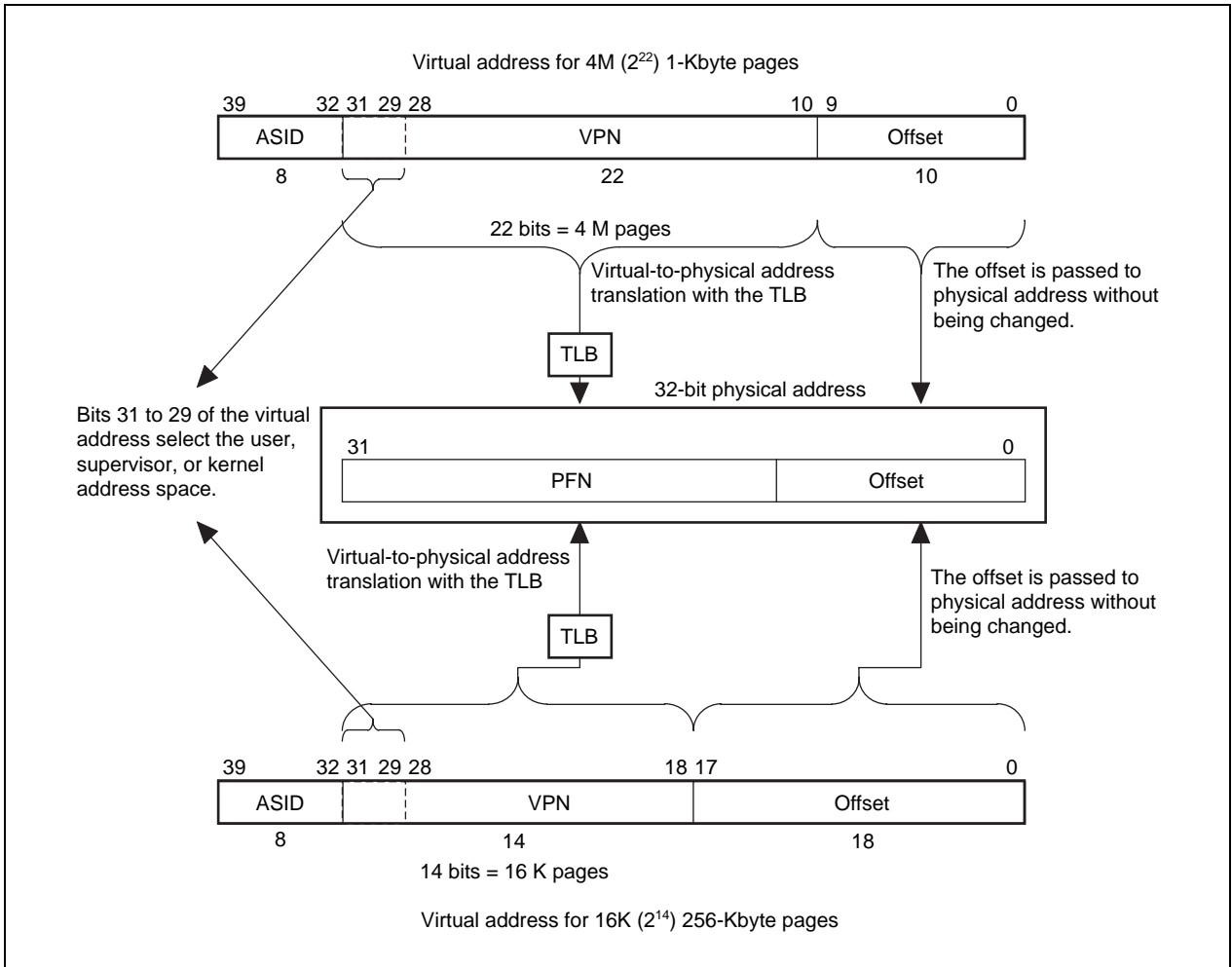

6.2.3 64-bit mode address translation

Figure 6-3 shows the virtual-to-physical-address translation of a 64-bit mode address. The pages can have five different sizes between 1 Kbyte (10 bits) and 256 Kbytes (18 bits), each being 4 times as large as the preceding one in ascending order, that is 1 K, 4 K, 16 K, 64 K, and 256 K. This figure illustrates the two possible page sizes: a 1-Kbyte page (10 bits) and a 256-Kbyte page (18 bits).

- Shown at the top of Figure 6-3 is the virtual address space in which the page size is 1 Kbyte and the offset is 10 bits. The 30 bits excluding the ASID field represents the virtual page number (VPN), enabling selecting a page table of 1 G entry.
- Shown at the bottom of Figure 6-3 is the virtual address space in which the page size is 256 Kbytes and the offset is 18 bits. The 22 bits excluding the ASID field represents the VPN, enabling selecting a page table of 4 M entries.

Figure 6-3. 64-bit Mode Virtual Address Translation

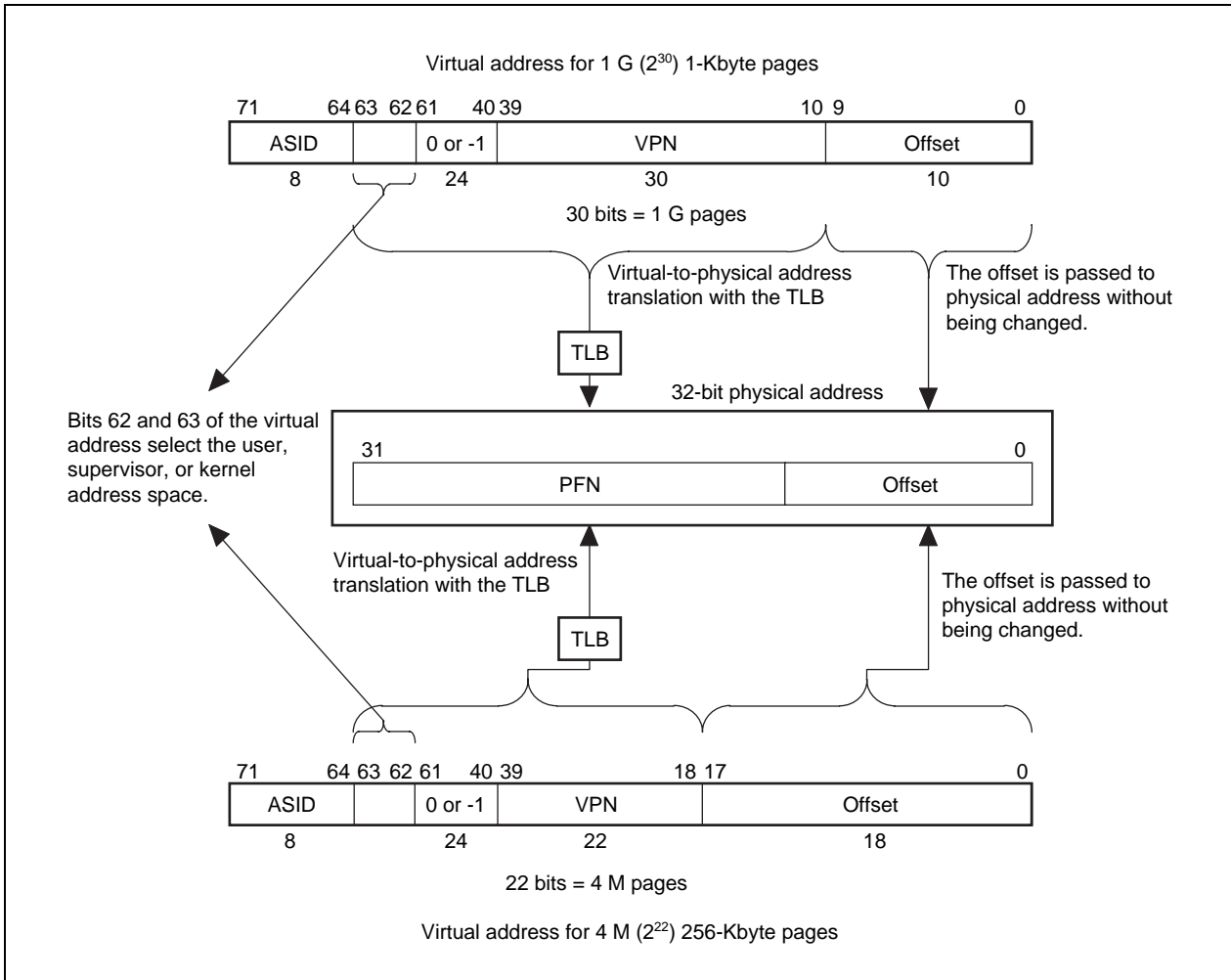

6.2.4 Operating modes

The processor has three operating modes that function in both 32- and 64-bit operations:

- User mode
- Supervisor mode
- Kernel mode

User and Kernel modes are common to all Vr-Series processors. Generally, Kernel mode is used to executing the operating system, while User mode is used to run application programs. The Vr4000 series processors have a third mode, which is called Supervisor mode and categorized in between User and Kernel modes. This mode is used to configure a high-security system.

When an exception occurs, the CPU enters Kernel mode, and remains in this mode until an exception return instruction (ERET) is executed. The ERET instruction brings back the processor to the mode in which it was just before the exception occurs.

These modes are described in the next three sections.

6.2.5 User mode virtual addressing

During User mode, a 2-Gbyte (2^{31} bytes) virtual address space (useg) can be used in the 32-bit mode. In the 64-bit mode, a 1-Tbyte (2^{40} bytes) virtual address space (xuseg) can be used.

As shown in Tables 6-2 and 6-3, each virtual address is extended independently as another virtual address by setting an 8-bit address space ID area (ASID), to support user processes of up to 256. The contents of TLB can be retained after context switching by allocating each process by ASID. useg and xuseg can be referenced via TLB. Whether a cache is used or not is determined for each page by the TLB entry (depending on the C bit setting in the TLB entry).

The User segment starts at address 0 and the current active user process resides in either useg (in 32-bit mode) or xuseg (in 64-bit mode). The TLB identically maps all references to useg/xuseg from all modes, and controls cache accessibility.

The processor operates in User mode when the Status register contains the following bit-values:

- KSU = 10
- EXL = 0
- ERL = 0

In conjunction with these bits, the UX bit in the Status register selects 32- or 64-bit User mode addressing as follows:

- When UX = 0, 32-bit useg space is selected.
- When UX = 1, 64-bit xuseg space is selected.

Table 6-1 lists the characteristics of each user segment (useg and xuseg).

Figure 6-4. User Mode Address Space

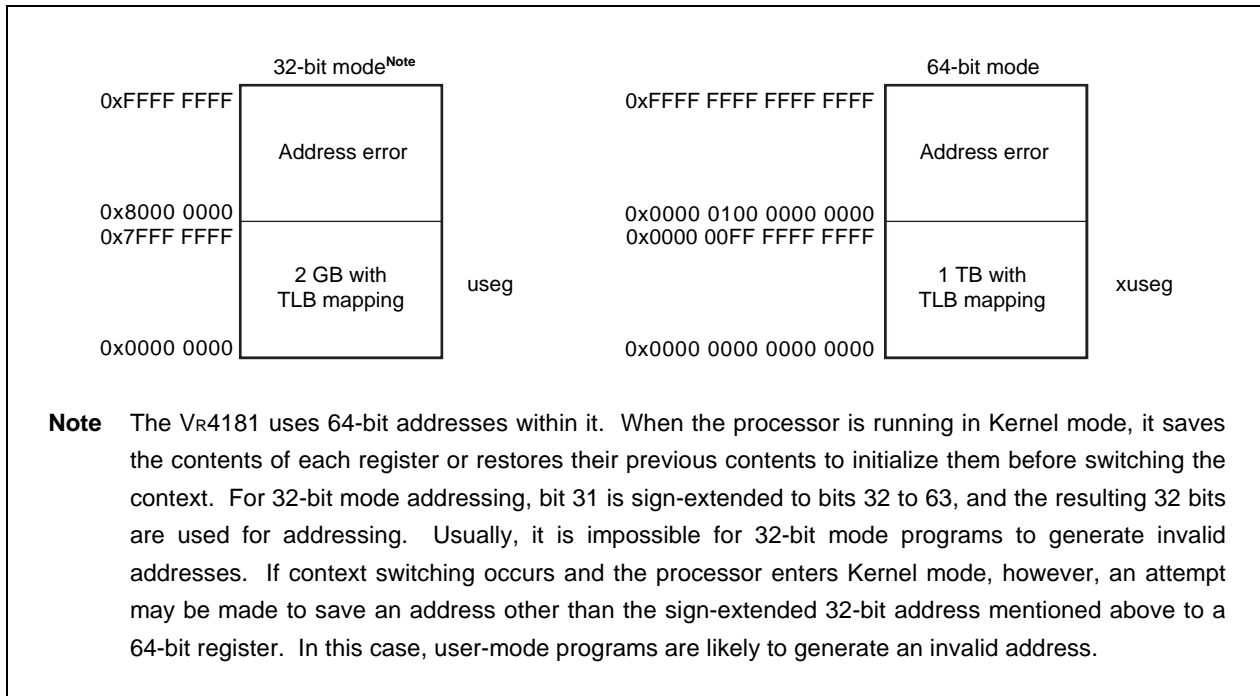

Table 6-1. Comparison of useg and xuseg

Address bit value	Status register bit value				Segment name	Address range	Size
	KSU	EXL	ERL	UX			
32-bit A31 = 0	10	0	0	0	useg	0x0000 0000 to 0x7FFF FFFF	2 Gbytes (2 ³¹ bytes)
64-bit A(63:40) = 0	10	0	0	1	xuseg	0x0000 0000 0000 0000 to 0x0000 00FF FFFF FFFF	1 Tbyte (2 ⁴⁰ bytes)

(1) useg (32-bit mode)

In User mode, when UX = 0 in the Status register and the most significant bit of the virtual address is 0, this virtual address space is labeled useg.

Any attempt to reference an address with the most-significant bit set while in User mode causes an Address Error exception (see **CHAPTER 7 EXCEPTION PROCESSING**).

The TLB Refill exception vector is used for TLB misses.

(2) xuseg (64-bit mode)

In User mode, when UX = 1 in the Status register and bits 63 to 40 of the virtual address are all 0, this virtual address space is labeled xuseg.

Any attempt to reference an address with bits 63:40 equal to 1 causes an Address Error exception (see **CHAPTER 7 EXCEPTION PROCESSING**).

The XTLB Refill exception vector is used for TLB misses.

6.2.6 Supervisor mode virtual addressing

Supervisor mode shown in Figure 6-5 is designed for layered operating systems in which a true kernel runs in Kernel mode, and the rest of the operating system runs in Supervisor mode.

All of the suseg, sseg, xsuseg, xsseg, and csseg spaces are referenced via TLB. Whether cache can be used or not is determined by bit C of each page's TLB entry.

The processor operates in Supervisor mode when the Status register contains the following bit-values:

- KSU = 01
- EXL = 0
- ERL = 0

In conjunction with these bits, the SX bit in the Status register selects 32- or 64-bit Supervisor mode addressing:

- When SX = 0, 32-bit supervisor space is selected.
- When SX = 1, 64-bit supervisor space is selected.

Figure 6-5 shows the supervisor mode address space, and Table 6-2 lists the characteristics of the Supervisor mode segments.

Figure 6-5. Supervisor Mode Address Space

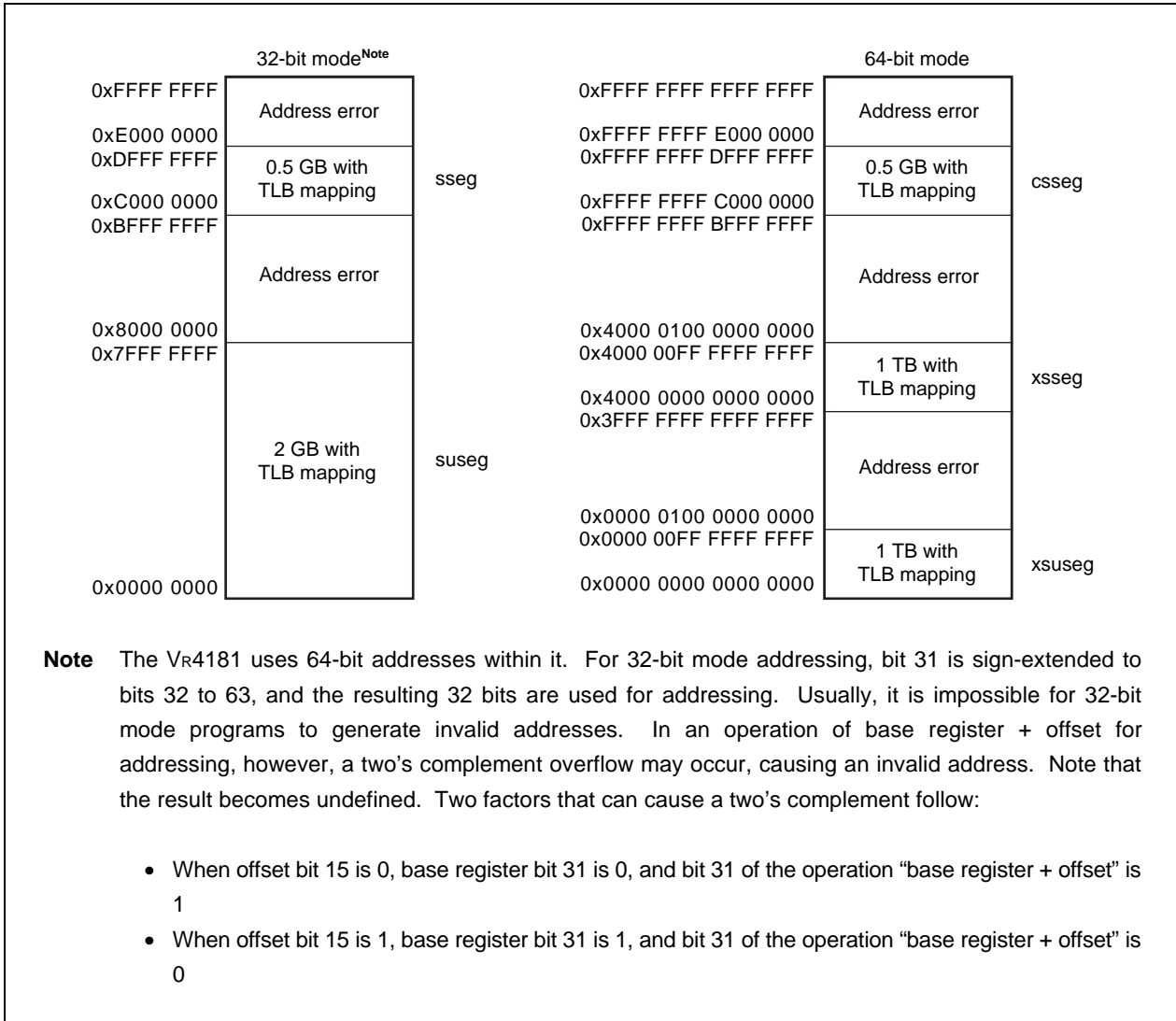

Table 6-2. 32-bit and 64-bit Supervisor Mode Segments

Address bit value	Status register bit value				Segment name	Address range	Size
	KSU	EXL	ERL	SX			
32-bit A31 = 0	01	0	0	0	suseg	0x0000 0000 to 0x7FFF FFFF	2 Gbytes (2 ³¹ bytes)
32-bit A(31:29) = 110	01	0	0	0	sseg	0xC000 0000 to 0xDFFF FFFF	512 Mbytes (2 ²⁹ bytes)
64-bit A(63:62) = 00	01	0	0	1	xsuseg	0x0000 0000 0000 0000 to 0x0000 00FF FFFF FFFF	1 Tbyte (2 ⁴⁰ bytes)
64-bit A(63:62) = 01	01	0	0	1	xsseg	0x4000 0000 0000 0000 to 0x4000 00FF FFFF FFFF	1 Tbyte (2 ⁴⁰ bytes)
64-bit A(63:62) = 11	01	0	0	1	csseg	0xFFFF FFFF C000 0000 to 0xFFFF FFFF DFFF FFFF	512 Mbytes (2 ²⁹ bytes)

(1) suseg (32-bit Supervisor mode, user space)

When SX = 0 in the Status register and the most-significant bit of the virtual address space is set to 0, the suseg virtual address space is selected; it covers 2 Gbytes (2³¹ bytes) of the current user address space. The virtual address is extended with the contents of the 8-bit ASID field to form a unique virtual address. This mapped space starts at virtual address 0x0000 0000 and runs through 0x7FFF FFFF.

(2) sseg (32-bit Supervisor mode, supervisor space)

When SX = 0 in the Status register and the three most-significant bits of the virtual address space are 110, the sseg virtual address space is selected; it covers 512 Mbytes (2²⁹ bytes) of the current supervisor virtual address space. The virtual address is extended with the contents of the 8-bit ASID field to form a unique virtual address. This mapped space begins at virtual address 0xC000 0000 and runs through 0xDFFF FFFF.

(3) xsuseg (64-bit Supervisor mode, user space)

When SX = 1 in the Status register and bits 63 and 62 of the virtual address space are set to 00, the xsuseg virtual address space is selected; it covers 1 Tbyte (2⁴⁰ bytes) of the current user address space. The virtual address is extended with the contents of the 8-bit ASID field to form a unique virtual address. This mapped space starts at virtual address 0x0000 0000 0000 0000 and runs through 0x0000 00FF FFFF FFFF.

(4) xsseg (64-bit Supervisor mode, current supervisor space)

When $SX = 1$ in the Status register and bits 63 and 62 of the virtual address space are set to 01, the xsseg virtual address space is selected; it covers 1 Tbyte (2^{40} bytes) of the current supervisor virtual address space. The virtual address is extended with the contents of the 8-bit ASID field to form a unique virtual address. This mapped space begins at virtual address 0x4000 0000 0000 0000 and runs through 0x4000 00FF FFFF FFFF.

(5) csseg (64-bit Supervisor mode, separate supervisor space)

When $SX = 1$ in the Status register and bits 63 and 62 of the virtual address space are set to 11, the csseg virtual address space is selected; it covers 512 Mbytes (2^{29} bytes) of the separate supervisor virtual address space. The virtual address is extended with the contents of the 8-bit ASID field to form a unique virtual address. This mapped space begins at virtual address 0xFFFF FFFF C000 0000 and runs through 0xFFFF FFFF DFFF FFFF.

6.2.7 Kernel mode virtual addressing

If the Status register satisfies any of the following conditions, the processor runs in Kernel mode.

- $KSU = 00$
- $EXL = 1$
- $ERL = 1$

The addressing width in Kernel mode varies according to the state of the KX bit of the Status register, as follows:

- When $KX = 0$, 32-bit kernel space is selected.
- When $KX = 1$, 64-bit kernel space is selected.

The processor enters Kernel mode whenever an exception is detected and it remains in Kernel mode until an exception return (ERET) instruction is executed and results in ERL and/or $EXL = 0$. The ERET instruction restores the processor to the mode existing prior to the exception.

Kernel mode virtual address space is divided into regions differentiated by the high-order bits of the virtual address, as shown in Figure 6-6. Table 6-3 lists the characteristics of the 32-bit Kernel mode segments, and Table 6-4 lists the characteristics of the 64-bit Kernel mode segments.

Figure 6-6. Kernel Mode Address Space

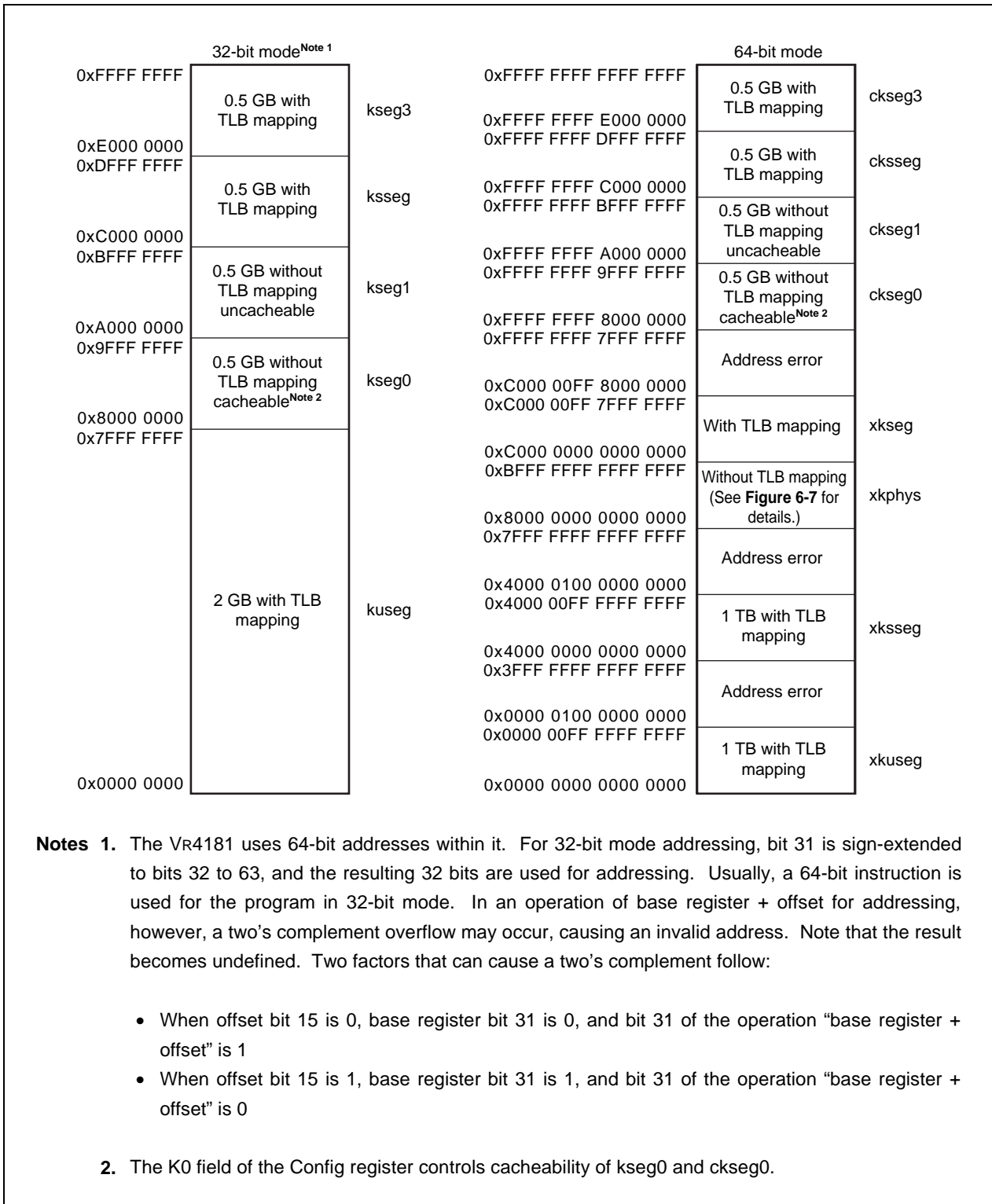

Figure 6-7. xkphys Area Address Space

0xBFFF FFFF FFFF FFFF	Address error
0xB800 0001 0000 0000 0xB800 0000 FFFF FFFF	4 GB without TLB mapping cacheable
0xB800 0000 0000 0000 0xB7FF FFFF FFFF FFFF	Address error
0xB000 0001 0000 0000 0xB000 0000 FFFF FFFF	4 GB without TLB mapping cacheable
0xB000 0000 0000 0000 0xAFFF FFFF FFFF FFFF	Address error
0xA800 0001 0000 0000 0xA800 0000 FFFF FFFF	4 GB without TLB mapping cacheable
0xA800 0000 0000 0000 0xA7FF FFFF FFFF FFFF	Address error
0xA000 0001 0000 0000 0xA000 0000 FFFF FFFF	4 GB without TLB mapping cacheable
0xA000 0000 0000 0000 0x9FFF FFFF FFFF FFFF	Address error
0x9800 0001 0000 0000 0x9800 0000 FFFF FFFF	4 GB without TLB mapping cacheable
0x9800 0000 0000 0000 0x97FF FFFF FFFF FFFF	Address error
0x9000 0001 0000 0000 0x9000 0000 FFFF FFFF	4 GB without TLB mapping uncacheable
0x9000 0000 0000 0000 0x8FFF FFFF FFFF FFFF	Address error
0x8800 0001 0000 0000 0x8800 0000 FFFF FFFF	4 GB without TLB mapping cacheable
0x8800 0000 0000 0000 0x87FF FFFF FFFF FFFF	Address error
0x8000 0001 0000 0000 0x8000 0000 FFFF FFFF	4 GB without TLB mapping cacheable
0x8000 0000 0000 0000	

Table 6-3. 32-bit Kernel Mode Segments

Address bit value	Status register bit value				Segment name	Virtual address	Physical address	Size
	KSU	EXL	ERL	KX				
32-bit A31 = 0	KSU = 00 or EXL = 1 or ERL = 1	0	kuseg	0x0000 0000 to 0x7FFF FFFF	TLB map	2 Gbytes (2 ³¹ bytes)		
32-bit A(31:29) = 100			kseg0	0x8000 0000 to 0x9FFF FFFF	0x0000 0000 to 0x1FFF FFFF	512 Mbytes (2 ²⁹ bytes)		
32-bit A(31:29) = 101			kseg1	0xA000 0000 to 0xBFFF FFFF	0x0000 0000 to 0x1FFF FFFF	512 Mbytes (2 ²⁹ bytes)		
32-bit A(31:29) = 110			ksseg	0xC000 0000 to 0xDFFF FFFF	TLB map	512 Mbytes (2 ²⁹ bytes)		
32-bit A(31:29) = 111			kseg3	0xE000 0000 to 0xFFFF FFFF	TLB map	512 Mbytes (2 ²⁹ bytes)		

(1) kuseg (32-bit Kernel mode, user space)

When KX = 0 in the Status register, and the most-significant bit of the virtual address space is 0, the kuseg virtual address space is selected; it is the current 2-Gbyte (2³¹-byte) user address space.

The virtual address is extended with the contents of the 8-bit ASID field to form a unique virtual address.

References to kuseg are mapped through TLB. Whether cache can be used or not is determined by bit C of each page's TLB entry.

If the ERL bit of the Status register is 1, the user address space is assigned 2 Gbytes (2³¹ bytes) without TLB mapping and becomes unmapped (with virtual addresses being used as physical addresses) and uncached so that the cache error handler can use it. This allows the Cache Error exception code to operate uncached using r0 as a base register.

(2) kseg0 (32-bit Kernel mode, kernel space 0)

When KX = 0 in the Status register and the most-significant three bits of the virtual address space are 100, the kseg0 virtual address space is selected; it is the current 512-Mbyte (2²⁹-byte) physical space.

References to kseg0 are not mapped through TLB; the physical address selected is defined by subtracting 0x8000 0000 from the virtual address.

The K0 field of the Config register controls cacheability.

(3) kseg1 (32-bit Kernel mode, kernel space 1)

When $KX = 0$ in the Status register and the most-significant three bits of the virtual address space are 101, the kseg1 virtual address space is selected; it is the current 512-Mbyte (2^{29} -byte) physical space.

References to kseg1 are not mapped through TLB; the physical address selected is defined by subtracting 0xA000 0000 from the virtual address.

Caches are disabled for accesses to these addresses, and main memory (or memory-mapped I/O device registers) is accessed directly.

(4) ksseg (32-bit Kernel mode, supervisor space)

When $KX = 0$ in the Status register and the most-significant three bits of the virtual address space are 110, the ksseg virtual address space is selected; it is the current 512-Mbyte (2^{29} -byte) virtual address space. The virtual address is extended with the contents of the 8-bit ASID field to form a unique virtual address.

References to ksseg are mapped through TLB. Whether cache can be used or not is determined by bit C of each page's TLB entry.

(5) kseg3 (32-bit Kernel mode, kernel space 3)

When $KX = 0$ in the Status register and the most-significant three bits of the virtual address space are 111, the kseg3 virtual address space is selected; it is the current 512-Mbyte (2^{29} -byte) kernel virtual space. The virtual address is extended with the contents of the 8-bit ASID field to form a unique virtual address.

References to kseg3 are mapped through TLB. Whether cache can be used or not is determined by bit C of each page's TLB entry.

Table 6-4. 64-bit Kernel Mode Segments

Address bit value	Status register bit value				Segment name	Virtual address	Physical address	Size																																			
	KSU	EXL	ERL	KX																																							
64-bit A(63:62) = 00	KSU = 00 or EXL = 1 or ERL = 1	1	1	xkuseg	0x0000 0000 0000 0000 to 0x0000 00FF FFFF FFFF	TLB map	1 Tbyte (2 ⁴⁰ bytes)																																				
64-bit A(63:62) = 01								1	1	xksseg	0x4000 0000 0000 0000 to 0x4000 00FF FFFF FFFF	TLB map	1 Tbyte (2 ⁴⁰ bytes)																														
64-bit A(63:62) = 10														1	1	xkphys	0x8000 0000 0000 0000 to 0xBFFF FFFF FFFF FFFF	0x0000 0000 to 0xFFFF FFFF	4 Gbytes (2 ³² bytes)																								
64-bit A(63:62) = 11																				1	1	xkseg	0xC000 0000 0000 0000 to 0xC000 00FF 7FFF FFFF	TLB map	2 ⁴⁰ - 2 ³¹ bytes																		
64-bit A(63:62) = 11 A(63:31) = -1																										1	1	ckseg0	0xFFFF FFFF 8000 0000 to 0xFFFF FFFF 9FFF FFFF	0x0000 0000 to 0x1FFF FFFF	512 Mbytes (2 ²⁹ bytes)												
64-bit A(63:62) = 11 A(63:31) = -1																																1	1	ckseg1	0xFFFF FFFF A000 0000 to 0xFFFF FFFF BFFF FFFF	0x0000 0000 to 0x1FFF FFFF	512 Mbytes (2 ²⁹ bytes)						
64-bit A(63:62) = 11 A(63:31) = -1																																						1	1	cksseg	0xFFFF FFFF C000 0000 to 0xFFFF FFFF DFFF FFFF	TLB map	512 Mbytes (2 ²⁹ bytes)
64-bit A(63:62) = 11 A(63:31) = -1																																											

(6) xkuseg (64-bit Kernel mode, user space)

When KX = 1 in the Status register and bits 63 and 62 of the virtual address space are 00, the xkuseg virtual address space is selected; it is the 1-Tbyte (2⁴⁰-byte) current user address space. The virtual address is extended with the contents of the 8-bit ASID field to form a unique virtual address.

References to xkuseg are mapped through TLB. Whether cache can be used or not is determined by bit C of each page's TLB entry.

If the ERL bit of the Status register is 1, the user address space is assigned 2 Gbytes (2³¹ bytes) without TLB mapping and becomes unmapped (with virtual addresses being used as physical addresses) and uncached so that the cache error handler can use it. This allows the Cache Error exception code to operate uncached using r0 as a base register.

(7) xksseg (64-bit Kernel mode, current supervisor space)

When KX = 1 in the Status register and bits 63 and 62 of the virtual address space are 01, the xksseg address space is selected; it is the 1-Tbyte (2⁴⁰-byte) current supervisor address space. The virtual address is extended with the contents of the 8-bit ASID field to form a unique virtual address.

References to xksseg are mapped through TLB. Whether cache can be used or not is determined by bit C of each page's TLB entry.

(8) xkphys (64-bit Kernel mode, physical spaces)

When the KX = 1 in the Status register and bits 63 and 62 of the virtual address space are 10, the virtual address space is called xkphys and selected as either cached or uncached. If any of bits 58 to 32 of the address is 1, an attempt to access that address results in an address error.

Whether cache can be used or not is determined by bits 59 to 61 of the virtual address. Table 6-5 shows cacheability corresponding to 8 address spaces.

Table 6-5. Cacheability and the xkphys Address Space

Bits 61 to 59	Cacheability	Address range
0	Cached	0x8000 0000 0000 0000 to 0x8000 0000 FFFF FFFF
1	Cached	0x8800 0000 0000 0000 to 0x8800 0000 FFFF FFFF
2	Uncached	0x9000 0000 0000 0000 to 0x9000 0000 FFFF FFFF
3	Cached	0x9800 0000 0000 0000 to 0x9800 0000 FFFF FFFF
4	Cached	0xA000 0000 0000 0000 to 0xA000 0000 FFFF FFFF
5	Cached	0xA800 0000 0000 0000 to 0xA800 0000 FFFF FFFF
6	Cached	0xB000 0000 0000 0000 to 0xB000 0000 FFFF FFFF
7	Cached	0xB800 0000 0000 0000 to 0xB800 0000 FFFF FFFF

(9) xksege (64-bit Kernel mode, kernel spaces)

When the KX = 1 in the Status register and bits 63 and 62 of the virtual address space are 11, the virtual address space is called xksege and selected as either of the following:

- Kernel virtual space, xksege, the current kernel virtual space; the virtual address is extended with the contents of the 8-bit ASID field to form a unique virtual address
References to xksege are mapped through TLB. Whether cache can be used or not is determined by bit C of each page's TLB entry.
- one of the four 32-bit kernel compatibility spaces, as described in the next section.

(10) 64-bit Kernel mode compatible spaces (ckseg0, ckseg1, cksseg, and ckseg3)

If the conditions listed below are satisfied in Kernel mode, ckseg0, ckseg1, cksseg, or ckseg3 (each having 512 Mbytes) is selected as a compatible space according to the state of the bits 30 and 29 (two low-order bits) of the address.

- The KX bit of the Status register is 1.
- Bits 63 and 62 of the 64-bit virtual address are 11.
- Bits 61 to 31 of the virtual address are all 1.

(a) ckseg0

This space is an unmapped region, compatible with the 32-bit mode kseg0 space. The K0 field of the Config register controls cacheability and coherency.

(b) ckseg1

This space is an unmapped and uncached region, compatible with the 32-bit mode kseg1 space.

(c) cksseg

This space is the current supervisor virtual space, compatible with the 32-bit mode ksseg space. References to cksseg are mapped through TLB. Whether cache can be used or not is determined by bit C of each page's TLB entry.

(d) ckseg3

This space is the current supervisor virtual space, compatible with the 32-bit mode kseg3 space. References to ckseg3 are mapped through TLB. Whether cache can be used or not is determined by bit C of each page's TLB entry.

6.3 Physical Address Space

Using a 32-bit address, the processor physical address space encompasses 4 Gbytes. The VR4181 uses this 4-Gbyte physical address space as shown in Figure 6-8.

Figure 6-8. VR4181 Physical Address Space

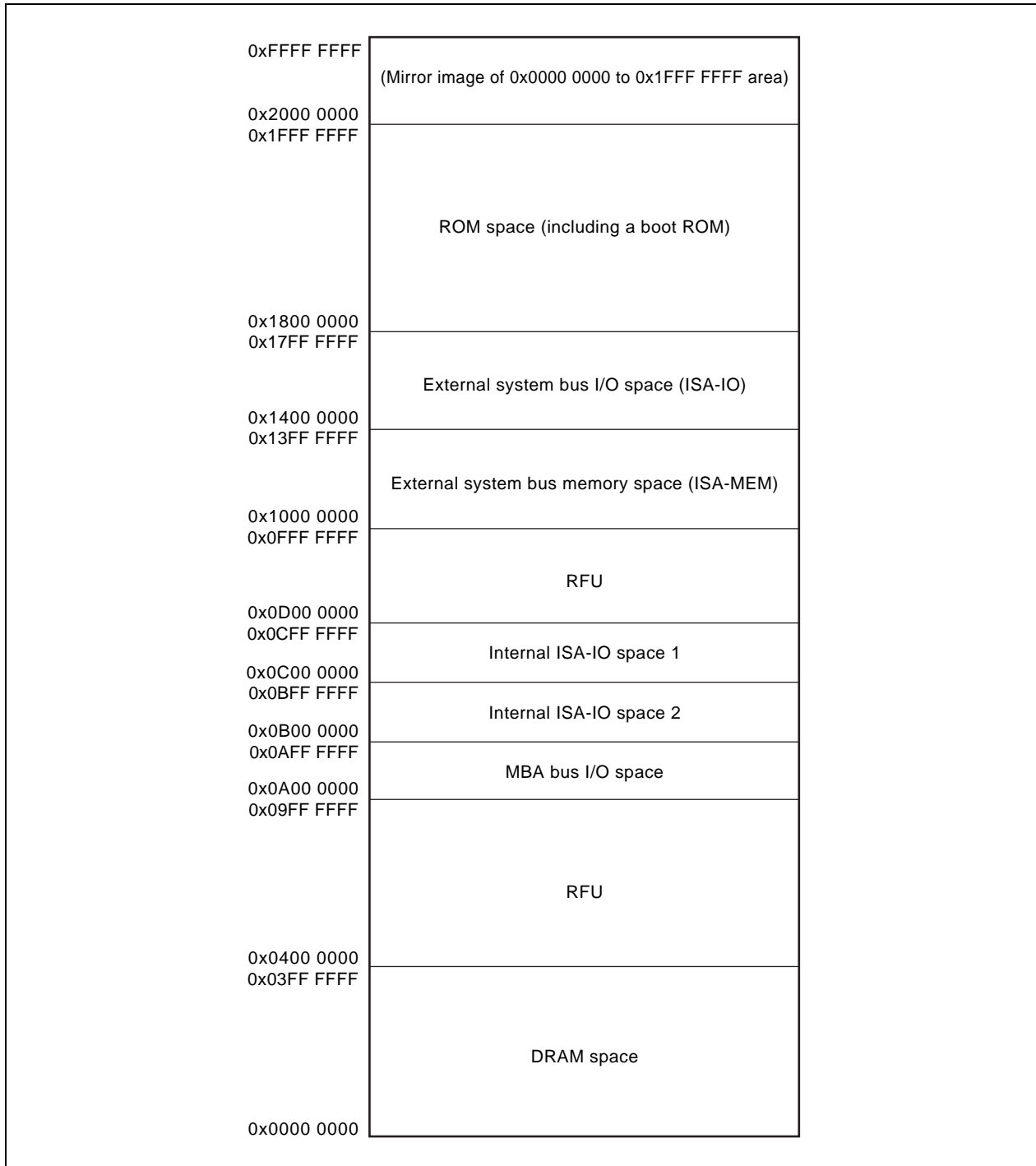

Table 6-6. VR4181 Physical Address Space

Physical address	Space	Capacity (bytes)
0xFFFF FFFF to 0x2000 0000	Mirror image of 0x1FFF FFFF to 0x0000 0000	3.5 G
0x1FFF FFFF to 0x1800 0000	ROM space	128 M
0x17FF FFFF to 0x1400 0000	External system bus I/O space (ISA-I/O)	64 M
0x13FF FFFF to 0x1000 0000	External system bus memory space (ISA-MEM)	64 M
0x0FFF FFFF to 0x0D00 0000	Space reserved for future use	48 M
0x0CFF FFFF to 0x0C00 0000	Internal ISA-I/O space 1	16 M
0x0BFF FFFF to 0x0B00 0000	Internal ISA-I/O space 2	16 M
0x0AFF FFFF to 0x0A00 0000	MBA bus I/O space	16 M
0x09FF FFFF to 0x0400 0000	Space reserved for future use	96 M
0x03FF FFFF to 0x0000 0000	DRAM (SDRAM) space	64 M

6.3.1 ROM space

The ROM space mapping differs depending on the capacity of the ROM being used. The ROM capacity is set via the ROMs(1:0) bits in the BCUNTREG1 register.

The physical addresses of the ROM space are listed below.

Table 6-7. ROM Address Map

Physical address	When using 32-Mbit ROM	When using 64-Mbit ROM
0x1FFF FFFF to 0x1FC0 0000	Bank 3 (ROMCS3#)	Bank 3 (ROMCS3#)
0x1FBF FFFF to 0x1F80 0000	Bank 2 (ROMCS2#)	
0x1F7F FFFF to 0x1F40 0000	Bank 1 (ROMCS1#)	Bank 2 (ROMCS2#)
0x1F3F FFFF to 0x1F00 0000	Bank 0 (ROMCS0#)	
0x1EFF FFFF to 0x1E80 0000	Reserved for future use	Bank 1 (ROMCS1#)
0x1E7F FFFF to 0x1E00 0000		Bank 0 (ROMCS0#)

6.3.2 External system bus space

The following two types of system bus space are available.

- External system bus I/O space
This corresponds to the ISA's I/O space.
- External system bus memory space
This corresponds to the ISA's memory space.

6.3.3 Internal I/O space

The VR4181 has three internal I/O spaces. Each of these spaces is described below.

Table 6-8. Internal I/O Space 1

Physical address	Internal I/O
0x0C00 001F to 0x0C00 0010	SIU1
0x0C00 000F to 0x0C00 0000	SIU2

Table 6-9. Internal I/O Space 2

Physical address	Internal I/O
0x0B00 09FF to 0x0B00 0900	CSI
0x0B00 08FF to 0x0B00 0800	ECU
0x0B00 07FF to 0x0B00 0400	Reserved for future use
0x0B00 03FF to 0x0B00 0300	GIU
0x0B00 02FF to 0x0B00 02D0	Reserved for future use
0x0B00 02CF to 0x0B00 02C0	ISA Bridge
0x0B00 02BF to 0x0B00 02A0	PIU-2
0x0B00 029F to 0x0B00 0280	Reserved for future use
0x0B00 027F to 0x0B00 0260	A/D test
0x0B00 025F to 0x0B00 0240	LED
0x0B00 023F to 0x0B00 01E0	Reserved for future use
0x0B00 01DF to 0x0B00 01C0	RTC-2
0x0B00 01BF to 0x0B00 01A0	Reserved for future use
0x0B00 019F to 0x0B00 0180	KIU
0x0B00 017F to 0x0B00 0160	AIU
0x0B00 015F to 0x0B00 0140	Reserved for future use
0x0B00 013F to 0x0B00 0120	PIU-1
0x0B00 011F to 0x0B00 0100	Reserved for future use
0x0B00 00FF to 0x0B00 00E0	DSU
0x0B00 00DF to 0x0B00 00C0	RTC-1
0x0B00 00BF to 0x0B00 00A0	PMU
0x0B00 009F to 0x0B00 0080	ICU-3
0x0B00 007F to 0x0B00 0000	Reserved for future use

Table 6-10. MBA Bus I/O Space

Physical address	Internal I/O
0x0A00 06FF to 0x0A00 0600	DCU-2
0x0A00 05FF to 0x0A00 0500	Reserved for future use
0x0A00 04FF to 0x0A00 0400	LCD controller
0x0A00 03FF to 0x0A00 0300	Memory controller
0x0A00 02FF to 0x0A00 0220	Reserved for future use
0x0A00 021F to 0x0A00 0200	ICU-2
0x0A00 01FF to 0x0A00 00A0	Reserved for future use
0x0A00 009F to 0x0A00 0080	ICU-1
0x0A00 007F to 0x0A00 0050	Reserved for future use
0x0A00 004F to 0x0A00 0020	DCU-1
0x0A00 001F to 0x0A00 0000	MBA host bridge

6.3.4 DRAM space

The DRAM space differs depending on the capacity of the DRAM being used. The DRAM capacity is set via the B1Config(1:0) bits in the MEMCFG_REG register.

The physical addresses of the DRAM space are listed below.

Table 6-11. DRAM Address Map

Physical address	When using 16-Mbit DRAM	When using 64-Mbit DRAM
0x007F FFFF to 0x0040 0000	Reserved for future use	Bank 1 (RAS1#/SDCS1#)
0x003F FFFF to 0x0020 0000	Bank 1 (RAS1#/SDCS1#)	Bank 0 (RAS0#/SDCS0#)
0x001F FFFF to 0x0000 0000	Bank 0 (RAS0#/SDCS0#)	

6.4 System Control Coprocessor

The System Control Coprocessor (CP0) is implemented as an integral part of the CPU, and supports memory management, address translation, exception handling, and other privileged operations. The CP0 contains the registers and a 32-entry TLB shown in Figure 6-9. The sections that follow describe how the processor uses each of the memory management-related registers.

Remark Each CP0 register has a unique number that identifies it; this number is referred to as the register number. See Chapter 1 for details. Also see Chapter 7 for the CP0 functions and the relationships between exception processing and registers.

Figure 6-9. CP0 Registers and the TLB

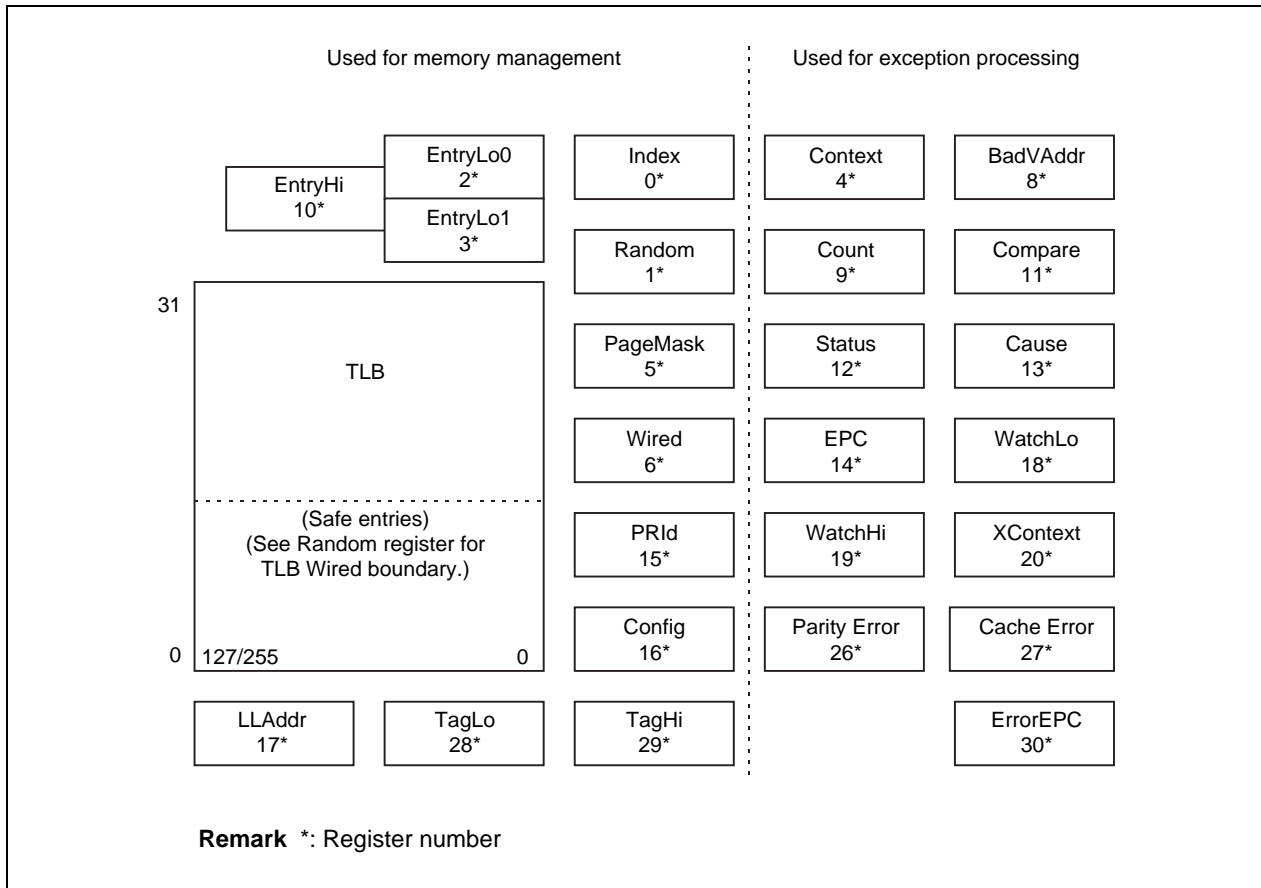

Caution When accessing the CP0 register, some instructions require consideration of the interval time until the next instruction is executed, because it takes a while from when the contents of the CP0 register change to when this change is reflected on the CPU operation. This time lag is called CP0 hazard. For details, see Chapter 29.

6.4.1 Format of a TLB entry

Figure 6-10 shows the TLB entry formats for both 32- and 64-bit modes. Each field of an entry has a corresponding field in the EntryHi, EntryLo0, EntryLo1, or PageMask registers.

Figure 6-10. Format of a TLB Entry

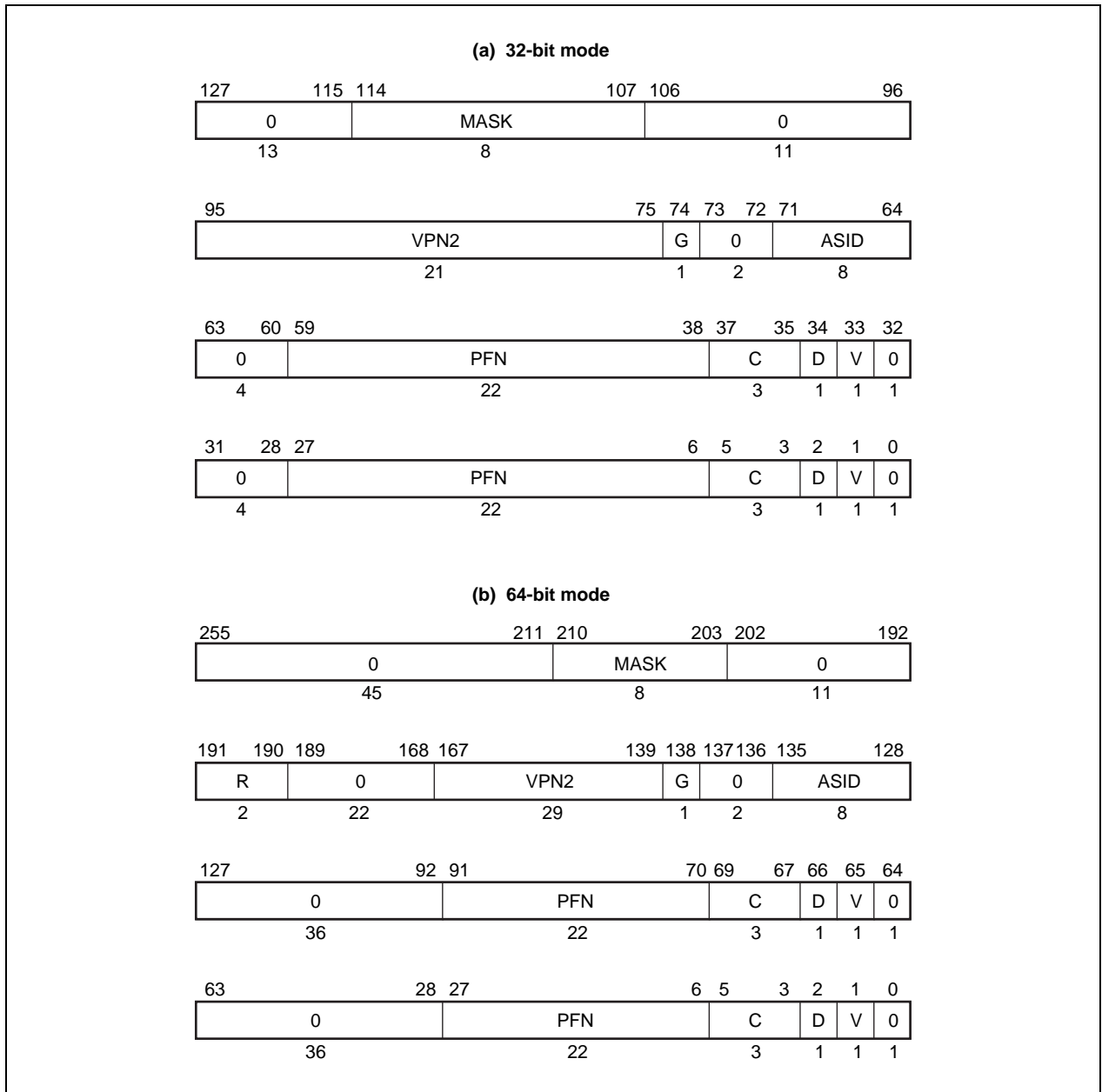

The format of the EntryHi, EntryLo0, EntryLo1, and PageMask registers are nearly the same as the TLB entry. However, the bit in the EntryHi register that corresponds to the TLB G bit is undefined.

6.5 CP0 Registers

The CP0 registers explained below are accessed by the memory management system and software. The parenthesized number that follows each register name is the register number.

6.5.1 Index register (0)

The Index register is a 32-bit, read/write register containing five low-order bits to index an entry in the TLB. The most-significant bit of the register shows the success or failure of a TLB probe (TLBP) instruction.

The Index register also specifies the TLB entry affected by TLB read (TLBR) or TLB write index (TLBWI) instructions.

Figure 6-11. Index Register

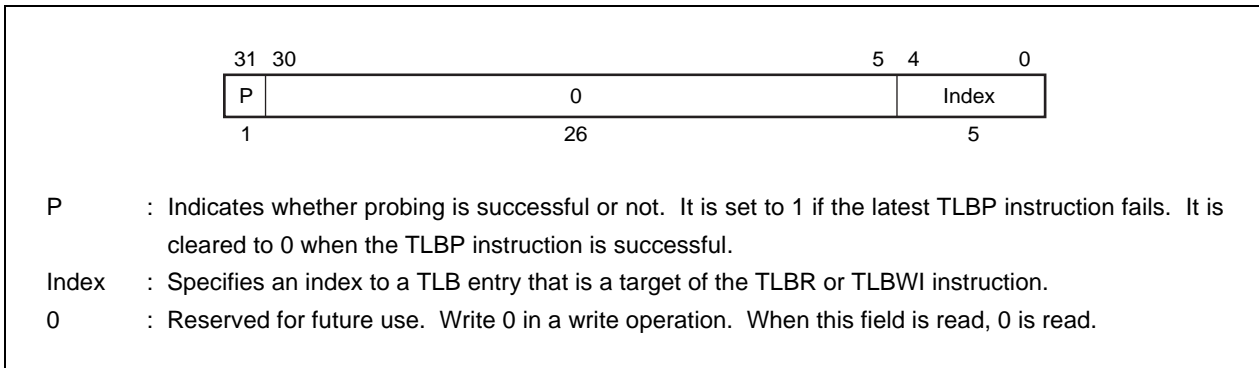

6.5.2 Random register (1)

The Random register is a read-only register. The low-order 5 bits are used in referencing a TLB entry. This register is decremented each time an instruction is executed. The values that can be set in the register are as follows:

- The lower bound is the content of the Wired register.
- The upper bound is 31.

The Random register specifies the entry in the TLB that is affected by the TLBWR instruction. The register is readable to verify proper operation of the processor.

The Random register is set to the value of the upper bound upon Cold Reset. This register is also set to the upper bound when the Wired register is written. Figure 6-12 shows the format of the Random register.

Figure 6-12. Random Register

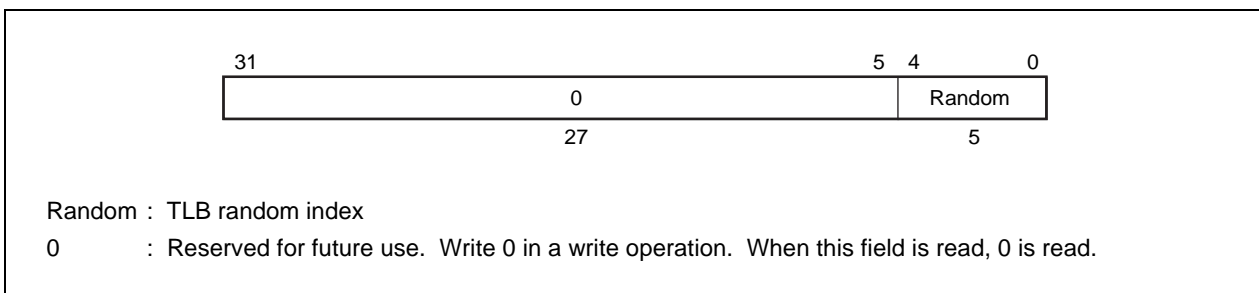

6.5.3 EntryLo0 (2) and EntryLo1 (3) registers

The EntryLo register consists of two registers that have identical formats: EntryLo0, used for even virtual pages and EntryLo1, used for odd virtual pages. The EntryLo0 and EntryLo1 registers are both read-/write-accessible. They are used to access the built-in TLB. When a TLB read/write operation is carried out, the EntryLo0 and EntryLo1 registers hold the contents of the low-order 32 bits of TLB entries at even and odd addresses, respectively.

Figure 6-13. EntryLo0 and EntryLo1 Registers

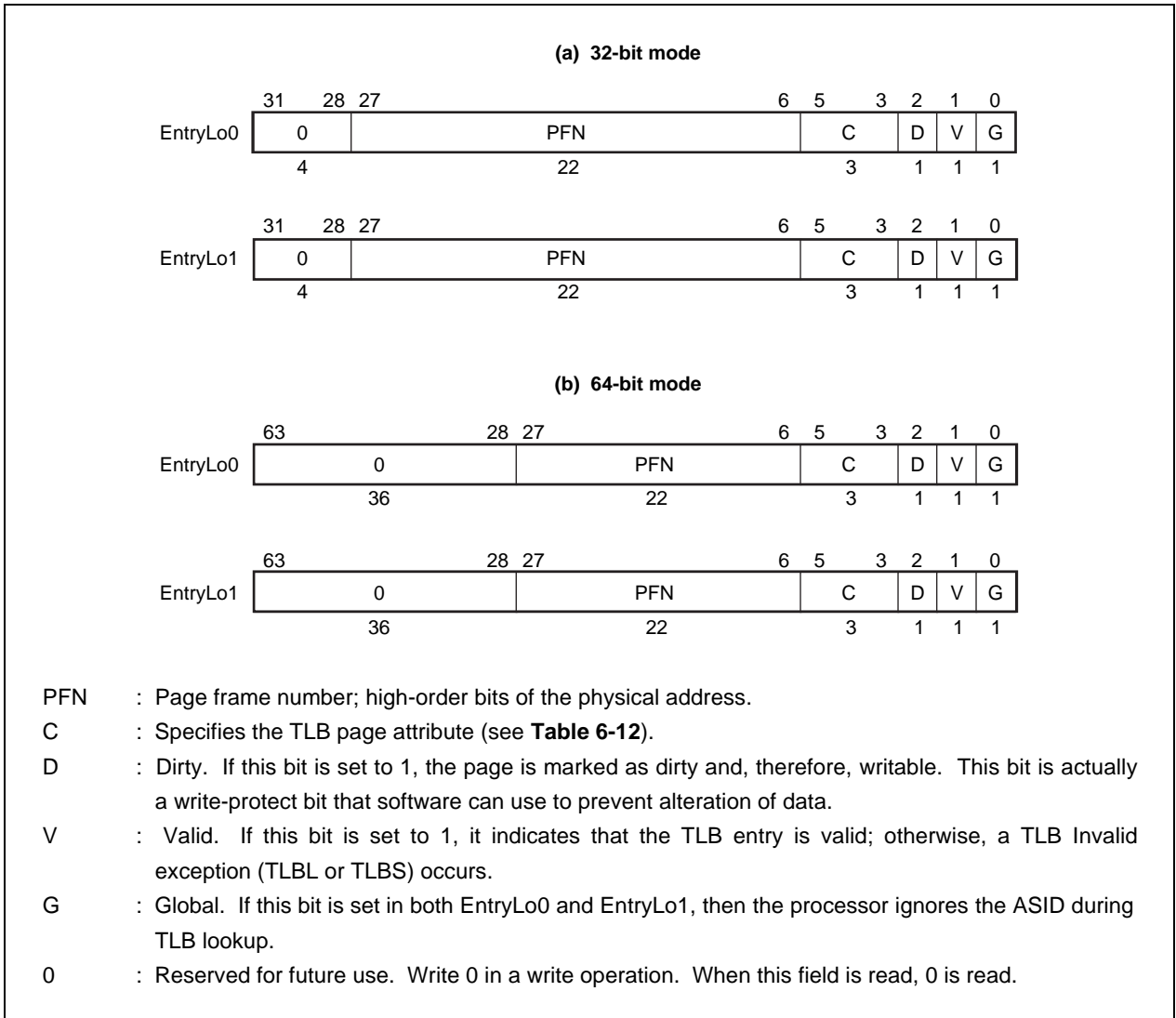

The coherency attribute (C) bits are used to specify whether to use the cache in referencing a page. When the cache is used, whether the page attribute is “cached” or “uncached” is selected by algorithm.

Table 6-12 lists the page attributes selected according to the value in the C bits.

Table 6-12. Cache Algorithm

C bit value	Cache algorithm
0	Cached
1	Cached
2	Uncached
3	Cached
4	Cached
5	Cached
6	Cached
7	Cached

6.5.4 PageMask register (5)

The PageMask register is a read/write register used for reading from or writing to the TLB; it holds a comparison mask that sets the page size for each TLB entry, as shown in Table 6-13. Page sizes must be from 1 Kbyte to 256 Kbytes.

TLB read and write instructions use this register as either a source or a destination; Bits 18 to 11 that are targets of comparison are masked during address translation.

Figure 6-14. Page Mask Register

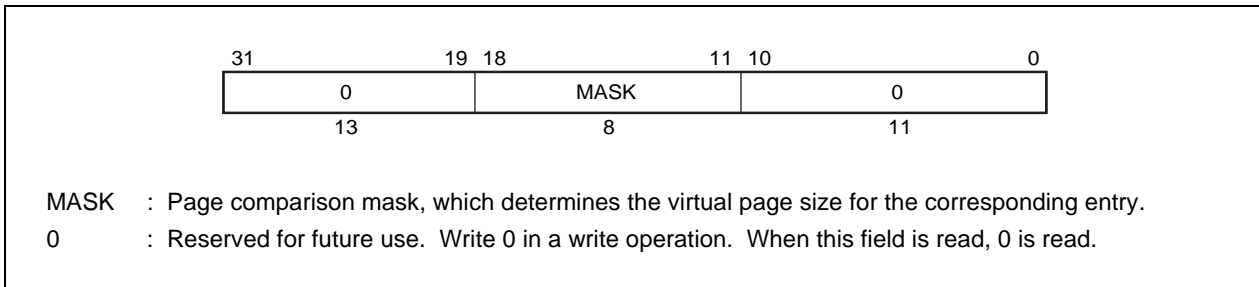

Table 6-13 lists the mask pattern for each page size. If the mask pattern is one not listed below, the TLB behaves unexpectedly.

Table 6-13. Mask Values and Page Sizes

Page size	Bit							
	18	17	16	15	14	13	12	11
1 Kbyte	0	0	0	0	0	0	0	0
4 Kbytes	0	0	0	0	0	0	1	1
16 Kbytes	0	0	0	0	1	1	1	1
64 Kbytes	0	0	1	1	1	1	1	1
256 Kbytes	1	1	1	1	1	1	1	1

6.5.5 Wired register (6)

The Wired register is a read/write register that specifies the lower boundary of the random entry of the TLB as shown in Figure 6-15. Wired entries cannot be overwritten by a TLBWR instruction. They can, however, be overwritten by a TLBWI instruction. Random entries can be overwritten by both instructions.

Figure 6-15. Positions Indicated by the Wired Register

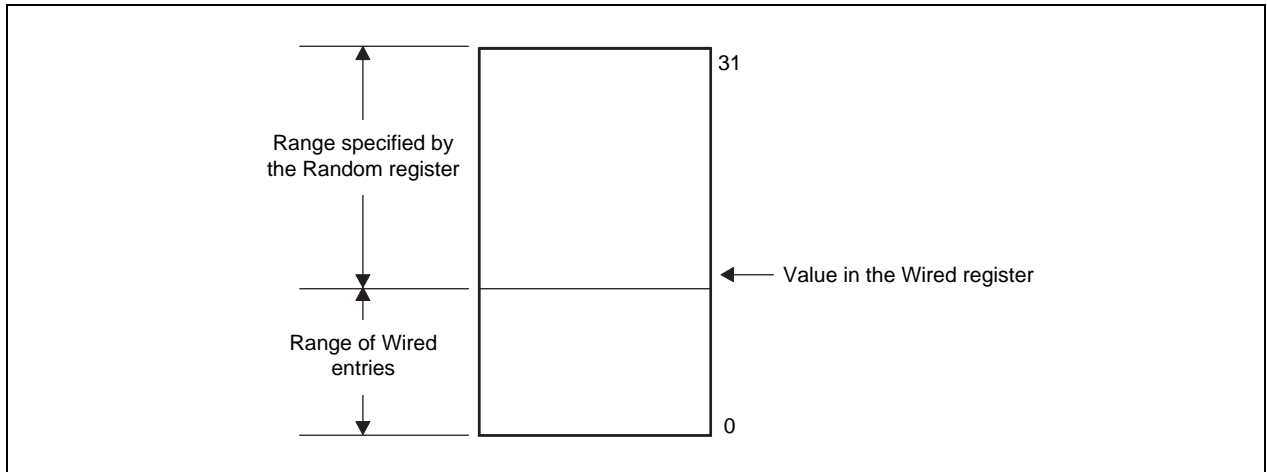

The Wired register is set to 0 upon Cold Reset. Writing this register also sets the Random register to the value of its upper bound (see 6.5.2 **Random register (1)**). Figure 6-16 shows the format of the Wired register.

Figure 6-16. Wired Register

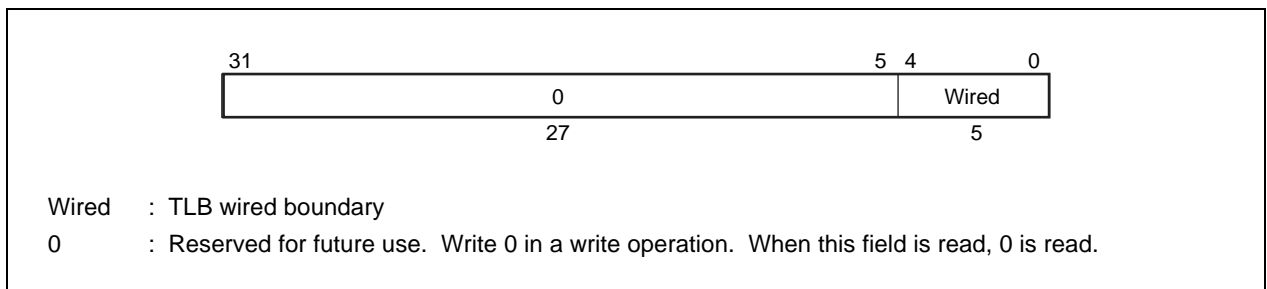

6.5.6 EntryHi register (10)

The EntryHi register is write-accessible. It is used to access the built-in TLB. The EntryHi register holds the high-order bits of a TLB entry for TLB read and write operations. If a TLB Refill, TLB Invalid, or TLB Modified exception occurs, the EntryHi register holds the high-order bit of the TLB entry. The EntryHi register is also set with the virtual page number (VPN2) for a virtual address where an exception occurred and the ASID. See Chapter 7 for details of the TLB exception.

The ASID is used to read from or write to the ASID field of the TLB entry. It is also checked with the ASID of the TLB entry as the ASID of the virtual address during address translation.

The EntryHi register is accessed by the TLBP, TLBWR, TLBWI, and TLBR instructions.

Figure 6-17. EntryHi Register

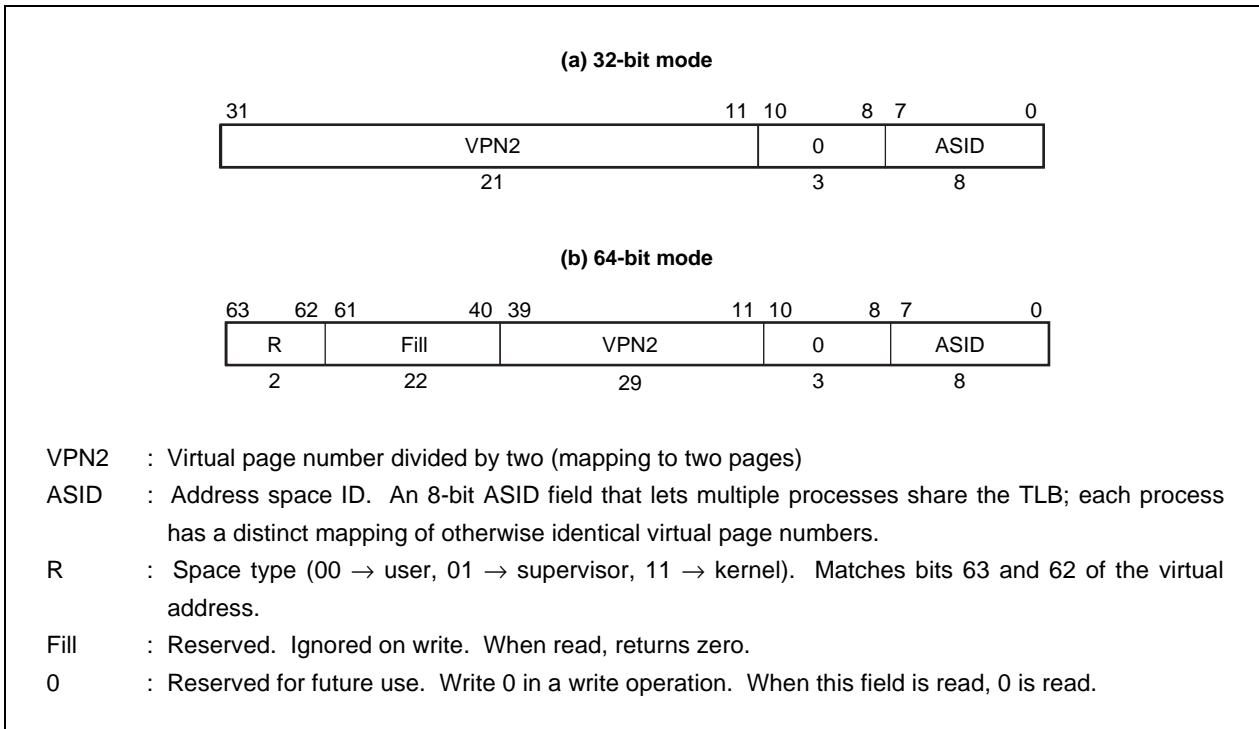

6.5.7 Processor revision identifier (PRId) register (15)

The 32-bit, read-only Processor Revision Identifier (PRId) register contains information identifying the implementation and revision level of the CPU and CP0. Figure 6-18 shows the format of the PRId register.

Figure 6-18. PRId Register

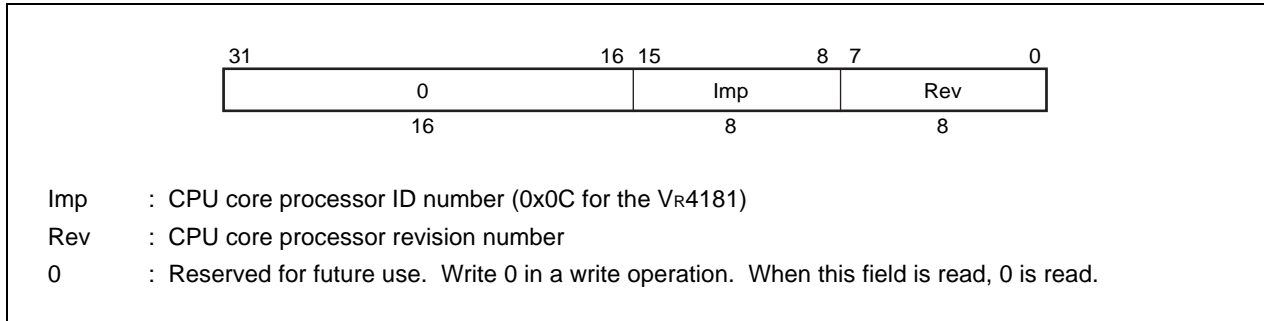

The low-order byte (bits 7:0) of the PRId register is interpreted as a revision number, and the high-order byte (bits 15:8) is interpreted as an implementation number. The processor revision number is stored as a value in the form y.x, where y is a major revision number in bits 7 to 4 and x is a minor revision number in bits 3 to 0.

The processor revision number can distinguish some CPU core revisions, however there is no guarantee that changes to the CPU core will necessarily be reflected in the PRId register, or that changes to the revision number necessarily reflect real CPU core changes. Therefore, create a program that does not depend on the processor revision number area.

6.5.8 Config register (16)

The Config register specifies various configuration options selected on Vr4181 processors.

Some configuration options, as defined by the EC and BE fields, are set by the hardware during Cold Reset and are included in the Config register as read-only status bits for the software to access. Other configuration options are read/write (AD, EP, and K0 fields) and controlled by software; on Cold Reset these fields are undefined. Since only a subset of the Vr4000 Series options are available in the Vr4181, some bits are set to constants (e.g., bits 14:13) that were variable in the Vr4000 Series. The Config register should be initialized by software before caches are used. Figure 6-19 shows the format of the Config register.

Figure 6-19. Config Register Format (1/2)

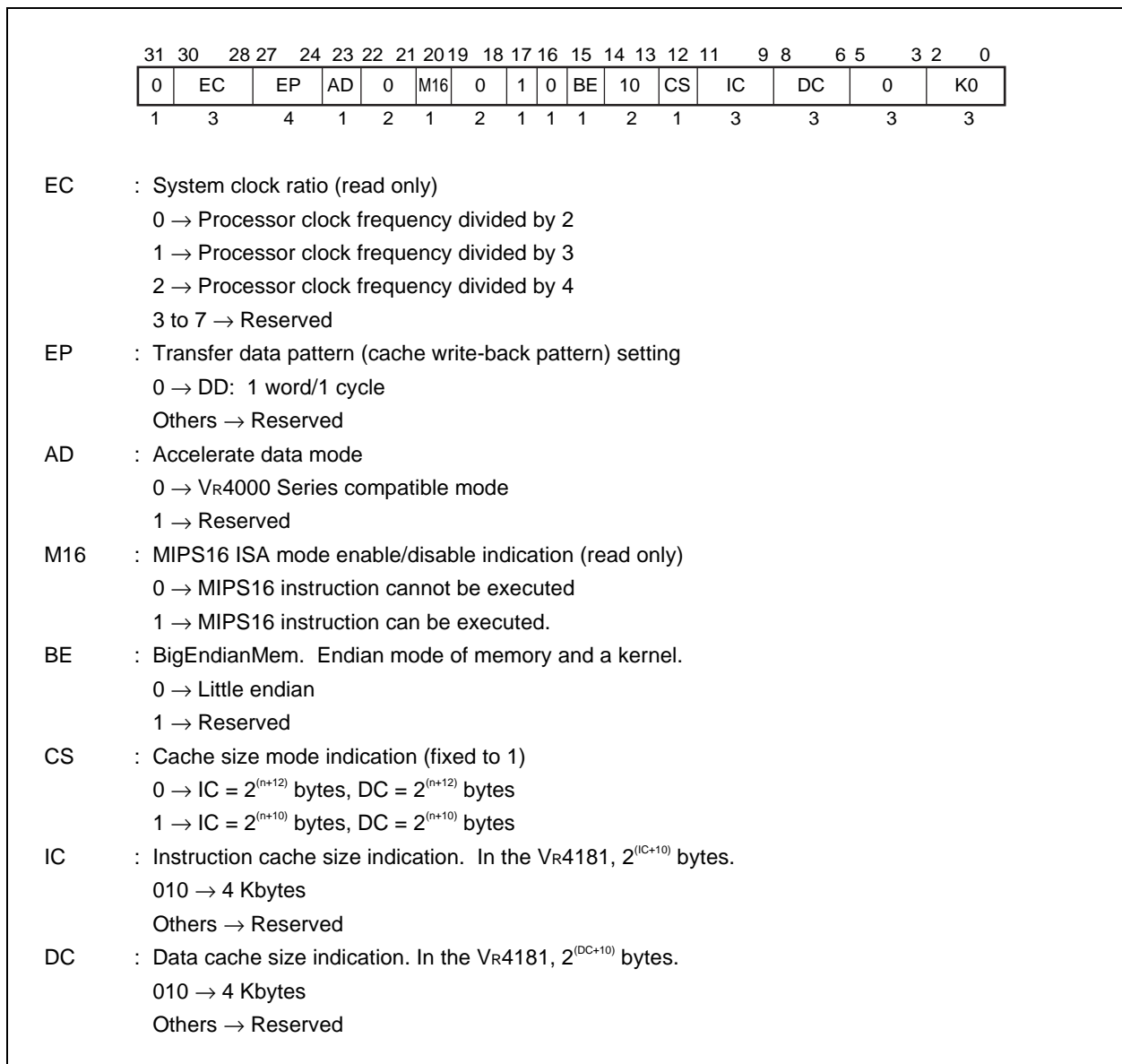
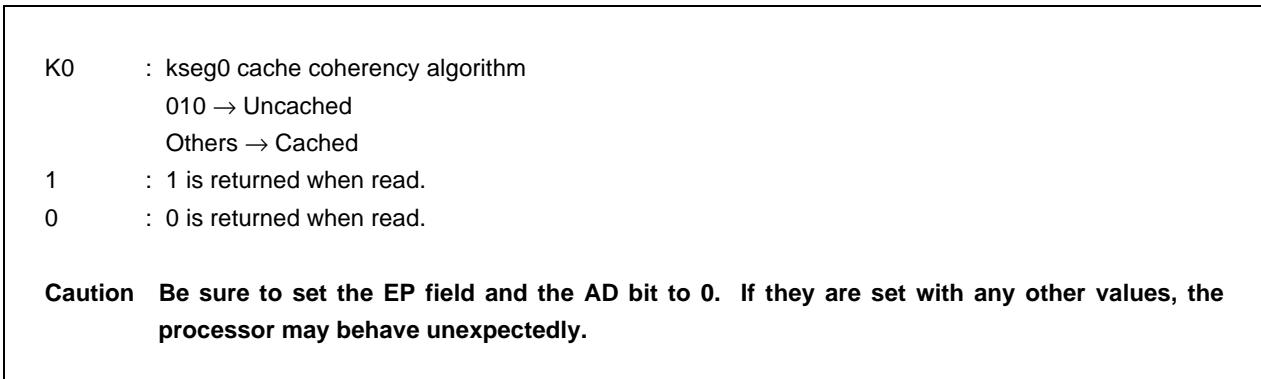

Figure 6-19. Config Register Format (2/2)



6.5.9 Load linked address (LLAddr) register (17)

The read/write Load Linked Address (LLAddr) register is not used with the VR4181 processor except for diagnostic purpose, and serves no function during normal operation.

LLAddr register is implemented just for compatibility between the VR4181 and VR4000/VR4400.

Figure 6-20. LLAddr Register

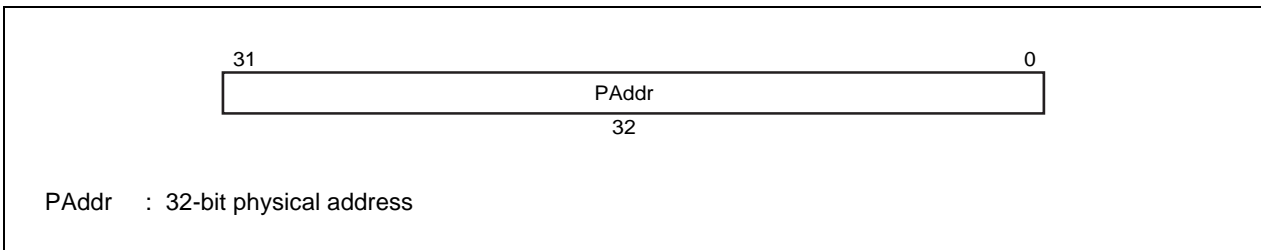

6.5.10 Cache tag registers (TagLo (28) and TagHi (29))

The TagLo and TagHi registers are 32-bit read/write registers that hold the primary cache tag during cache initialization, cache diagnostics, or cache error processing. The Tag registers are written by the CACHE and MTC0 instructions.

Figures 6-21 and 6-22 show the format of these registers.

Figure 6-21. TagLo Register

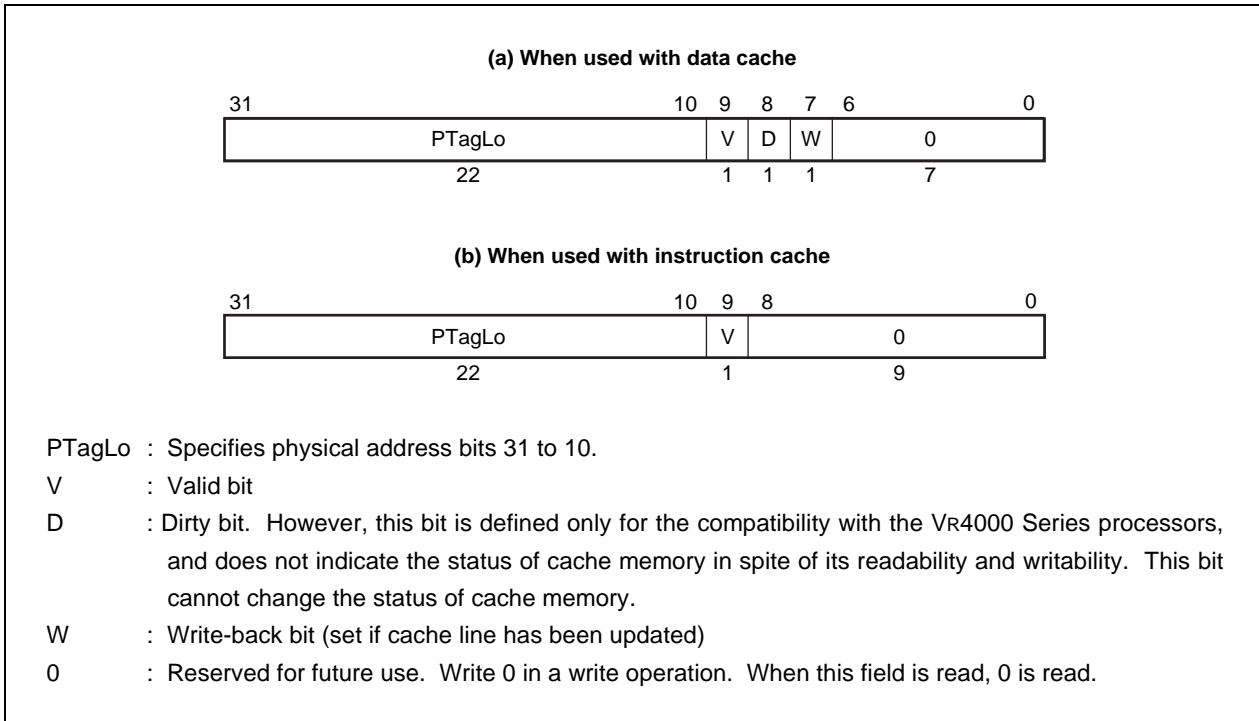
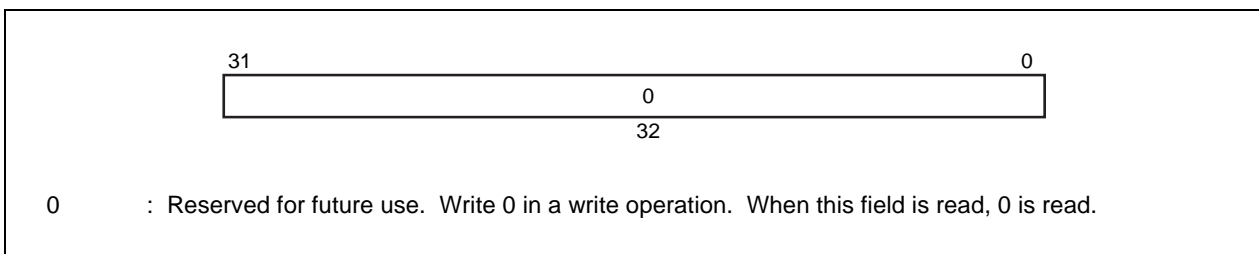

Figure 6-22. TagHi Register



6.5.11 Virtual-to-physical address translation

During virtual-to-physical address translation, the CPU compares the 8-bit ASID (when the Global bit, G, is not set to 1) of the virtual address to the ASID of the TLB entry to see if there is a match. One of the following comparisons are also made:

- In 32-bit mode, the high-order bits^{Note} of the 32-bit virtual address are compared to the contents of the VPN2 (virtual page number divided by two) of each TLB entry.
- In 64-bit mode, the high-order bits^{Note} of the 64-bit virtual address are compared to the contents of the VPN2 (virtual page number divided by two) of each TLB entry.

If a TLB entry matches, the physical address and access control bits (C, D, and V) are retrieved from the matching TLB entry. While the V bit of the entry must be set to 1 for a valid address translation to take place, it is not involved in the determination of a matching TLB entry.

Figure 6-23 illustrates the TLB address translation flow.

Note The number of bits differs from page sizes. The table below shows the examples of high-order bits of the virtual address in page size of 256 Kbytes and 1 Kbytes.

Page size \ Mode	256 Kbytes	1 Kbytes
32-bit mode	bits 31 to 19	bits 31 to 11
64-bit mode	bits 63, 62, 39 to 19	bits 63, 62, 39 to 11

Figure 6-23. TLB Address Translation

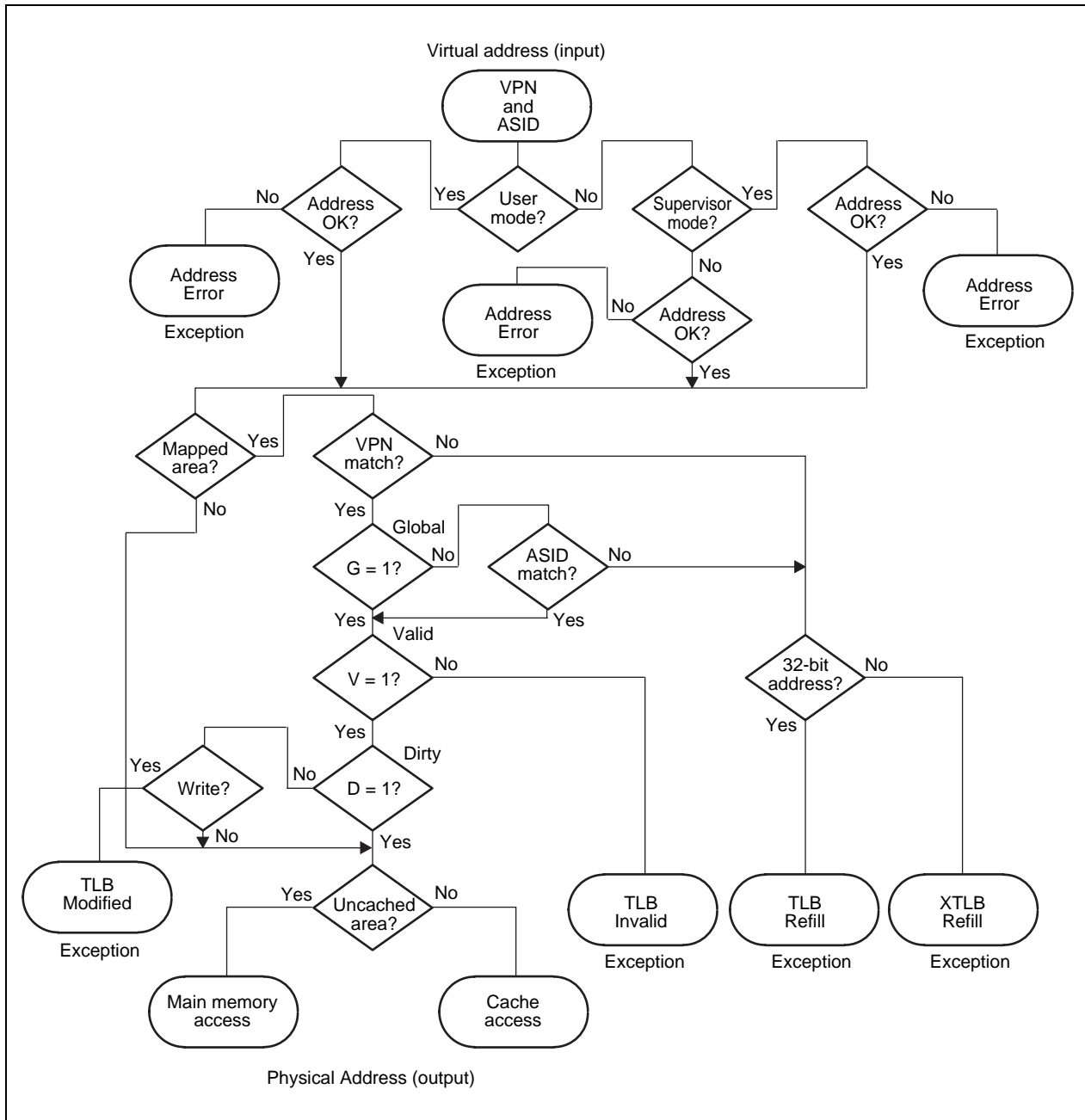

6.5.12 TLB misses

If there is no TLB entry that matches the virtual address, a TLB Refill (miss) exception occurs^{Note}. If the access control bits (D and V) indicate that the access is not valid, a TLB Modified or TLB Invalid exception occurs. If the C bit is 010, the retrieved physical address directly accesses main memory, bypassing the cache.

Note See Chapter 7 for details of the TLB Miss exception.

6.5.13 TLB instructions

The instructions used for TLB control are described below.

(1) Translation lookaside buffer probe (TLBP)

The translation lookaside buffer probe (TLBP) instruction loads the Index register with a TLB number that matches the content of the EntryHi register. If there is no TLB number that matches the TLB entry, the highest-order bit of the Index register is set.

(2) Translation lookaside buffer read (TLBR)

The translation lookaside buffer read (TLBR) instruction loads the EntryHi, EntryLo0, EntryLo1, and PageMask registers with the content of the TLB entry indicated by the content of the Index register.

(3) Translation lookaside buffer write index (TLBWI)

The translation lookaside buffer write index (TLBWI) instruction writes the contents of the EntryHi, EntryLo0, EntryLo1, and PageMask registers to the TLB entry indicated by the content of the Index register.

(4) Translation lookaside buffer write random (TLBWR)

The translation lookaside buffer write random (TLBWR) instruction writes the contents of the EntryHi, EntryLo0, EntryLo1, and PageMask registers to the TLB entry indicated by the content of the Random register.

[MEMO]

CHAPTER 7 EXCEPTION PROCESSING

This chapter describes CPU exception processing, including an explanation of hardware that processes exceptions, followed by the format and use of each CPU exception register.

7.1 Exception Processing Operation

The processor receives exceptions from a number of sources, including translation lookaside buffer (TLB) misses, arithmetic overflows, I/O interrupts, and system calls. When the CPU detects an exception, the normal sequence of instruction execution is suspended and the processor enters Kernel mode (see Chapter 6 for a description of system operating modes). If an exception occurs while executing a MIPS16 instruction, the processor stops the MIPS16 instruction execution, and shifts to the 32-bit instruction execution mode.

The processor then disables interrupts and transfers control for execution to the exception handler (located at a specific address as an exception handling routine implemented by software). The handler saves the context of the processor, including the contents of the program counter, the current operating mode (User or Supervisor), statuses, and interrupt enabling. This context is saved so it can be restored when the exception has been serviced.

When an exception occurs, the CPU loads the Exception Program Counter (EPC) register with a location where execution can restart after the exception has been serviced. The restart location in the EPC register is the address of the instruction that caused the exception or, if the instruction was executing in a branch delay slot, the address of the branch instruction immediately preceding the delay slot. Note that no branch delay slot generated by executing a branch instruction exists when the processor operates in the MIPS16 mode.

When MIPS16 instructions are enabled to be executed, bit 0 of the EPC register indicates the operating mode in which an exception occurred. It indicates 1 when in the MIPS16 instruction mode, and indicates 0 when in the MIPS III instruction mode.

The VR4181 processor supports a Supervisor mode and fast TLB refill for all address spaces. The VR4181 also provides the following functions:

- Interrupt enable (IE) bit
- Operating mode (User, Supervisor, or Kernel)
- Exception level (normal or exception is indicated by the EXL bit in the Status register)
- Error level (normal or error is indicated by the ERL bit in the Status register).

Interrupts are enabled when the following conditions are satisfied:

(1) Interrupt enable

An interrupt is enabled when the following conditions are satisfied.

- Interrupt enable bit (IE) = 1
- EXL bit = 0, ERL bit = 0
- Corresponding IM field bits in the Status register = 1

(2) Operating mode

The operating mode is specified by KSU bit in the Status register when both the exception level and error level are normal (0). The operation enters Kernel mode when either EXL bit or ERL bit in the Status register is set to 1.

(3) Exception/error levels

Returning from an exception resets the exception level to normal (0) (for details, see Chapter 27).

The registers that retain address, cause, and status information during exception processing are described in **7.3 Exception Processing Registers**. For a description of the exception process, see **7.4 Details of Exceptions**.

7.2 Precision of Exceptions

VR4181 exceptions are logically precise; the instruction that causes an exception and all those that follow it are aborted and can be re-executed after servicing the exception. When succeeding instructions are killed, exceptions associated with those instructions are also killed. Exceptions are not taken in the order detected, but in instruction fetch order.

The exception handler can still determine exception and its origin. The cause of the program can be restarted by rewriting the destination register - not automatically, however, as in the case of all the other precise exceptions where no status change occurs.

7.3 Exception Processing Registers

This section describes the CP0 registers that are used in exception processing. Table 7-1 lists these registers, along with their number—each register has a unique identification number that is referred to as its register number. The CP0 registers not listed in the table are used in memory management (see Chapter 6 for details).

The exception handler examines the CP0 registers during exception processing to determine the cause of the exception and the state of the CPU at the time the exception occurred.

The registers in Table 7-1 are used in exception processing, and are described in the sections that follow.

Table 7-1. CP0 Exception Processing Registers

Register name	Register number
Context register	4
BadVAddr register	8
Count register	9
Compare register	11
Status register	12
Cause register	13
EPC register	14
WatchLo register	18
WatchHi register	19
XContext register	20
Parity Error register ^{Note}	26
Cache Error register ^{Note}	27
ErrorEPC register	30

Note This register is prepared to maintain compatibility with the Vr4100. This register is not used in the Vr4181 hardware.

7.3.1 Context register (4)

The Context register is a read/write register containing the pointer to an entry in the page table entry (PTE) array on the memory; this array is a table that stores virtual-to-physical address translations. When there is a TLB miss, the operating system loads the unsuccessfully translated entry from the PTE array to the TLB. The Context register is used by the TLB Refill exception handler for loading TLB entries. The Context register duplicates some of the information provided in the BadVAddr register, but the information is arranged in a form that is more useful for a software TLB exception handler. Figure 7-1 shows the format of the Context register.

Figure 7-1. Context Register Format

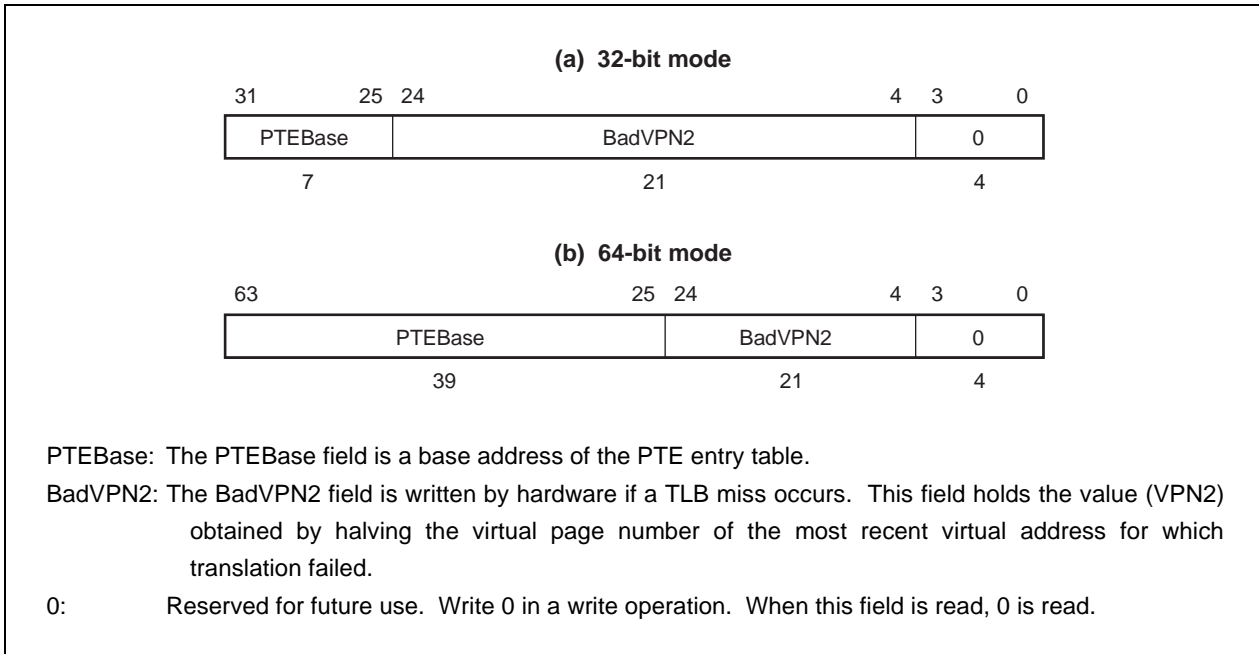

The PTEBase field is used by software as the pointer to the base address of the PTE table in the current user address space.

The 21-bit BadVPN2 field contains bits 31 to 11 of the virtual address that caused the TLB miss; bit 10 is excluded because a single TLB entry maps to an even-odd page pair. For a 1-Kbyte page size, this format can directly address the pair-table of 8-byte PTEs. When the page size is 4 Kbytes or more, shifting or masking this value produces the correct PTE reference address.

7.3.2 BadVAddr register (8)

The Bad Virtual Address (BadVAddr) register is a read-only register that saves the most recent virtual address that failed to have a valid translation, or that had an addressing error. Figure 7-2 shows the format of the BadVAddr register.

Caution This register saves no information after a bus error exception, because it is not an address error exception.

Figure 7-2. BadVAddr Register Format

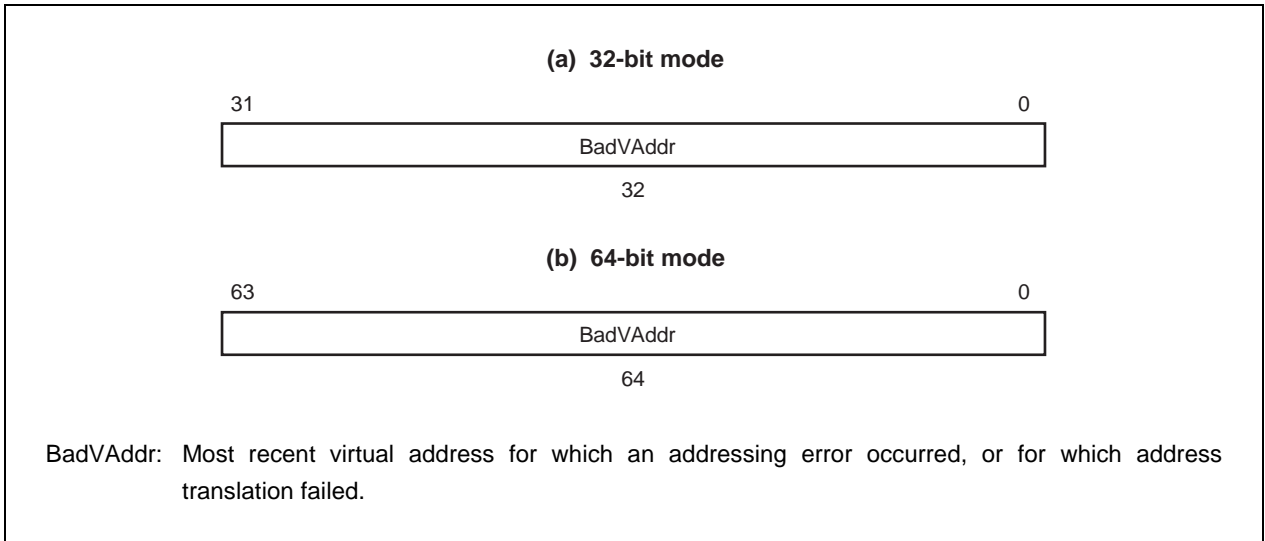

7.3.3 Count register (9)

The read/write Count register acts as a timer. It is incremented in synchronization with the MasterOut clock (1/8, 1/12, or 1/16 frequencies of the PClock), regardless of whether instructions are being executed, retired, or any forward progress is actually made through the pipeline.

This register is a free-running type. When the register reaches all ones, it rolls over to zero and continues counting. This register is used for self-diagnostic test, system initialization, or the establishment of inter-process synchronization.

Figure 7-3 shows the format of the Count register.

Figure 7-3. Count Register Format

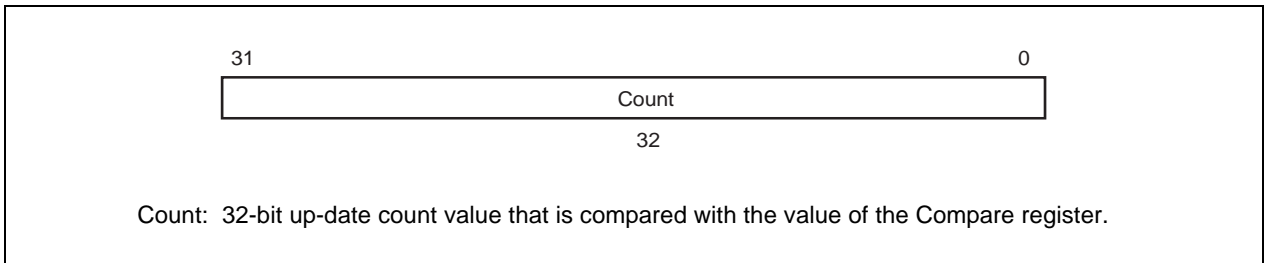

7.3.4 Compare register (11)

The Compare register causes a timer interrupt; it maintains a stable value that does not change on its own.

When the value of the Count register (see **7.3.3 Count register (9)**) equals the value of the Compare register, the IP(7) bit in the Cause register is set. This causes an interrupt as soon as the interrupt is enabled.

Writing a value to the Compare register, as a side effect, clears the timer interrupt request.

For diagnostic purposes, the Compare register is a read/write register. Normally, this register should be only used for a write. Figure 7-4 shows the format of the Compare register.

Figure 7-4. Compare Register Format

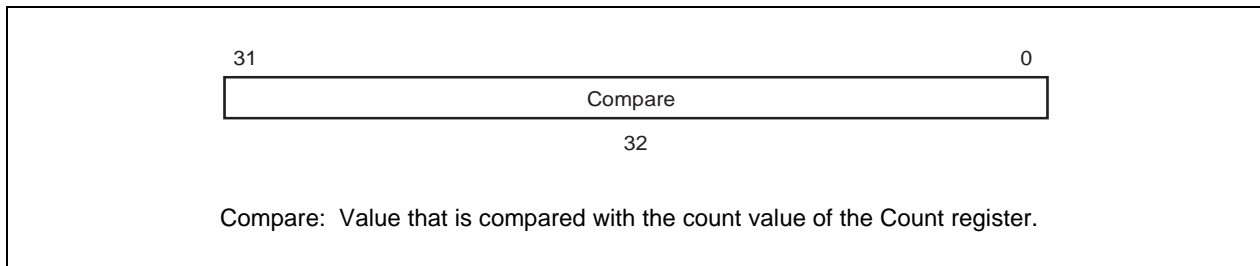

7.3.5 Status register (12)

The Status register is a read/write register that contains the operating mode, interrupt enabling, and the diagnostic states of the processor. Figure 7-5 shows the format of the Status register.

Figure 7-5. Status Register Format (1/2)

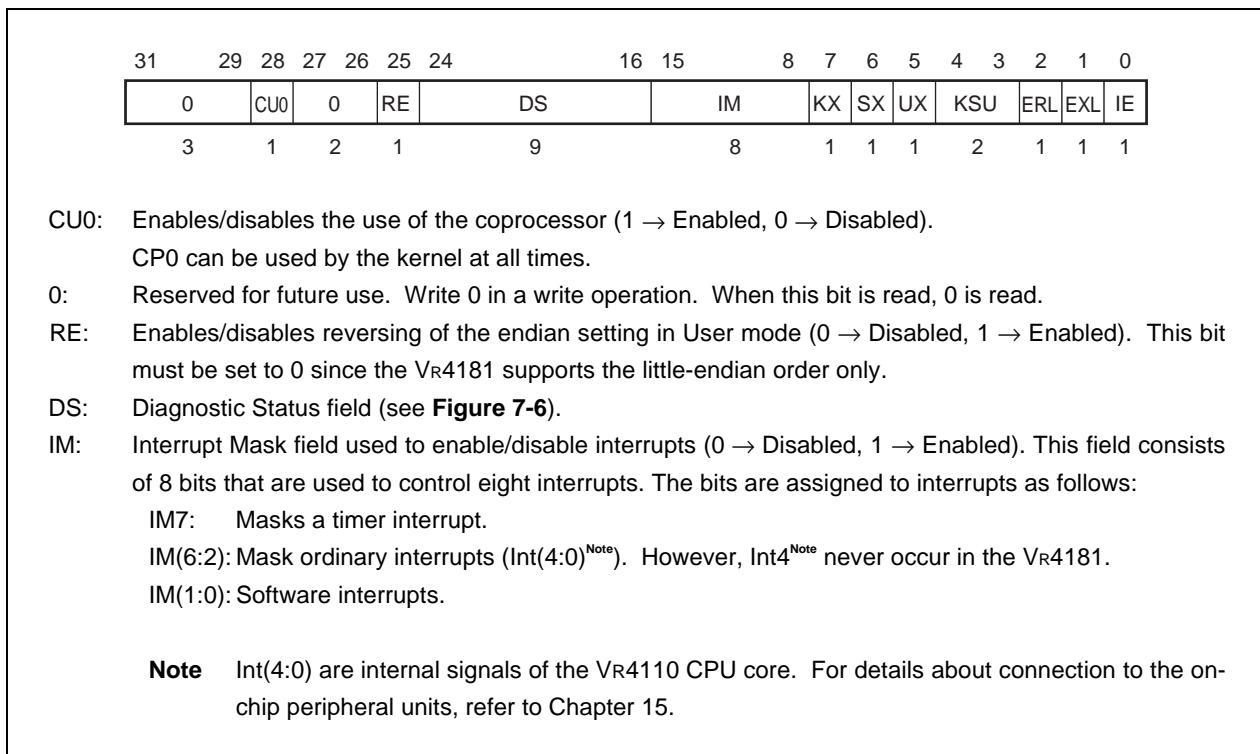

Figure 7-5. Status Register Format (2/2)

KX:	Enables 64-bit addressing in Kernel mode (0 → 32-bit, 1 → 64-bit). If this bit is set, an XTLB Refill exception occurs if a TLB miss occurs in the Kernel mode address space.
SX:	Enables 64-bit addressing and operation in Supervisor mode (0 → 32-bit, 1 → 64-bit). If this bit is set, an XTLB Refill exception occurs if a TLB miss occurs in the Supervisor mode address space.
UX:	Enables 64-bit addressing and operation in User mode (0 → 32-bit, 1 → 64-bit). If this bit is set, an XTLB Refill exception occurs if a TLB miss occurs in the User mode address space.
KSU:	Sets and indicates the operating mode (10 → User, 01 → Supervisor, 00 → Kernel).
ERL:	Sets and indicates the error level (0 → Normal, 1 → Error).
EXL:	Sets and indicates the exception level (0 → Normal, 1 → Exception).
IE:	Sets and indicates interrupt enabling/disabling (0 → Disabled, 1 → Enabled).

Figure 7-6 shows the details of the Diagnostic Status (DS) field. All DS field bits other than the TS bit are writable.

Figure 7-6. Status Register Diagnostic Status Field

24	23	22	21	20	19	18	17	16
0	BEV	TS	SR	0	CH	CE	DE	
2	1	1	1	1	1	1	1	

BEV:	Specifies the base address of a TLB Refill exception vector and common exception vector (0 → Normal, 1 → Bootstrap).
TS:	Occurs the TLB to be shut down (read-only) (0 → Not shut down, 1 → Shut down). This bit is used to avoid any problems that may occur when multiple TLB entries match the same virtual address. After the TLB has been shut down, reset the processor to enable restart. Note that the TLB is shut down even if a TLB entry matching a virtual address is marked as being invalid (with the V bit cleared).
SR:	Occurs a Soft Reset or NMI exception (0 → Not occurred, 1 → Occurred).
CH:	CP0 condition bit (0 → False, 1 → True). This bit can be read and written by software only; it cannot be accessed by hardware.
CE, DE:	These are prepared to maintain compatibility with the Vr4100, and are not used in the Vr4181 hardware.
0:	Reserved for future use. Write 0 in a write operation. When this field is read, 0 is read.

The status register has the following fields where the modes and access status are set.

(1) Interrupt enable

Interrupts are enabled when all of the following conditions are true:

- IE is set to 1.
- EXL is cleared to 0.
- ERL is cleared to 0.
- The appropriate bit of the IM is set to 1.

(2) Operating modes

The following Status register bit settings are required for User, Kernel, and Supervisor modes.

- The processor is in User mode when KSU = 10, EXL = 0, and ERL = 0.
- The processor is in Supervisor mode when KSU = 01, EXL = 0, and ERL = 0.
- The processor is in Kernel mode when KSU = 00, EXL = 1, or ERL = 1.

(3) 32- and 64-bit modes

The following Status register bit settings select 32- or 64-bit operation for User, Kernel, and Supervisor operating modes. Enabling 64-bit operation permits the execution of 64-bit opcodes and translation of 64-bit addresses. 64-bit operation for User, Kernel and Supervisor modes can be set independently.

- 64-bit addressing for Kernel mode is enabled when KX bit = 1. 64-bit operations are always valid in Kernel mode.
- 64-bit addressing and operations are enabled for Supervisor mode when SX bit = 1.
- 64-bit addressing and operations are enabled for User mode when UX bit = 1.

(4) Kernel address space accesses

Access to the kernel address space is allowed when the processor is in Kernel mode.

(5) Supervisor address space accesses

Access to the supervisor address space is allowed when the processor is in Supervisor or Kernel mode.

(6) User address space accesses

Access to the user address space is allowed in any of the three operating modes.

(7) Status after reset

The contents of the Status register are undefined after Cold resets, except for the following bits in the diagnostic status field.

- TS and SR are cleared to 0.
- ERL and BEV are set to 1.
- SR is 0 after Cold reset, and is 1 after Soft reset or NMI interrupt.

Remark Cold reset and Soft reset are CPU core reset (see **8.4 Reset of CPU Core**). For the reset of all the V_R4181 including peripheral units, refer to **CHAPTER 8 INITIALIZATION INTERFACE** and **CHAPTER 15 POWER MANAGEMENT UNIT (PMU)**.

7.3.6 Cause register (13)

The 32-bit read/write Cause register holds the cause of the most recent exception. A 5-bit exception code indicates one of the causes (see **Table 7-2**). Other bits holds the detailed information of the specific exception. All bits in the Cause register, with the exception of the IP1 and IP0 bits, are read-only; IP1 and IP0 are used for software interrupts. Figure 7-7 shows the fields of this register; Table 7-2 describes the Cause register codes.

Figure 7-7. Cause Register Format

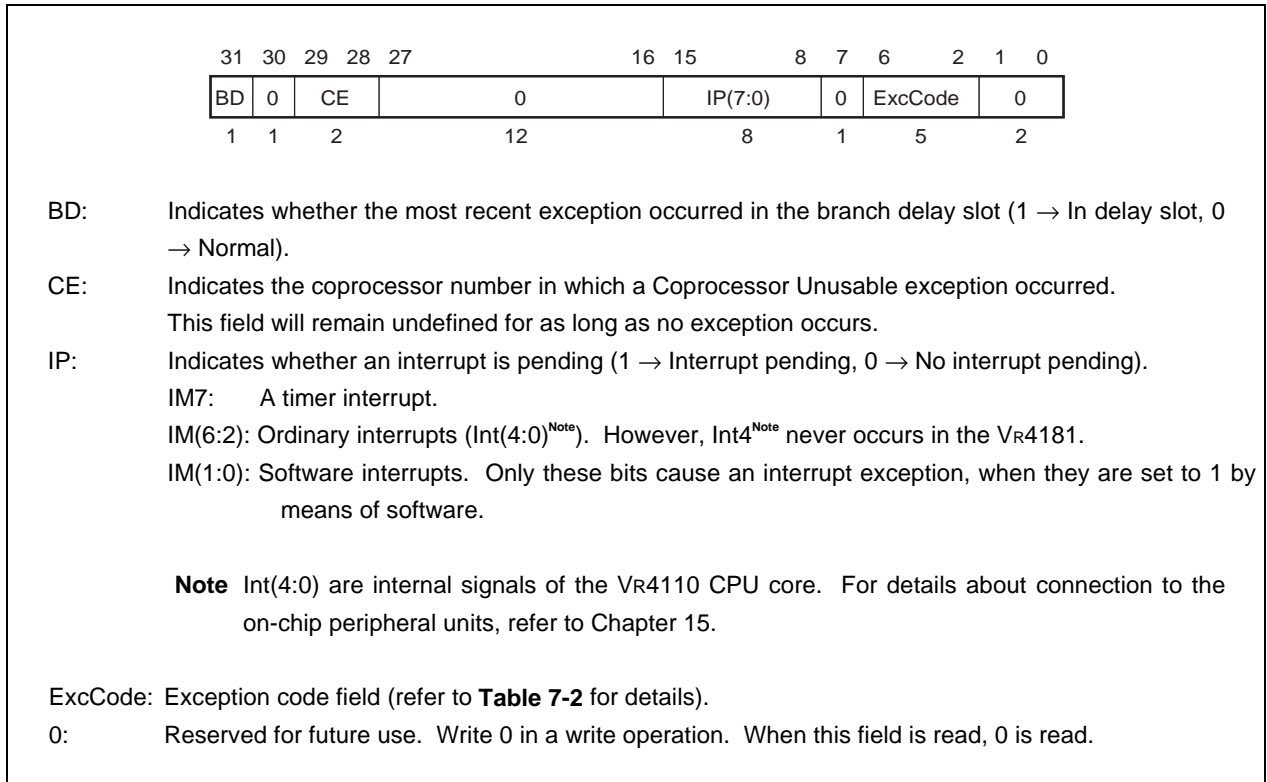

Table 7-2. Cause Register Exception Code Field

Exception code	Mnemonic	Description
0	Int	Interrupt exception
1	Mod	TLB Modified exception
2	TLBL	TLB Refill exception (load or fetch)
3	TLBS	TLB Refill exception (store)
4	AdEL	Address Error exception (load or fetch)
5	AdES	Address Error exception (store)
6	IBE	Bus Error exception (instruction fetch)
7	DBE	Bus Error exception (data load or store)
8	Sys	System Call exception
9	Bp	Breakpoint exception
10	RI	Reserved Instruction exception
11	CpU	Coprocessor Unusable exception
12	Ov	Integer Overflow exception
13	Tr	Trap exception
14 to 22	—	Reserved for future use
23	WATCH	Watch exception
24 to 31	—	Reserved for future use

The V_R4181 has eight interrupt request sources, IP7 to IP0.

For the detailed description of interrupts, refer to Chapter 10.

(1) IP7

This bit indicates whether there is a timer interrupt request.

It is set when the values of Count register and Compare register match.

(2) IP6 to IP2

IP6 to IP2 reflect the state of the interrupt request signal of the CPU core.

(3) IP1 and IP0

These bits are used to set/clear a software interrupt request.

7.3.7 Exception program counter (EPC) register (14)

The Exception Program Counter (EPC) is a read/write register that contains the address at which processing resumes after an exception has been serviced. The contents of this register change depending on whether execution of MIPS16 instructions is enabled or disabled. Setting the MIPS16EN pin after RTC reset specifies whether execution of the MIPS16 instructions is enabled or disabled.

When the MIPS16 instruction execution is disabled, the EPC register contains either:

- Virtual address of the instruction that caused the exception.
- Virtual address of the immediately preceding branch or jump instruction (when the instruction associated with the exception is in a branch delay slot, and the BD bit in the Cause register is set to 1).

When the MIPS16 instruction execution is enabled, the EPC register contains either:

- Virtual address of the instruction that caused the exception and ISA mode at which an exception occurs.
- Virtual address of the immediately preceding branch or jump instruction and ISA mode at which an exception occurs (when the instruction associated with the exception is in a branch delay slot of the jump instruction, and the BD bit in the Cause register is set to 1).

When the 16-bit instruction is executed, the EPC register contains either:

- Virtual address of the instruction that caused the exception and ISA mode at which an exception occurs.
- Virtual address of the immediately preceding Extend or jump instruction and ISA mode at which an exception occurs (when the instruction associated with the exception is in a branch delay slot of the jump instruction or in the instruction following the Extend instruction, and the BD bit in the Cause register is set to 1).

The EXL bit in the Status register is set to 1 to keep the processor from overwriting the address of the exception-causing instruction contained in the EPC register in the event of another exception.

Figure 7-8 shows the EPC register format when MIPS16 ISA is disabled, and Figure 7-9 shows the EPC register format when MIPS16 ISA is enabled.

Figure 7-8. EPC Register Format (When MIPS16 ISA Is Disabled)

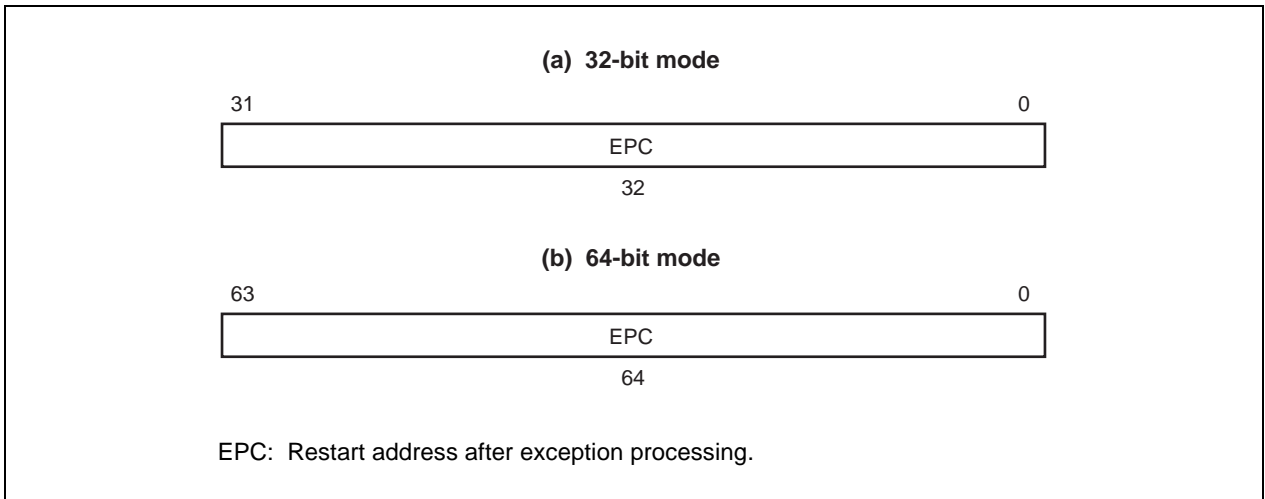
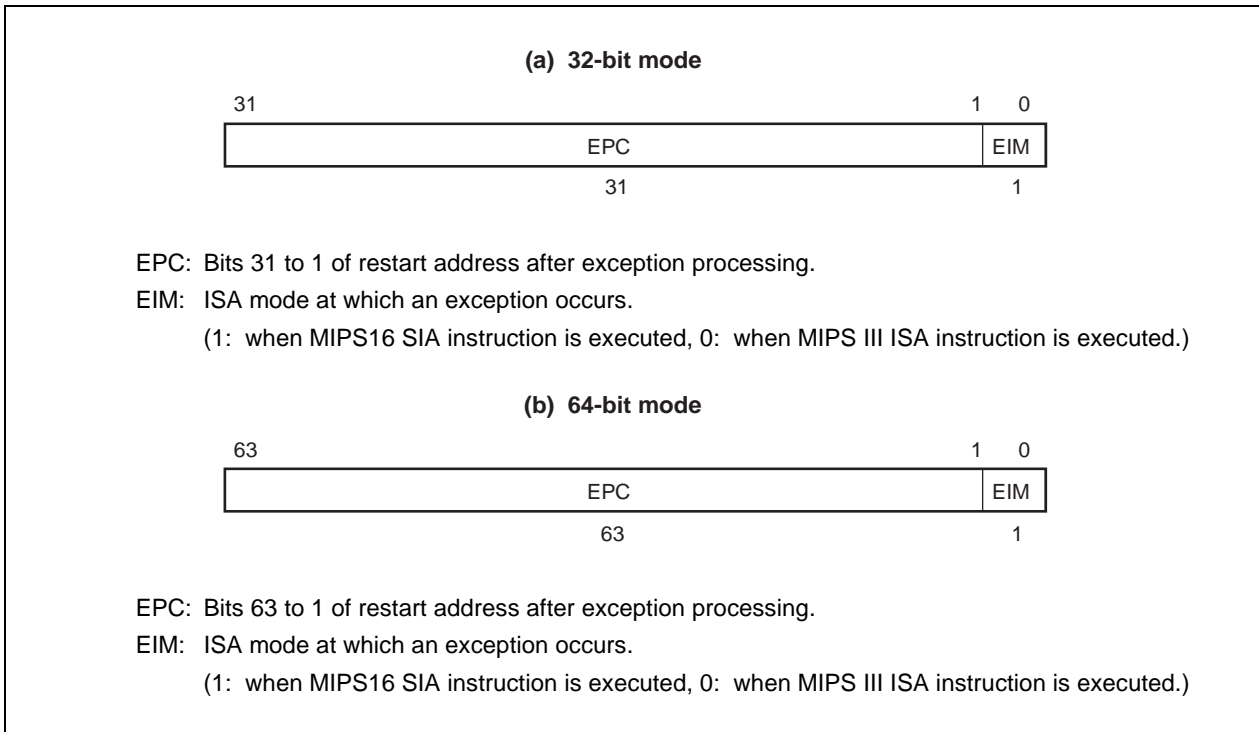

Figure 7-9. EPC Register Format (When MIPS16 ISA Is Enabled)



7.3.8 WatchLo (18) and WatchHi (19) registers

The V_R4181 processor provides a debugging feature to detect references to a selected physical address; load and store instructions to the location specified by the WatchLo and WatchHi registers cause a Watch exception.

Figures 7-10 and 7-11 show the format of the WatchLo and WatchHi registers.

Figure 7-10. WatchLo Register Format

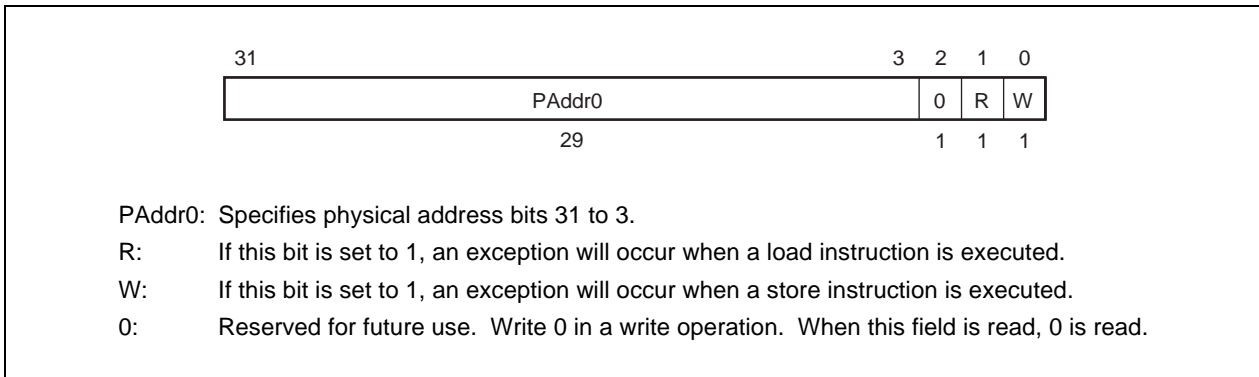
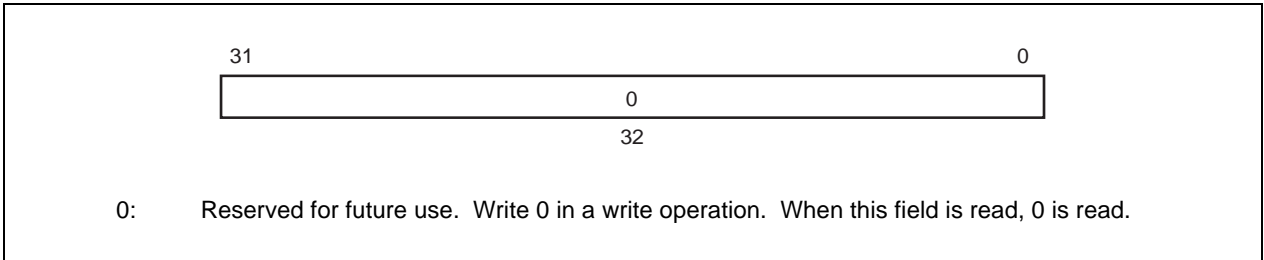

Figure 7-11. WatchHi Register Format



7.3.9 XContext register (20)

The read/write XContext register contains a pointer to an entry in the page table entry (PTE) array, an operating system data structure that stores virtual-to-physical address translations. If a TLB miss occurs, the operating system loads the untranslated data from the PTE into the TLB to handle the software error.

The XContext register is used by the XTLB Refill exception handler to load TLB entries in 64-bit addressing mode.

The XContext register duplicates some of the information provided in the BadVAddr register, and puts it in a form useful for the XTLB exception handler.

This register is included solely for operating system use. The operating system sets the PTEBase field in the register, as needed. Figure 7-12 shows the format of the XContext register.

Figure 7-12. XContext Register Format

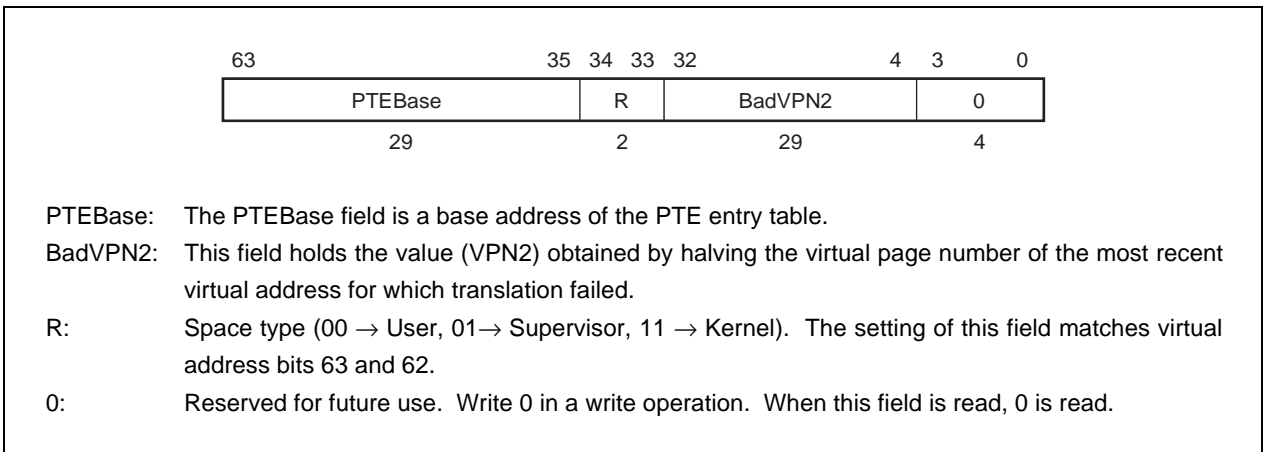

The 29-bit BadVPN2 field has bits 39 to 11 of the virtual address that caused the TLB miss; bit 10 is excluded because a single TLB entry maps to an even-odd page pair. For a 1-Kbyte page size, this format may be used directly to address the pair-table of 8-byte PTEs. For 4-Kbyte-or-more page and PTE sizes, shifting or masking this value produces the appropriate address.

7.3.10 Parity Error register (26)

The Parity Error (PErr) register is a readable/writable register. This register is defined to maintain software-compatibility with the VR4100, and is not used in hardware because the VR4181 has no parity.

Figure 7-13 shows the format of the PErr register.

Figure 7-13. Parity Error Register Format

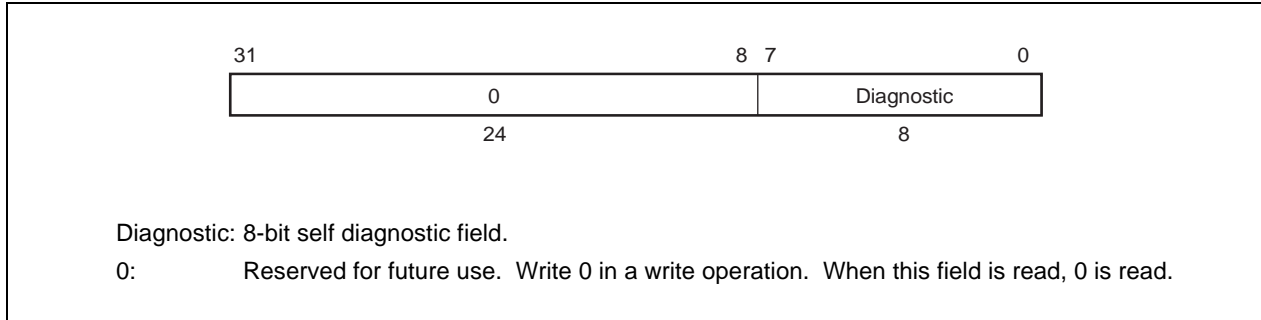

7.3.11 Cache Error register (27)

The Cache Error register is a readable/writable register. This register is defined to maintain software-compatibility with the VR4100, and is not used in hardware because the VR4181 has no parity.

Figure 7-14 shows the format of the Cache Error register.

Figure 7-14. Cache Error Register Format

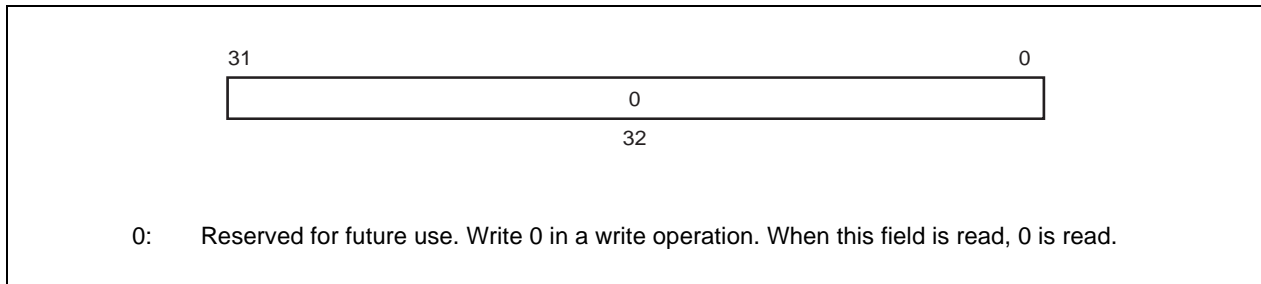

7.3.12 ErrorEPC register (30)

The Error Exception Program Counter (ErrorEPC) register is similar to the EPC register. It is used to store the Program Counter value at which the Cache Error, Cold Reset, Soft Reset, or NMI exception has been serviced.

The read/write ErrorEPC register contains the virtual address at which instruction processing can resume after servicing an error. The contents of this register change depending on whether execution of MIPS16 instructions is enabled or disabled. Setting the MIPS16EN pin after RTC reset specifies whether the execution of MIPS16 instructions is enabled or disabled.

When the MIPS16 ISA is disabled, this address can be:

- Virtual address of the instruction that caused the exception.
- Virtual address of the immediately preceding branch or jump instruction, when the instruction associated with the error exception is in a branch delay slot.

When the MIPS16 instruction execution is enabled during a 32-bit instruction execution, this address can be:

- Virtual address of the instruction that caused the exception and ISA mode at which an exception occurs.
- Virtual address of the immediately preceding branch or jump instruction and ISA mode at which an exception occurs when the instruction associated with the exception is in a branch delay slot.

When the MIPS16 instruction execution is enabled during a 16-bit instruction execution, this address can be:

- Virtual address of the instruction that caused the exception and ISA mode at which an exception occurs.
- Virtual address of the immediately preceding jump instruction or Extend instruction and ISA mode at which an exception occurs when the instruction associated with the exception is in a branch delay slot of the jump instruction or is the instruction following the Extend instruction.

The contents of the ErrorEPC register do not change when the ERL bit of the Status register is set to 1. This prevents the processor when other exceptions occur from overwriting the address of the instruction in this register which causes an error exception.

There is no branch delay slot indication for the ErrorEPC register.

Figure 7-15 shows the format of the ErrorEPC register when the MIPS16ISA is disabled. Figure 7-16 shows the format of the ErrorEPC register when the MIPS16ISA is enabled.

Figure 7-15. ErrorEPC Register Format (When MIPS16 ISA Is Disabled)

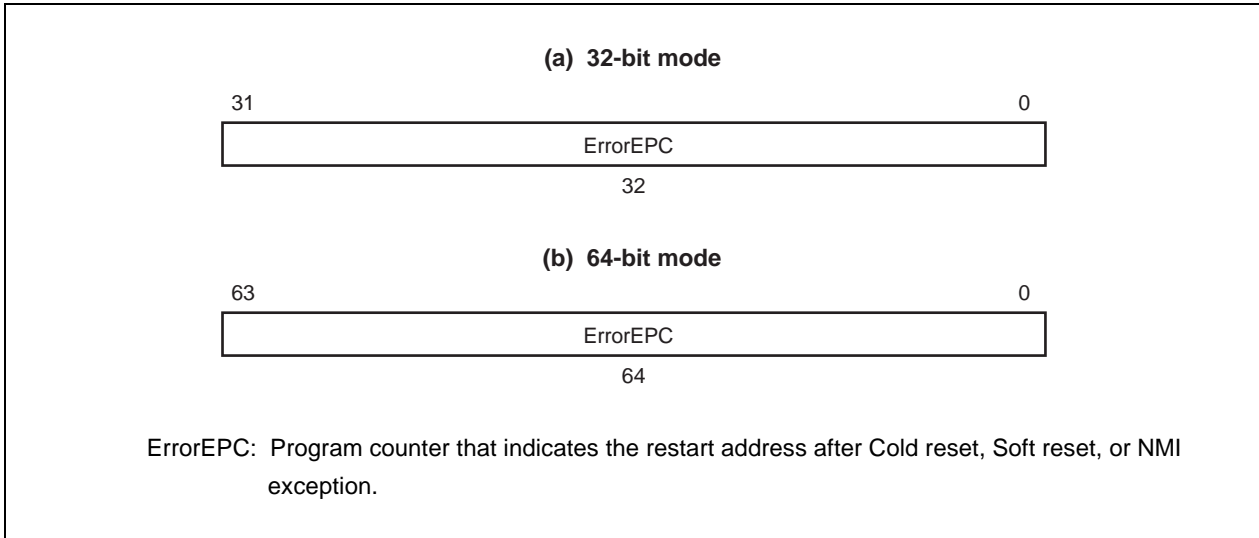
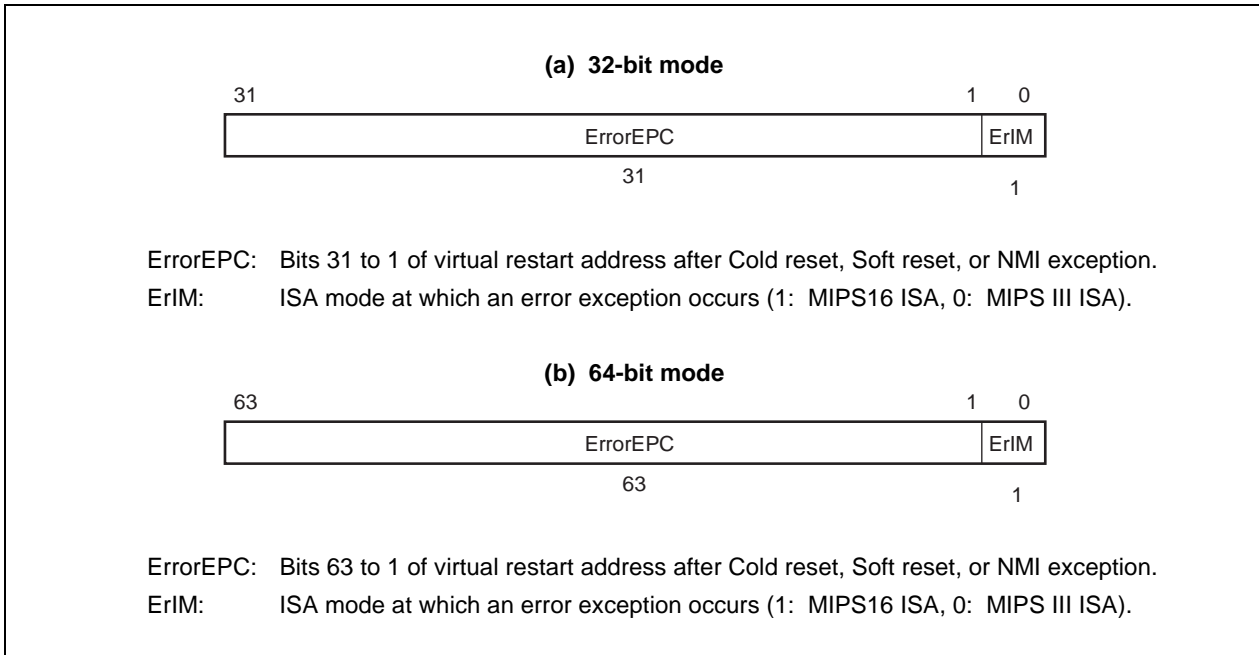

Figure 7-16. ErrorEPC Register Format (When MIPS16 ISA Is Enabled)



7.4 Details of Exceptions

This section describes causes, processes, and services of the VR4181's exceptions.

7.4.1 Exception types

This section gives sample exception handler operations for the following exception types:

- Cold Reset
- Soft Reset
- NMI
- Remaining processor exceptions

When the EXL and ERL bits in the Status register are 0, either User, Supervisor, or Kernel operating mode is specified by the KSU bits in the Status register. When either the EXL or ERL bit is set to 1, the processor is in Kernel mode.

When the processor takes an exception, the EXL bit is set to 1, meaning the system is in Kernel mode. After saving the appropriate state, the exception handler typically resets the EXL bit back to 0. The exception handler sets the EXL bit to 1 so that the saved state is not lost upon the occurrence of another exception while the saved state is being restored.

Returning from an exception also resets the EXL bit to 0. For details, see **CHAPTER 27 MIPS III INSTRUCTION SET DETAILS**.

7.4.2 Exception vector locations

The Cold Reset, Soft Reset, and NMI exceptions are always branched to the following reset exception vector address (virtual). This address is in an uncached, unmapped space.

- 0xBFC0 0000 in 32-bit mode
- 0xFFFF FFFF BFC0 0000 in 64-bit mode

Addresses for the remaining exceptions are a combination of a vector offset and a base address.

64-/32-bit mode exception vectors and their offsets are shown below.

Table 7-3. 64-Bit Mode Exception Vector Base Addresses

	Vector base address (virtual)	Vector offset
Cold Reset Soft Reset NMI	0xFFFF FFFF BFC0 0000 (BEV is automatically set to 1)	0x0000
TLB Refill (EXL = 0)	0xFFFF FFFF 8000 0000 (BEV = 0)	0x0000
XTLB Refill (EXL = 0)	0xFFFF FFFF BFC0 0200 (BEV = 1)	0x0080
Other exceptions		0x0180

Table 7-4. 32-Bit Mode Exception Vector Base Addresses

	Vector base address (virtual)	Vector offset
Cold Reset Soft Reset NMI	0xBFC0 0000 (BEV is automatically set to 1)	0x0000
TLB Refill (EXL = 0)	0x8000 0000 (BEV = 0)	0x0000
XTLB Refill (EXL = 0)	0xBFC0 0200 (BEV = 1)	0x0080
Other exceptions		0x0180

(1) TLB Refill exception vector

When BEV bit = 0, the vector base address (virtual) for the TLB Refill exception is in kseg0 (unmapped) space.

- 0x8000 0000 in 32-bit mode
- 0xFFFF FFFF 8000 0000 in 64-bit mode

When BEV bit = 1, the vector base address (virtual) for the TLB Refill exception is in kseg1 (uncached, unmapped) space.

- 0xBFC0 0200 in 32-bit mode
- 0xFFFF FFFF BFC0 0200 in 64-bit mode

This is an uncached, non-TLB-mapped space, allowing the exception handler to bypass the cache and TLB.

7.4.3 Priority of exceptions

While more than one exception can occur for a single instruction, only the exception with the highest priority is reported. Table 7-5 lists the priorities.

Table 7-5. Exception Priority Order

Priority	Exceptions
High	Cold Reset
↑	Soft Reset
	NMI
	Address Error (instruction fetch)
	TLB/XTLB Refill (instruction fetch)
	TLB Invalid (instruction fetch)
	Bus Error (instruction fetch)
	System Call
	Breakpoint
	Coprocessor Unusable
	Reserved Instruction
	Trap
	Integer Overflow
	Address Error (data access)
	TLB/XTLB Refill (data access)
	TLB Invalid (data access)
	TLB Modified (data write)
	Watch
↓	Bus Error (data access)
Low	Interrupt (other than NMI)

Hereafter, handling exceptions by hardware is referred to as “process”, and handling exception by software is referred to as “service”.

7.4.4 Cold Reset exception

Cause

The Cold Reset exception occurs when the ColdReset# signal (internal) is asserted and then deasserted. This exception is not maskable. The Reset# signal (internal) must be asserted along with the ColdReset# signal (for details, see Chapter 8).

Processing

The CPU provides a special interrupt vector for this exception:

- 0xBFC0 0000 (virtual) in 32-bit mode
- 0xFFFF FFFF BFC0 0000 (virtual) in 64-bit mode

The Cold Reset vector resides in unmapped and uncached CPU address space, so the hardware need not initialize the TLB or the cache to process this exception. It also means the processor can fetch and execute instructions while the caches and virtual memory are in an undefined state.

The contents of all registers in the CPU are undefined when this exception occurs, except for the following register fields:

- When the MIPS16 instruction execution is disabled while the ERL of Status register is 0, the PC value at which an exception occurs is set to the ErrorEPC register.
When the MIPS16 instruction execution is enabled while the ERL of Status register is 0, the PC value at which an exception occurs is set to the ErrorEPC register and the ISA mode in which an exception occurs is set to the least significant bit of the ErrorEPC register.
- TS and SR of the Status register are cleared to 0.
- ERL and BEV of the Status register are set to 1.
- The Random register is initialized to the value of its upper bound (31).
- The Wired register is initialized to 0.
- Bits 31 to 28 and bits 22 to 3 of the Config register are set to fixed values.
- All other bits are undefined.

Servicing

The Cold Reset exception is serviced by:

- Initializing all processor registers, coprocessor registers, TLB, caches, and the memory system
- Performing diagnostic tests
- Bootstrapping the operating system

7.4.5 Soft Reset exception

Cause

A Soft Reset (sometimes called Warm Reset) occurs when the ColdReset# signal remains deasserted while the Reset# signal goes from assertion to deassertion (for details, see Chapter 8).

A Soft Reset immediately resets all state machines, and sets the SR bit of the Status register. Execution begins at the reset vector when the reset is deasserted. This exception is not maskable.

Caution In the Vr4181, a soft reset never occurs.

Processing

The CPU provides a special interrupt vector for this exception (same location as Cold Reset):

- 0xBFC0 0000 (virtual) in 32-bit mode
- 0xFFFF FFFF BFC0 0000 (virtual) in 64-bit mode

This vector is located within unmapped and uncached address space, so that the cache and TLB need not be initialized to process this exception. The SR bit of the Status register is set to 1 to distinguish this exception from a Cold Reset exception.

When this exception occurs, the contents of all registers are preserved except for the following registers:

- When the MIPS16 instruction execution is disabled, the PC value at which an exception occurs is set to the ErrorEPC register.
When the MIPS16 instruction execution is enabled, the PC value at which an exception occurs is set to the ErrorEPC register and the ISA mode in which an exception occurs is set to the least significant bit of the ErrorEPC register.
- TS bit of the Status register is cleared to 0.
- ERL, SR, and BEV bits of the Status register are set to 1.

During a soft reset, access to the operating cache or system interface may be aborted. This means that the contents of the cache and memory will be undefined if a Soft Reset occurs.

Servicing

The Soft Reset exception is serviced by:

- Preserving the current processor states for diagnostic tests
- Reinitializing the system in the same way as for a Cold Reset exception

7.4.6 NMI exception

Cause

The Nonmaskable Interrupt (NMI) exception occurs when the NMI signal (internal) becomes active. This interrupt is not maskable; it occurs regardless of the settings of the EXL, ERL, and the IE bits in the Status register (for details, see Chapters 10 and 15).

Processing

The CPU provides a special interrupt vector for this exception:

- 0xBFC0 0000 (virtual) in 32-bit mode
- 0xFFFF FFFF BFC0 0000 (virtual) in 64-bit mode

This vector is located within unmapped and uncached address space so that the cache and TLB need not be initialized to process an NMI interrupt. The SR bit of the Status register is set to 1 to distinguish this exception from a Cold Reset exception.

Unlike Cold Reset and Soft Reset, but like other exceptions, NMI is taken only at instruction boundaries. The states of the caches and memory system are preserved by this exception.

When this exception occurs, the contents of all registers are preserved except for the following registers:

- When the MIPS16 instruction execution is disabled, the PC value at which an exception occurs is set to the ErrorEPC register.
When the MIPS16 instruction execution is enabled, the PC value at which an exception occurs is set to the ErrorEPC register and the ISA mode in which an exception occurs is set to the least significant bit of the ErrorEPC register.
- The TS bit of the Status register is cleared to 0.
- The ERL, SR, and BEV bits of the Status register are set to 1.

Servicing

The NMI exception is serviced by:

- Preserving the current processor states for diagnostic tests
- Reinitializing the system in the same way as for a Cold Reset exception

7.4.7 Address Error exception

Cause

The Address Error exception occurs when an attempt is made to execute one of the following. This exception is not maskable.

- Execution of the LW, LWU, SW, or CACHE instruction for word data that is not located on a word boundary
- Execution of the LH, LHU, or SH instruction for half-word data that is not located on a half-word boundary
- Execution of the LD or SD instruction for double-word data that is not located on a double-word boundary
- Referencing the kernel address space in User or Supervisor mode
- Referencing the supervisor space in User mode
- Referencing an address that does not exist in the kernel, user, or supervisor address space in 64-bit Kernel, User, or Supervisor mode
- Branching to an address that was not located on a word boundary when the MIPS16 instruction is disabled
- Branching to address whose least-significant 2 bits are 10 when the MIPS16 instruction is enabled

Processing

The common exception vector is used for this exception. The AdEL or AdES code in the Cause register is set. If this exception has been caused by an instruction reference or load operation, AdEL is set. If it has been caused by a store operation, AdES is set.

When this exception occurs, the BadVAddr register stores the virtual address that was not properly aligned or was referenced in protected address space. The contents of the VPN field of the Context and EntryHi registers are undefined, as are the contents of the EntryLo register.

When the MIPS16 instruction is disabled, the EPC register contains the address of the instruction that caused the exception. However, if this instruction is in a branch delay slot, the EPC register contains the address of the preceding jump or branch instruction, and the BD bit of the Cause register is set to 1.

When the MIPS16 instruction is enabled, the EPC register contains the address of the instruction that caused the exception, and the least significant bit stores the ISA mode in which an exception occurs. However, if this instruction is in a branch delay slot or is the instruction following the Extend instruction, the EPC register contains the address of the preceding jump or Extend instruction, and the BD bit of the Cause register is set to 1.

Servicing

The kernel reports the UNIX™ SIGSEGV (segmentation violation) signal to the current process, and this exception is usually fatal.

7.4.8 TLB exceptions

Three types of TLB exceptions can occur:

- TLB Refill exception occurs when there is no TLB entry that matches a referenced address.
- A TLB Invalid exception occurs when a TLB entry that matches a referenced virtual address is marked as being invalid (with the V bit set to 0).
- The TLB Modified exception occurs when a TLB entry that matches a virtual address referenced by the store instruction is marked as being valid (with the V bit set to 1).

The following three sections describe these TLB exceptions.

(1) TLB Refill exception (32-bit space mode)/XTLB Refill exception (64-bit space mode)

Cause

The TLB Refill exception occurs when there is no TLB entry to match a reference to a mapped address space. This exception is not maskable.

Processing

There are two special exception vectors for this exception; one for references to 32-bit address spaces, and one for references to 64-bit address spaces. The UX, SX, and KX bits of the Status register determine whether the user, supervisor or kernel address spaces referenced are 32-bit or 64-bit spaces. When the EXL bit of the Status register is set to 0, either of these two special vectors is referenced. When the EXL bit is set to 1, the common exception vector is referenced.

This exception sets the TLBL or TLBS code in the ExcCode field of the Cause register. If this exception has been caused by an instruction reference or load operation, TLBL is set. If it has been caused by a store operation, TLBS is set.

When this exception occurs, the BadVAddr, Context, XContext and EntryHi registers hold the virtual address that failed address translation. The EntryHi register also contains the ASID from which the translation fault occurred. The Random register normally contains a valid location in which to place the replacement TLB entry. The contents of the EntryLo register are undefined.

When the MIPS16 instruction is disabled, the EPC register contains the address of the instruction that caused the exception. However, if this instruction is in a branch delay slot, the EPC register contains the address of the preceding jump or branch instruction, and the BD bit of the Cause register is set to 1.

When the MIPS16 instruction is enabled, the EPC register contains the address of the instruction that caused the exception, and the least significant bit stores the ISA mode in which an exception occurs. However, if this instruction is in a branch delay slot or is the instruction following the Extend instruction, the EPC register contains the address of the preceding jump or Extend instruction, and the BD bit of the Cause register is set to 1.

Servicing

To service this exception, the contents of the Context or XContext register are used as a virtual address to fetch memory words containing the physical page frame and access control bits for a pair of TLB entries. The memory word is written into the TLB entry by using the EntryLo0, EntryLo1, or EntryHi register.

It is possible that the physical page frame and access control bits are placed in a page where the virtual address is not resident in the TLB. This condition is processed by allowing a TLB Refill exception in the TLB Refill exception handler. In this case, the common exception vector is used because the EXL bit of the Status register is set to 1.

(2) TLB Invalid exception**Cause**

The TLB Invalid exception occurs when the TLB entry that matches with the virtual address to be referenced is invalid (the V bit is set to 0). This exception is not maskable.

Processing

The common exception vector is used for this exception. The TLBL or TLBS code in the ExcCode field of the Cause register is set. If this exception has been caused by an instruction reference or load operation, TLBL is set. If it has been caused by a store operation, TLBS is set.

When this exception occurs, the BadVAddr, Context, Xcontext, and EntryHi registers contain the virtual address that failed address translation. The EntryHi register also contains the ASID from which the translation fault occurred. The Random register normally stores a valid location in which to place the replacement TLB entry. The contents of the EntryLo register are undefined.

When the MIPS16 instruction is disabled, the EPC register contains the address of the instruction that caused the exception. However, if this instruction is in a branch delay slot, the EPC register contains the address of the preceding jump or branch instruction, and the BD bit of the Cause register is set to 1.

When the MIPS16 instruction is enabled, the EPC register contains the address of the instruction that caused the exception, and the least significant bit stores the ISA mode in which an exception occurs. However, if this instruction is in a branch delay slot or is the instruction following the Extend instruction, the EPC register contains the address of the preceding jump or Extend instruction, and the BD bit of the Cause register is set to 1.

Servicing

Usually, the V bit of a TLB entry is cleared in the following cases:

- When a virtual address does not exist
- When the virtual address exists, but is not in main memory (a page fault)
- When a trap is required on any reference to the page (for example, to maintain a reference bit)

After servicing the cause of a TLB Invalid exception, the TLB entry is located with a TLBP (TLB Probe) instruction, and replaced by an entry with its Valid bit set to 1.

(3) TLB Modified exception

Cause

The TLB Modified exception occurs when the TLB entry that matches with the virtual address referenced by the store instruction is valid (bit V is 1) but is not writable (bit D is 0). This exception is not maskable.

Processing

The common exception vector is used for this exception, and the Mod code in the ExcCode field of the Cause register is set.

When this exception occurs, the BadVAddr, Context, Xcontext, and EntryHi registers contain the virtual address that failed address translation. The EntryHi register also contains the ASID from which the translation fault occurred. The contents of the EntryLo register are undefined.

When the MIPS16 instruction is disabled, the EPC register contains the address of the instruction that caused the exception. However, if this instruction is in a branch delay slot, the EPC register contains the address of the preceding jump or branch instruction, and the BD bit of the Cause register is set to 1.

When the MIPS16 instruction is enabled, the EPC register contains the address of the instruction that caused the exception, and the least significant bit stores the ISA mode in which an exception occurs. However, if this instruction is in a branch delay slot or is the instruction following the Extend instruction, the EPC register contains the address of the preceding jump or Extend instruction, and the BD bit of the Cause register is set to 1.

Servicing

The kernel uses the failed virtual address or virtual page number to identify the corresponding access control bits. The page identified may or may not permit write accesses; if writes are not permitted, a write protection violation occurs.

If write accesses are permitted, the page frame is marked dirty (/writable) by the kernel in its own data structures.

The TLBP instruction places the index of the TLB entry that must be altered into the Index register. The word data containing the physical page frame and access control bits (with the D bit set to 1) is loaded to the EntryLo register, and the contents of the EntryHi and EntryLo registers are written into the TLB.

7.4.9 Bus Error exception

Cause

A Bus Error exception is raised by board-level circuitry for events such as bus time-out, local bus parity errors, and invalid physical memory addresses or access types. This exception is not maskable.

A Bus Error exception occurs only when a cache miss refill, uncached reference, or unbuffered write occurs synchronously.

Processing

The common interrupt vector is used for a Bus Error exception. The IBE or DBE code in the ExcCode field of the Cause register is set, signifying whether the instruction caused the exception by an instruction reference, load operation, or store operation.

When the MIPS16 instruction is disabled, the EPC register contains the address of the instruction that caused the exception. However, if this instruction is in a branch delay slot, the EPC register contains the address of the preceding jump or branch instruction, and the BD bit of the Cause register is set to 1.

When the MIPS16 instruction is enabled, the EPC register contains the address of the instruction that caused the exception, and the least significant bit stores the ISA mode in which an exception occurs. However, if this instruction is in a branch delay slot or is the instruction following the Extend instruction, the EPC register contains the address of the preceding jump or Extend instruction, and the BD bit of the Cause register is set to 1.

Servicing

The physical address at which the fault occurred can be computed from information available in the System Control Coprocessor (CP0) registers.

- If the IBE code in the Cause register is set (indicating an instruction fetch), the virtual address is contained in the EPC register (or 4 + the contents of the EPC register if the BD bit of the Cause register is set to 1).
- If the DBE code is set (indicating a load or store), the virtual address of the instruction that caused the exception is saved to the EPC register.

The virtual address of the load and store instruction can then be obtained by interpreting the instruction. The physical address can be obtained by using the TLBP instruction and reading the EntryLo register to compute the physical page number.

At the time of this exception, the kernel reports the UNIX SIGBUS (bus error) signal to the current process, but the exception is usually fatal.

7.4.10 System Call exception

Cause

A System Call exception occurs during an attempt to execute the SYSCALL instruction. This exception is not maskable.

Processing

The common exception vector is used for this exception, and the Sys code in the ExcCode field of the Cause register is set.

The EPC register contains the address of the SYSCALL instruction unless it is in a branch delay slot, in which case the EPC register contains the address of the preceding branch instruction.

If the SYSCALL instruction is in a branch delay slot, the BD bit of the Status register is set to 1; otherwise this bit is cleared.

Servicing

When this exception occurs, control is transferred to the applicable system routine.

To resume execution, the EPC register must be altered so that the SYSCALL instruction does not re-execute; this is accomplished by adding a value of 4 to the EPC register before returning.

If a SYSCALL instruction is in a branch delay slot, interpretation of the branch instruction is required to resume execution.

7.4.11 Breakpoint exception

Cause

A Breakpoint exception occurs when an attempt is made to execute the BREAK instruction. This exception is not maskable.

Processing

The common exception vector is used for this exception, and the BP code in the ExcCode field of the Cause register is set.

When the MIPS16 instruction is disabled, the EPC register contains the address of the instruction that caused the exception. However, if this instruction is in a branch delay slot, the EPC register contains the address of the preceding jump or branch instruction, and the BD bit of the Cause register is set to 1.

When the MIPS16 instruction is enabled, the EPC register contains the address of the instruction that caused the exception, and the least significant bit stores the ISA mode in which an exception occurs. However, if this instruction is in a branch delay slot or is the instruction following the Extend instruction, the EPC register contains the address of the preceding jump or Extend instruction, and the BD bit of the Cause register is set to 1.

Servicing

When the Breakpoint exception occurs, control is transferred to the applicable system routine. Additional distinctions can be made by analyzing the unused bits of the BREAK instruction (bits 25 to 6), and loading the contents of the instruction whose address the EPC register contains. A value of 4 must be added to the contents of the EPC register to locate the instruction if it resides in a branch delay slot.

To resume execution, the EPC register must be altered so that the BREAK instruction does not re-execute; this is accomplished by adding a value of 4 to the EPC register before returning.

When a Breakpoint exception occurs while executing the MIPS16 instruction, a value of 2 should be added to the EPC register before returning.

If a BREAK instruction is in a branch delay slot, interpretation (decoding) of the branch instruction is required to resume execution.

7.4.12 Coprocessor Unusable exception

Cause

The Coprocessor Unusable exception occurs when an attempt is made to execute a coprocessor instruction for either:

- a corresponding coprocessor unit that has not been marked usable (Status register bit, CU[0] = 0), or
- CPO instructions, when the unit has not been marked usable (Status register bit, CU[0] = 0) and the process executes in User or Supervisor mode.

This exception is not maskable.

Processing

The common exception vector is used for this exception, and the CPU code in the ExcCode field of the Cause register is set. The CE bit of the Cause register indicates which of the four coprocessors was referenced.

When the MIPS16 instruction is disabled, the EPC register contains the address of the instruction that caused the exception. However, if this instruction is in a branch delay slot, the EPC register contains the address of the preceding jump or branch instruction, and the BD bit of the Cause register is set to 1.

When the MIPS16 instruction is enabled, the EPC register contains the address of the instruction that caused the exception, and the least significant bit stores the ISA mode in which an exception occurs. However, if this instruction is in a branch delay slot or is the instruction following the Extend instruction, the EPC register contains the address of the preceding jump or Extend instruction, and the BD bit of the Cause register is set to 1.

Servicing

The coprocessor unit to which an attempted reference was made is identified by the CE bit of the Cause register. One of the following processing is performed by the handler:

- If the process is entitled access to the coprocessor, the coprocessor is marked usable and the corresponding state is restored to the coprocessor.
- If the process is entitled access to the coprocessor, but the coprocessor does not exist or has failed, interpretation of the coprocessor instruction is possible.
- If the BD bit in the Cause register is set to 1, the branch instruction must be interpreted; then the coprocessor instruction can be emulated and execution resumed with the EPC register advanced past the coprocessor instruction.
- If the process is not entitled access to the coprocessor, the kernel reports UNIX SIGILL/ILL_PRIVIN_FAULT (illegal instruction/privileged instruction fault) signal to the current process, and this exception is fatal.

7.4.13 Reserved Instruction exception

Cause

The Reserved Instruction exception occurs when an attempt is made to execute one of the following instructions:

- Instruction with an undefined major opcode (bits 31 to 26)
- SPECIAL instruction with an undefined minor opcode (bits 5 to 0)
- REGIMM instruction with an undefined minor opcode (bits 20 to 16)
- 64-bit instructions in 32-bit User or Supervisor mode
- RR instruction with an undefined minor op code (bits 4 to 0) when executing the MIPS16 instruction
- I8 instruction with an undefined minor op code (bits 10 to 8) when executing the MIPS16 instruction

64-bit operations are always valid in Kernel mode regardless of the value of the KX bit in the Status register. This exception is not maskable.

Processing

The common exception vector is used for this exception, and the RI code in the ExcCode field of the Cause register is set.

When the MIPS16 instruction is disabled, the EPC register contains the address of the instruction that caused the exception. However, if this instruction is in a branch delay slot, the EPC register contains the address of the preceding jump or branch instruction, and the BD bit of the Cause register is set to 1.

When the MIPS16 instruction is enabled, the EPC register contains the address of the instruction that caused the exception, and the least significant bit stores the ISA mode in which an exception occurs. However, if this instruction is in a branch delay slot or is the instruction following the Extend instruction, the EPC register contains the address of the preceding jump or Extend instruction, and the BD bit of the Cause register is set to 1.

Servicing

All currently defined MIPS ISA instructions can be executed. The process executing at the time of this exception is handled by a UNIX SIGILL/ILL_RESOP_FAULT (illegal instruction/reserved operand fault) signal. This error is usually fatal.

7.4.14 Trap exception

Cause

The Trap exception occurs when a TGE, TGEU, TLT, TLTU, TEQ, TNE, TGEI, TGEUI, TLTl, TLTUI, TEQI, or TNEI instruction results in a TRUE condition. This exception is not maskable.

Processing

The common exception vector is used for this exception, and the Tr code in the ExcCode field of the Cause register is set.

The EPC register contains the address of the trap instruction causing the exception unless the instruction is in a branch delay slot, in which case the EPC register contains the address of the preceding branch instruction and the BD bit of the Cause register is set to 1.

Servicing

At the time of a Trap exception, the kernel reports the UNIX SIGFPE/FPE_INTOVF_TRAP (floating-point exception/integer overflow) signal to the current process, but the exception is usually fatal.

7.4.15 Integer Overflow exception

Cause

An Integer Overflow exception occurs when an ADD, ADDI, SUB, DADD, DADDI, or DSUB instruction results in a 2's complement overflow. This exception is not maskable.

Processing

The common exception vector is used for this exception, and the Ov code in the ExcCode field of the Cause register is set.

The EPC register contains the address of the instruction that caused the exception unless the instruction is in a branch delay slot, in which case the EPC register contains the address of the preceding branch instruction and the BD bit of the Cause register is set to 1.

Servicing

At the time of the exception, the kernel reports the UNIX SIGFPE/FPE_INTOVF_TRAP (floating-point exception/integer overflow) signal to the current process, and this exception is usually fatal.

7.4.16 Watch exception

Cause

A Watch exception occurs when a load or store instruction references the physical address specified by the WatchLo/WatchHi registers. The WatchLo/WatchHi registers specify whether a load or store or both could have initiated this exception.

- When the R bit of the WatchLo register is set to 1: Load instruction
- When the W bit of the WatchLo register is set to 1: Store instruction
- When both the R bit and W bit of the WatchLo register are set to 1: Load instruction or store instruction

The CACHE instruction never causes a Watch exception.

The Watch exception is postponed while the EXL bit in the Status register is set to 1, and Watch exception is only maskable by setting the EXL bit in the Status register to 1.

Processing

The common exception vector is used for this exception, and the WATCH code in the ExcCode field of the Cause register is set.

When the MIPS16 instruction is disabled, the EPC register contains the address of the instruction that caused the exception. However, if this instruction is in a branch delay slot, the EPC register contains the address of the preceding jump or branch instruction, and the BD bit of the Cause register is set to 1.

When the MIPS16 instruction is enabled, the EPC register contains the address of the instruction that caused the exception, and the least significant bit stores the ISA mode in which an exception occurs. However, if this instruction is in a branch delay slot or is the instruction following the Extend instruction, the EPC register contains the address of the preceding jump or Extend instruction, and the BD bit of the Cause register is set to 1.

Servicing

The Watch exception is a debugging aid; typically the exception handler transfers control to a debugger, allowing the user to examine the situation. To continue, once the Watch exception must be disabled to execute the faulting instruction. The Watch exception must then be reenabled. The faulting instruction can be executed either by the debugger or by setting breakpoints.

7.4.17 Interrupt exception

Cause

The Interrupt exception occurs when one of the eight interrupt conditions^{Note} is asserted. In the VR4181, interrupt requests from internal peripheral units first enter the ICU and are then notified to the CPU core via one of four interrupt sources (Int [3:0]) or NMI.

Each of the eight interrupts can be masked by clearing the corresponding bit in the IM field of the Status register, and all of the eight interrupts can be masked at once by clearing the IE bit of the Status register or setting the EXL/ERL bit.

Note They are 1 timer interrupt, 5 ordinary interrupts, and 2 software interrupts.

Of the five ordinary interrupts, Int4 is never asserted active.

Processing

The common exception vector is used for this exception, and the Int code in the ExcCode field of the Cause register is set.

The IP field of the Cause register indicates current interrupt requests. It is possible that more than one of the bits can be simultaneously set (or cleared) if the interrupt request signal is asserted and then deasserted before this register is read.

When the MIPS16 instruction is disabled, the EPC register contains the address of the instruction that caused the exception. However, if this instruction is in a branch delay slot, the EPC register contains the address of the preceding jump or branch instruction, and the BD bit of the Cause register is set to 1.

When the MIPS16 instruction is enabled, the EPC register contains the address of the instruction that caused the exception, and the least significant bit stores the ISA mode in which an exception occurs. However, if this instruction is in a branch delay slot or is the instruction following the Extend instruction, the EPC register contains the address of the preceding jump or Extend instruction, and the BD bit of the Cause register is set to 1.

Servicing

If the interrupt is caused by one of the two software-generated exceptions (SW0 or SW1), the interrupt condition is cleared by setting the corresponding Cause register bit to 0.

If the interrupt is caused by hardware, the interrupt condition is cleared by deactivating the corresponding interrupt request signal.

7.5 Exception Processing and Servicing Flowcharts

The remainder of this chapter contains flowcharts for the following exceptions and guidelines for their handlers:

- Common exceptions and a guideline to their exception handler
- TLB/XTLB Refill exception and a guideline to their exception handler
- Cold Reset, Soft Reset and NMI exceptions, and a guideline to their handler.

Generally speaking, the exceptions are "processed" by hardware (HW); the exceptions are then "serviced" by software (SW).

Figure 7-17. Common Exception Handling (1/2)

(a) Handling exceptions other than Cold reset, Soft reset, NMI, and TLB/XTLB Refill (hardware)

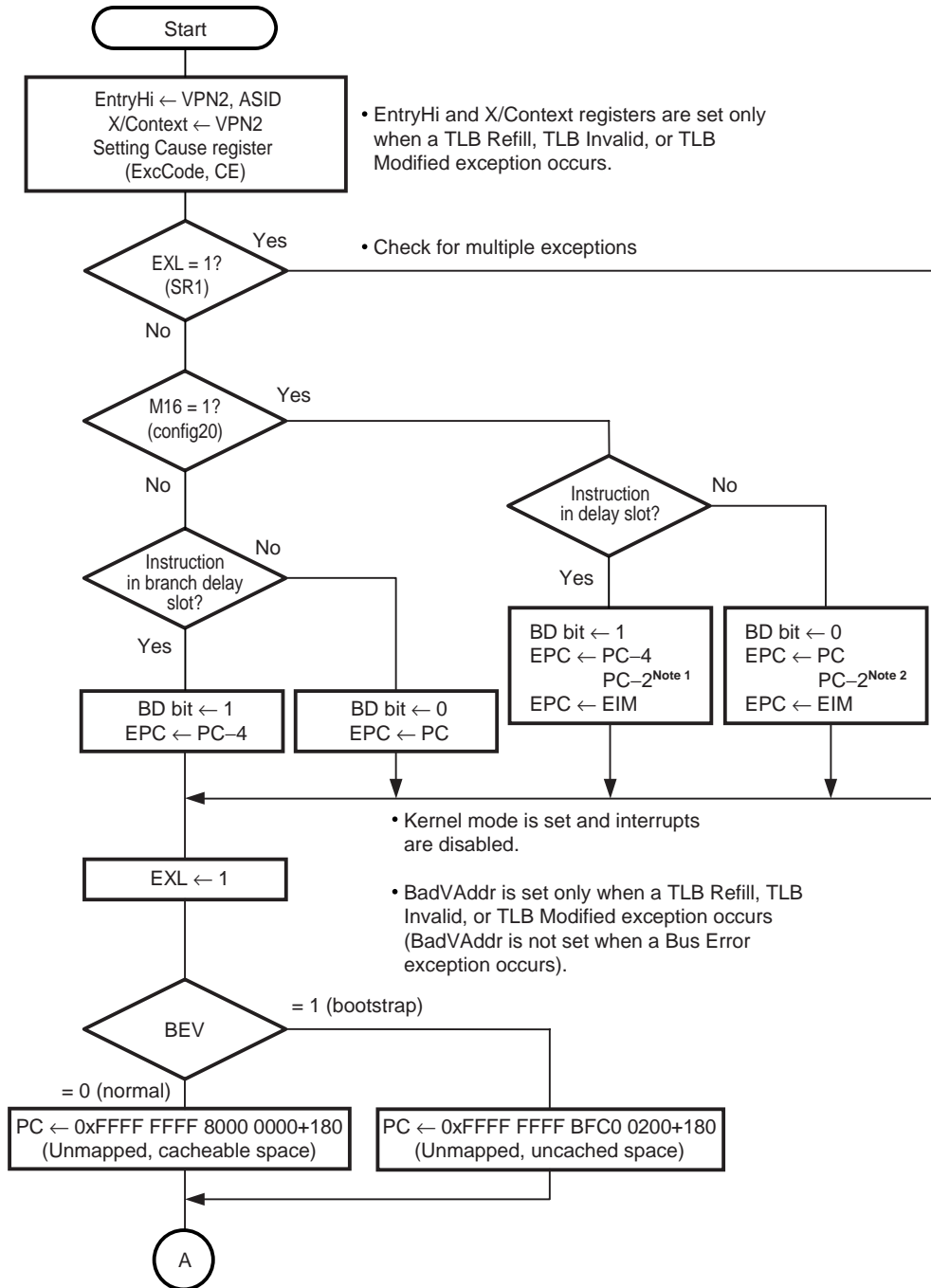

Notes 1. When the JR or JALR instruction of MIPS16 instructions

2. When the Extend instruction of MIPS16 instructions

Caution The interrupts can be masked by setting the IE or IM bit. The Watch exception can be set to pending state by setting the EXL bit.

Figure 7-17. Common Exception Handling (2/2)

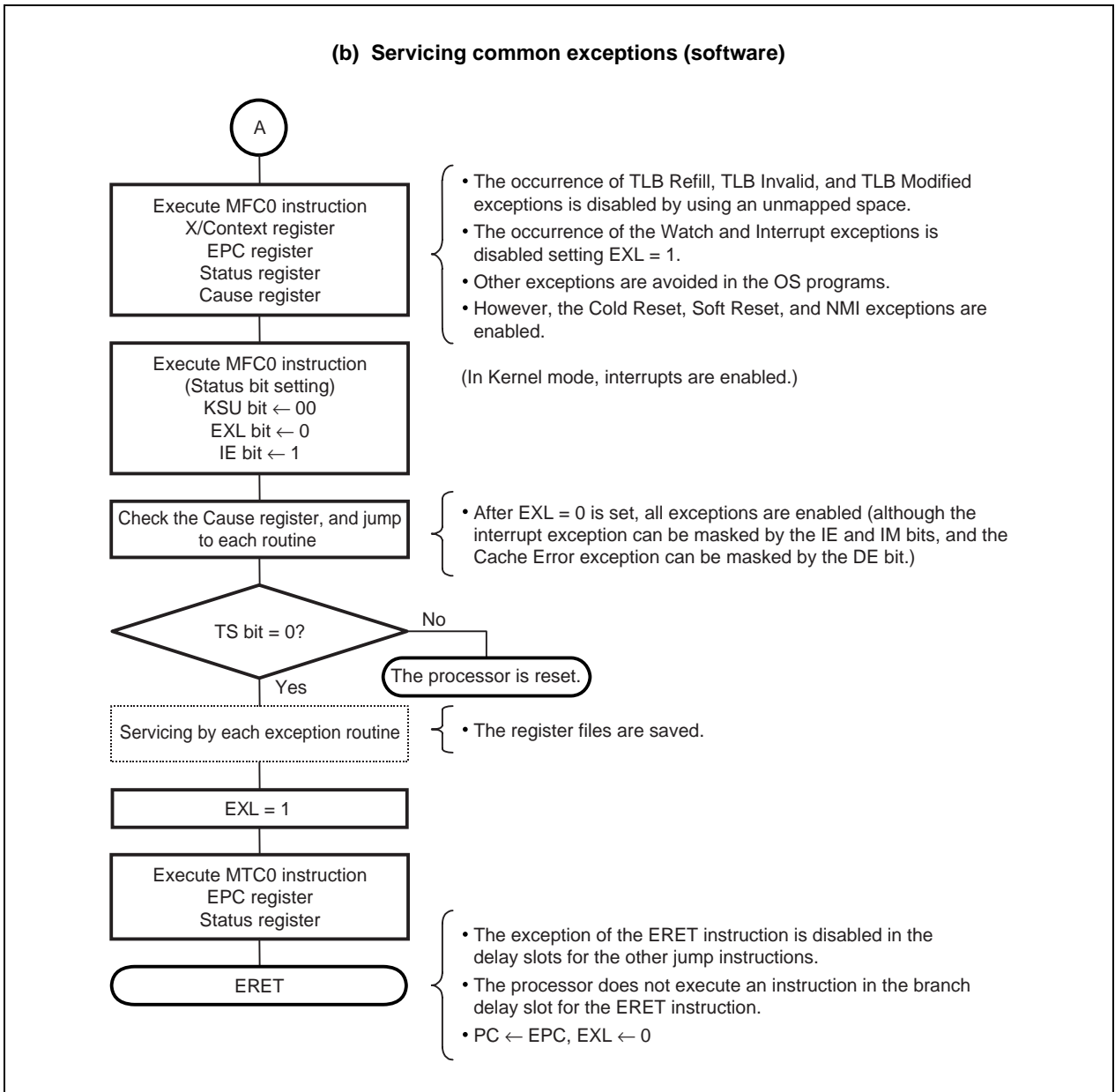

Figure 7-18. TLB/XTLB Refill Exception Handling (1/2)

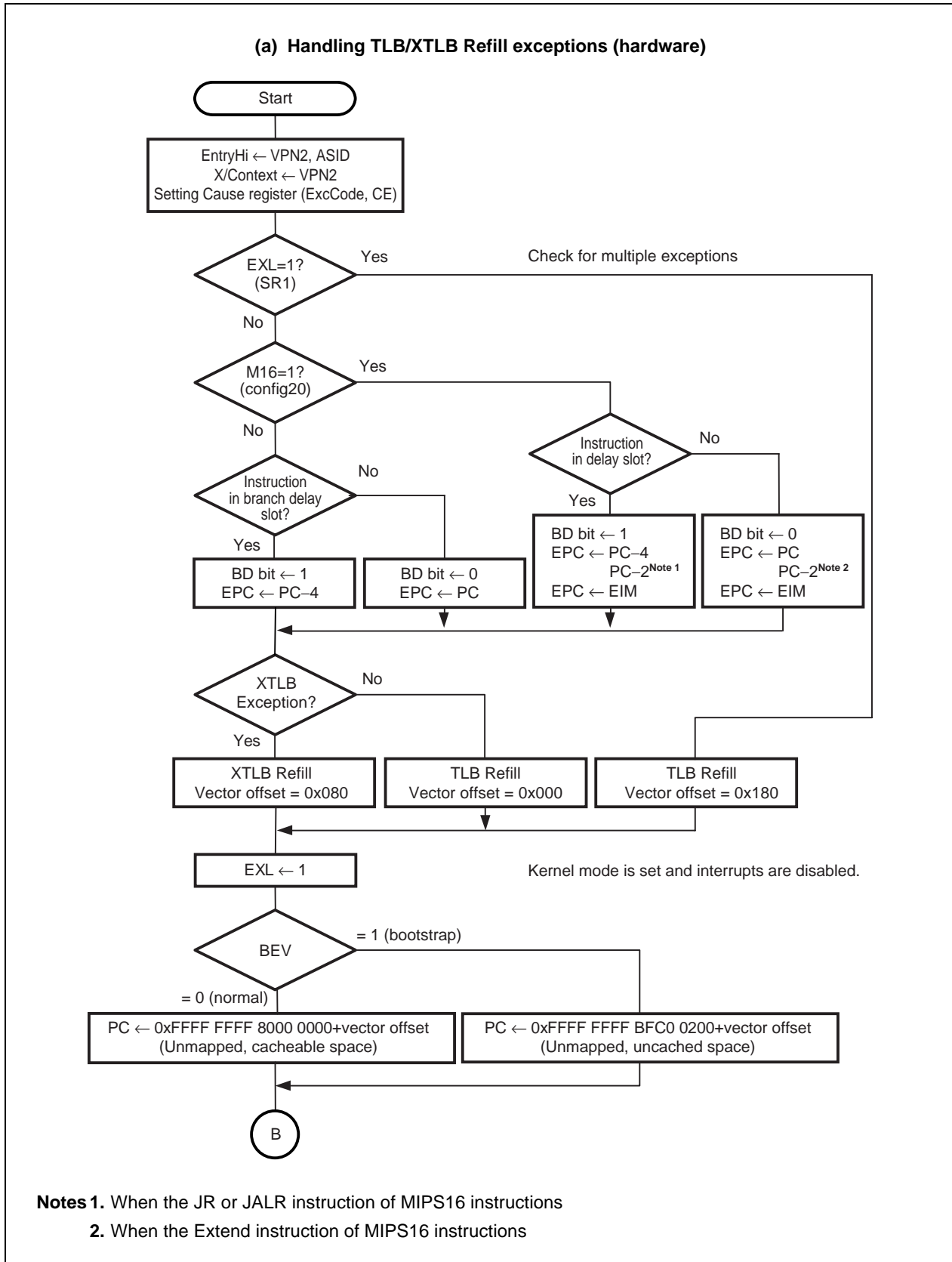

Figure 7-18. TLB/XTLB Refill Exception Handling (2/2)

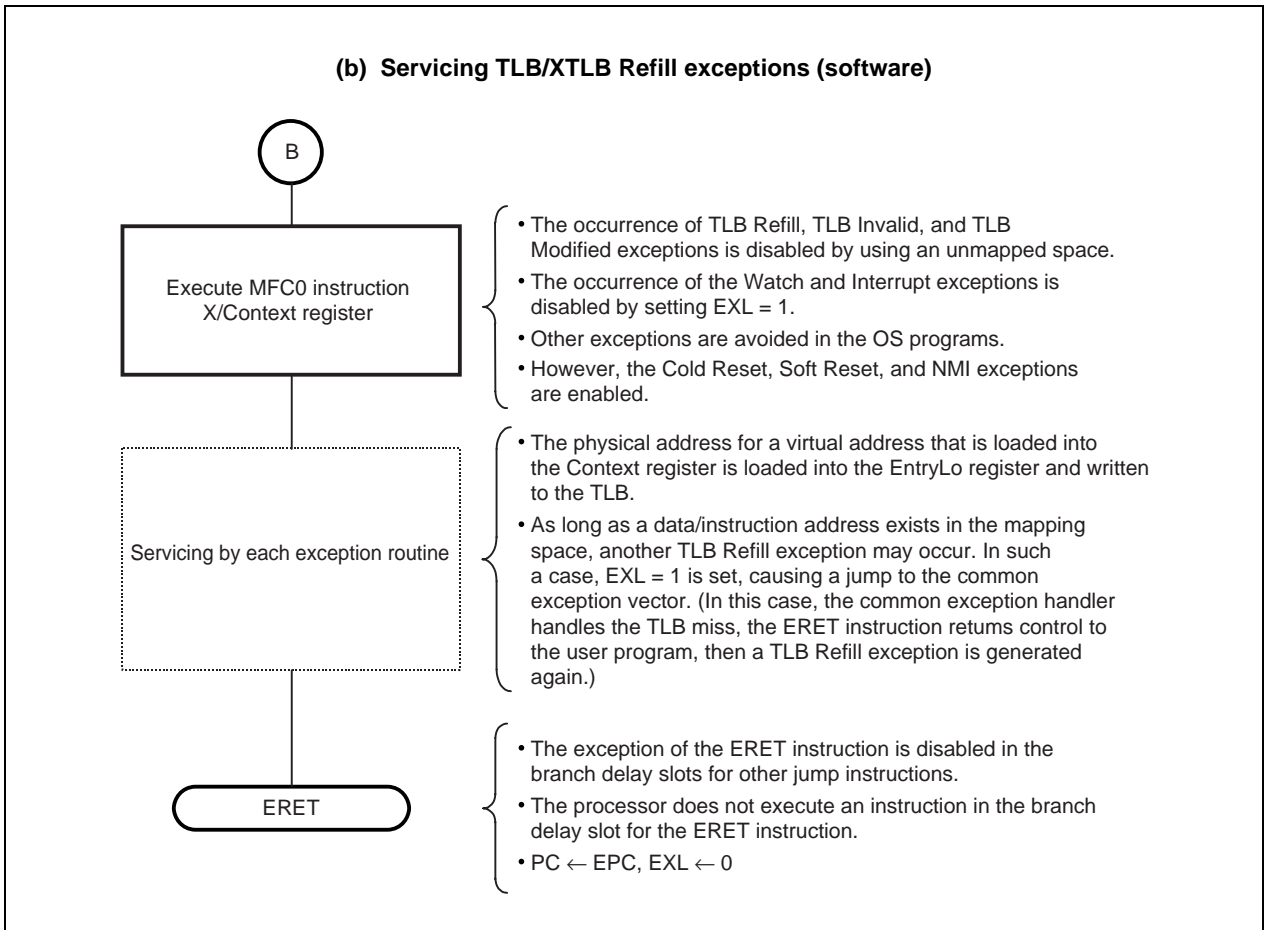

Figure 7-19. Cold Reset Exception Handling

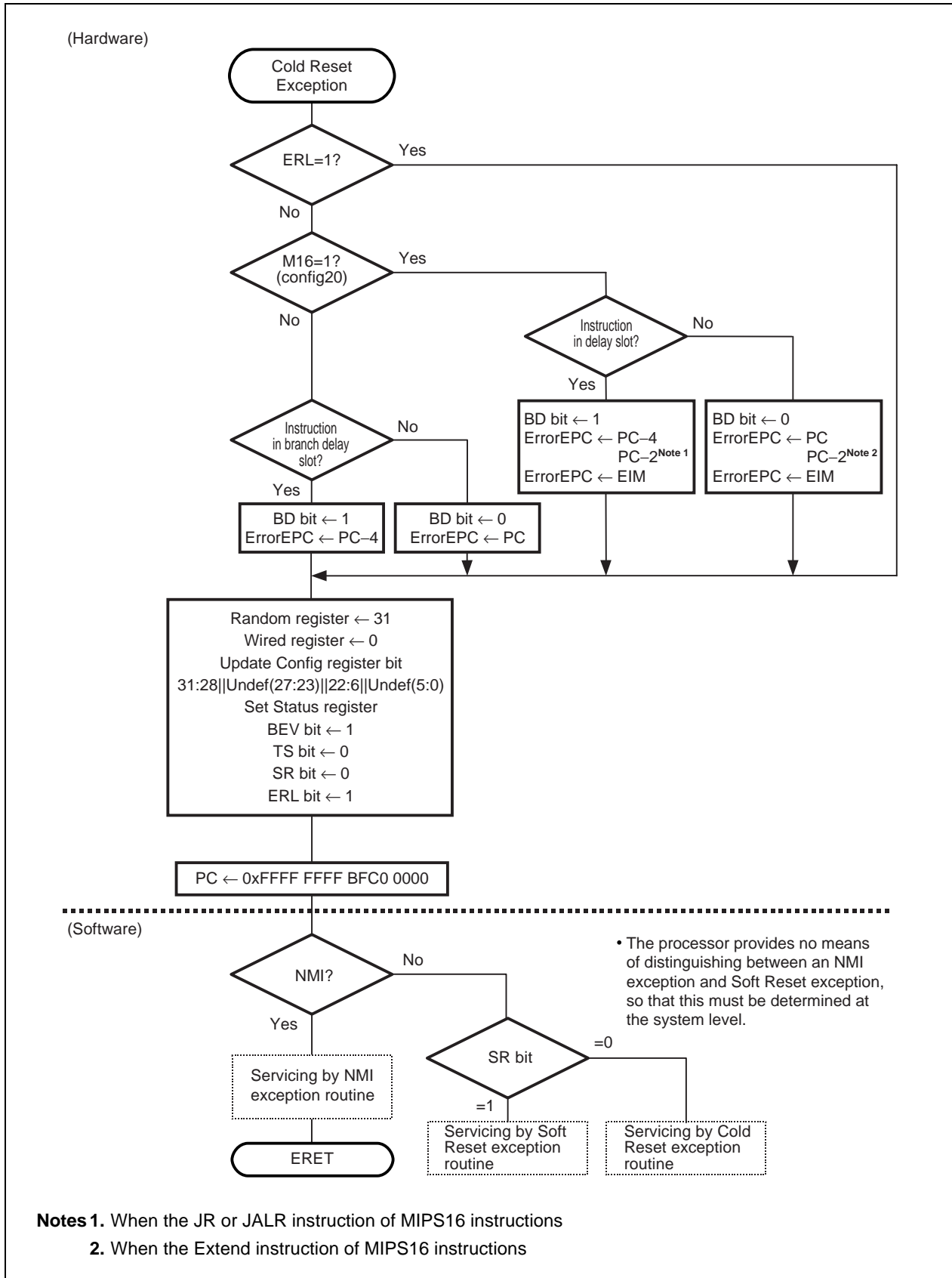
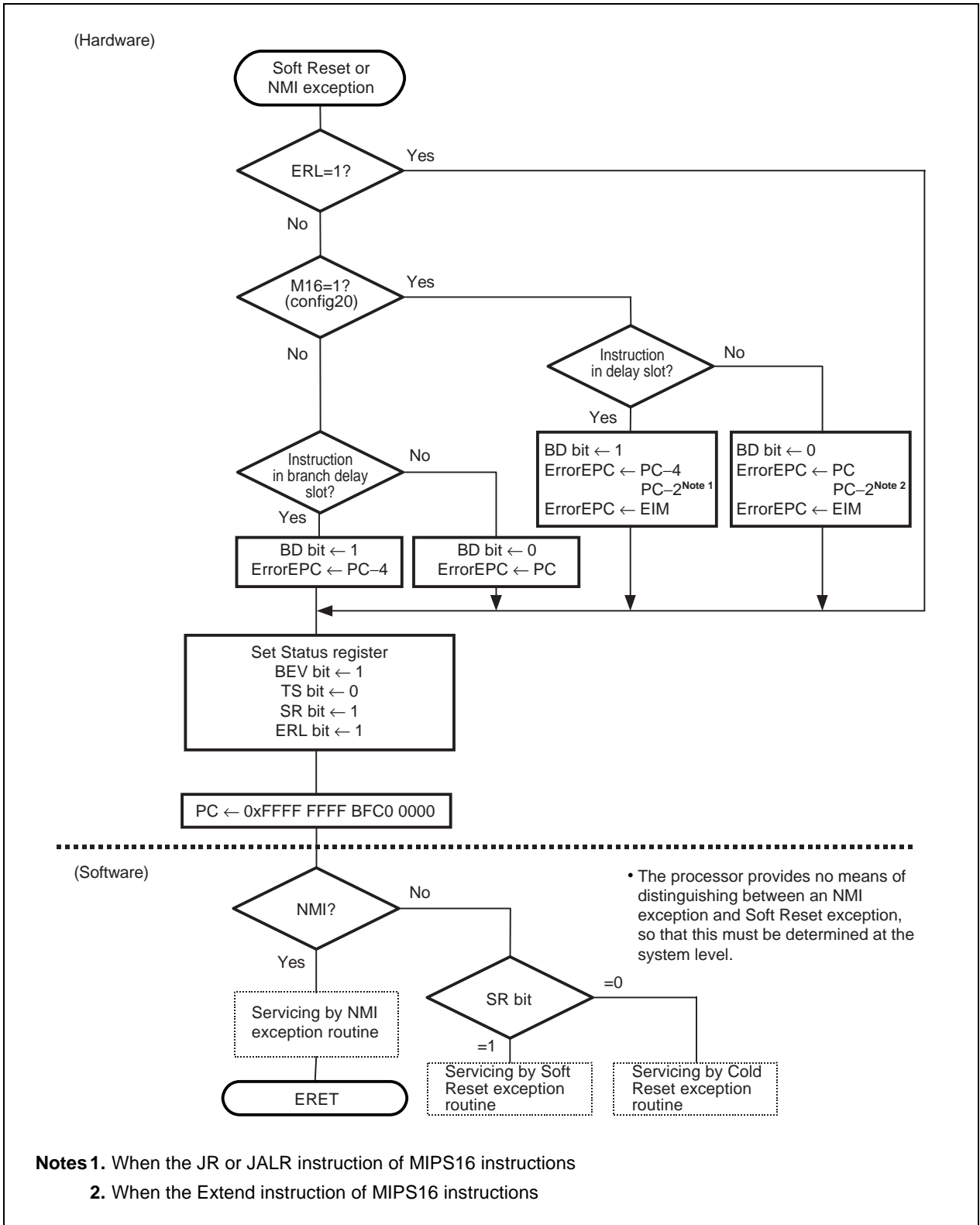

Figure 7-20. Soft Reset and NMI Exception Handling



[MEMO]

CHAPTER 8 INITIALIZATION INTERFACE

8.1 Overview

This chapter describes the initialization interface and processor modes. It also explains the reset signal descriptions and types, signal- and timing-related dependence, and the initialization sequence during each mode that can be selected by the user.

Remark # that follows signal names indicates active low.

8.2 Reset Function

There are five ways to reset the Vr4181. Each is summarized below.

8.2.1 RTC reset

During power-on, set the RTCRST# pin as active. After waiting 600 ms for the 32.768 kHz oscillator to begin oscillating when the power supply is stable at 3.0 V or above, setting the RTCRST# pin as inactive causes the RTC unit to begin counting. Then, the states of the MIPS16EN and CLKSEL(2:0) pins are read after one RTC cycle. Next, the Vr4181 asserts the POWERON pin and uses the BATTINH/BATTINT# signal to perform an activation check. If the activation check's result is OK, the Vr4181 asserts the MPOWER pin and waits for the stabilization time period (about 350 ms) for the external agent's DC/DC converter. Then the Vr4181 begins PLL oscillation and starts all clocks (a period of about 16 ms following the start of PLL oscillation is required for stabilization of PLL oscillation).

An RTC reset does not save any of the status information and it completely initializes the processor's internal state. Since the DRAM is not switched to self refresh mode, the contents of DRAM after an RTC reset are not at all guaranteed.

After a reset, the processor begins to access the reset vectors in the ROM space. Since only part of the internal status is reset when a reset occurs in the Vr4181, the processor should be completely initialized by software.

After power-on, the processor's pin statuses are undefined since the RTCRST# is asserted, until the 32.768 kHz clock oscillator starts oscillation. The pin statuses after oscillation starts are described in **CHAPTER 2 PIN FUNCTIONS** in this document.

Figure 8-1. RTC Reset

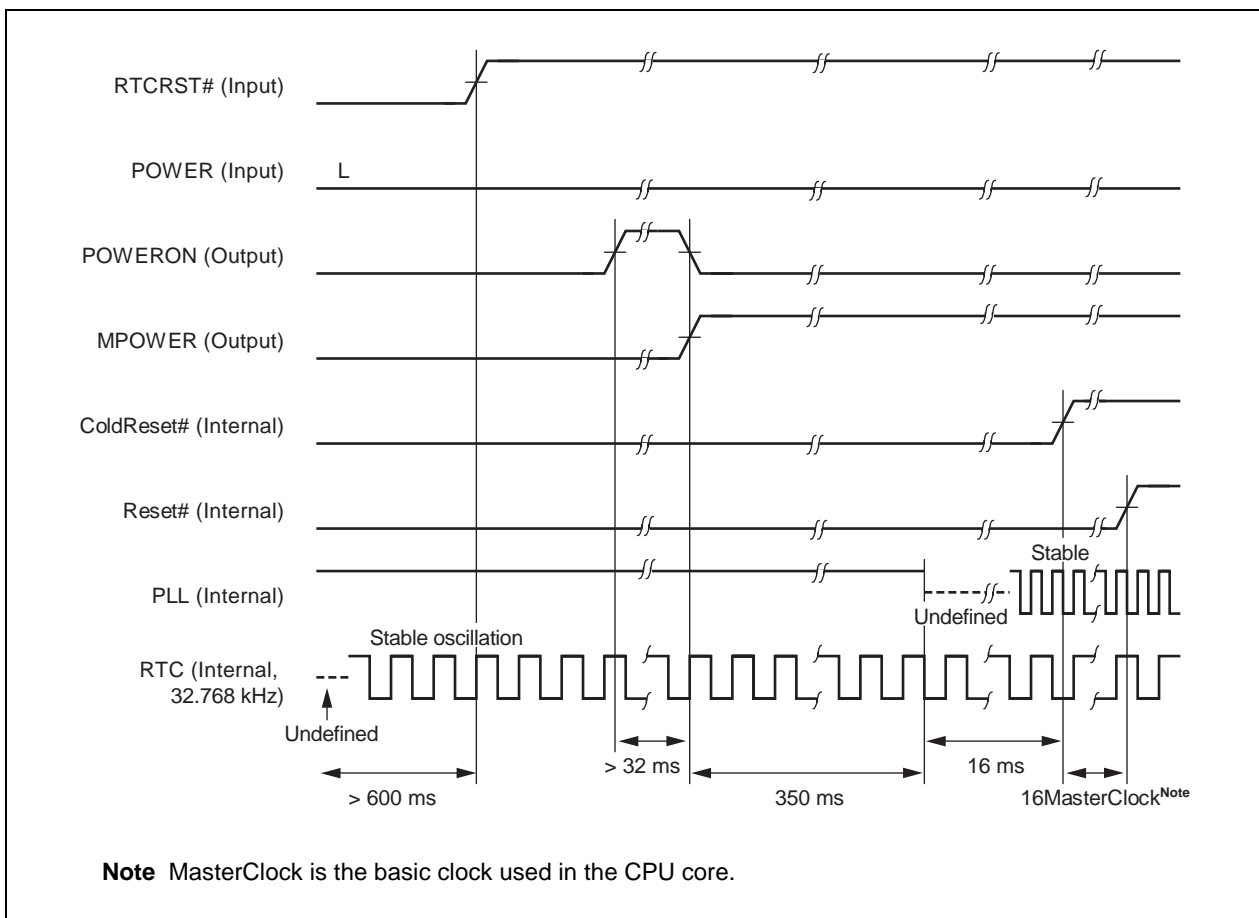

8.2.2 RSTSW

After the RSTSW# pin becomes active and then becomes inactive 100 μ s later, the Vr4181 starts PLL oscillation and starts all clocks (a period of about 16 ms following the start of PLL oscillation is required for stabilization of PLL oscillation).

A reset by RSTSW# basically initializes the entire internal state except for the RTC timer and the PMU. The Vr4181 has function to preserve DRAM data during RSTSW reset. For detail, please refer to **CHAPTER 15 POWER MANAGEMENT UNIT (PMU)**.

After a reset, the processor becomes the system bus master and it begins to access the reset vectors in the ROM space. Since only part of the internal status is reset when a reset occurs in the Vr4181, the processor should be completely initialized by software.

Figure 8-2. RSTSW

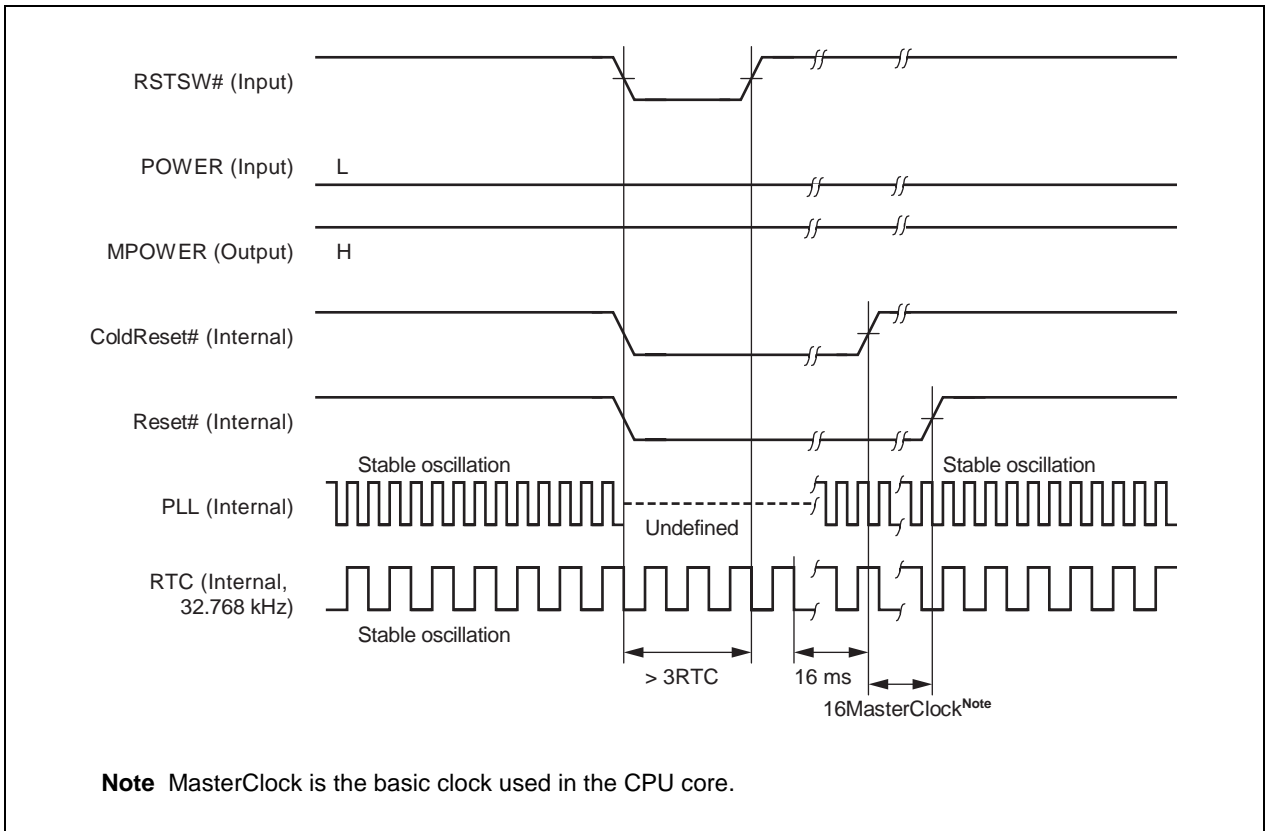

8.2.3 Deadman's Switch

After the Deadman's Switch unit is enabled, if the Deadman's Switch is not cleared within the specified time period, the VR4181 is immediately returned to reset status. Setting and clearing of the Deadman's Switch is performed by software.

A reset by the Deadman's Switch initializes the entire internal state except for the RTC timer and the PMU. Since the DRAM is not switched to self-refresh mode, the contents of DRAM after a Deadman's Switch reset are not at all guaranteed.

After a reset, the processor becomes the system bus master and it begins to access the reset vectors in the ROM space. Since only part of the internal status is reset when a reset occurs in the VR4181, the processor should be completely initialized by software.

Figure 8-3. Deadman's Switch

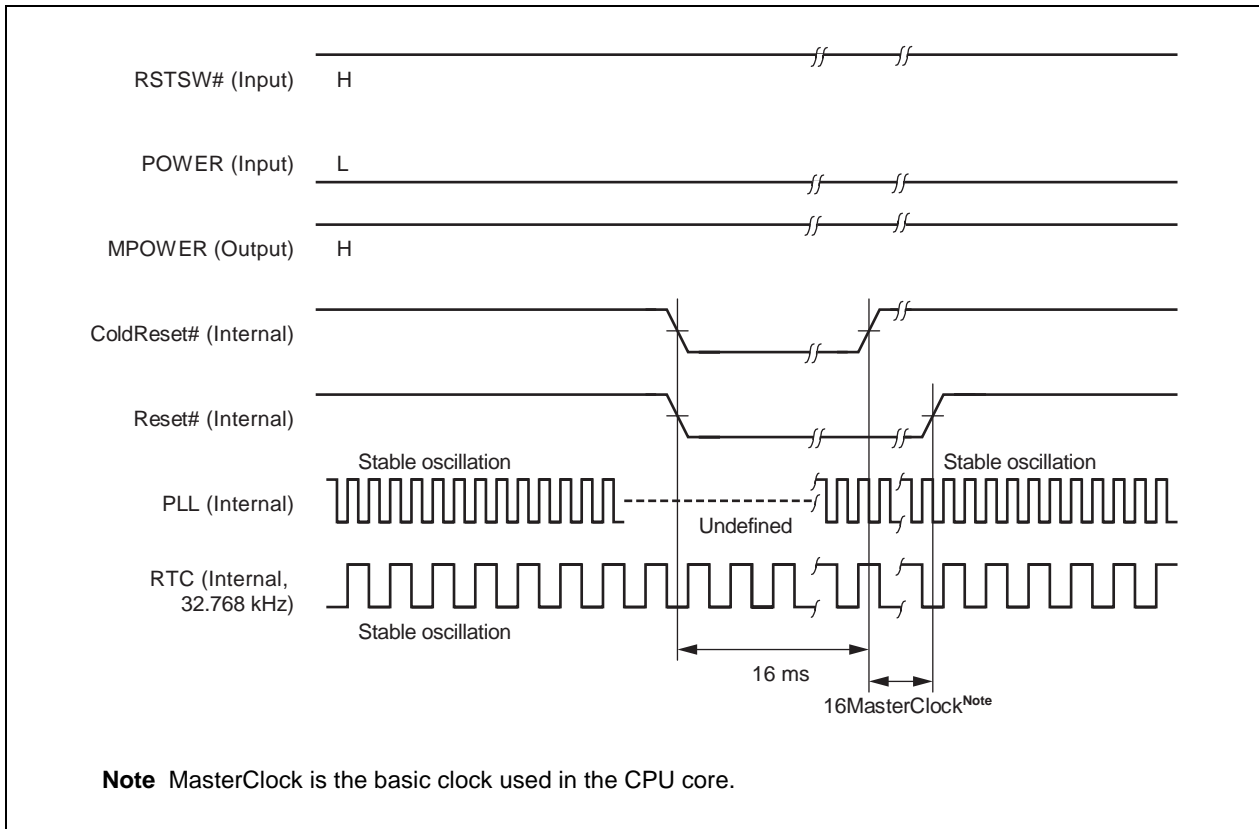

8.2.4 Software shutdown

When the software executes the HIBERNATE instruction, the Vr4181 sets the MPOWER pin as inactive, then enters reset status. Recovery from reset status occurs when the POWER pin or DCD# signal is asserted or when an unmasked wake-up interrupt request is occurred.

A reset by software shutdown initializes the entire internal state except for the RTC timer and the PMU.

After a reset, the processor becomes the system bus master and it begins to access the reset vectors in the ROM space. Since only part of the internal status is reset when a reset occurs in the Vr4181, the processor should be completely initialized by software.

Caution The Vr4181 does not sets the DRAM to self-refresh mode by executing HIBERNATE instruction. To preserve DRAM data, software must set the DRAM to self-refresh mode. For details, refer to CHAPTER 15 POWER MANAGEMENT UNIT (PMU).

Figure 8-4. Software Shutdown

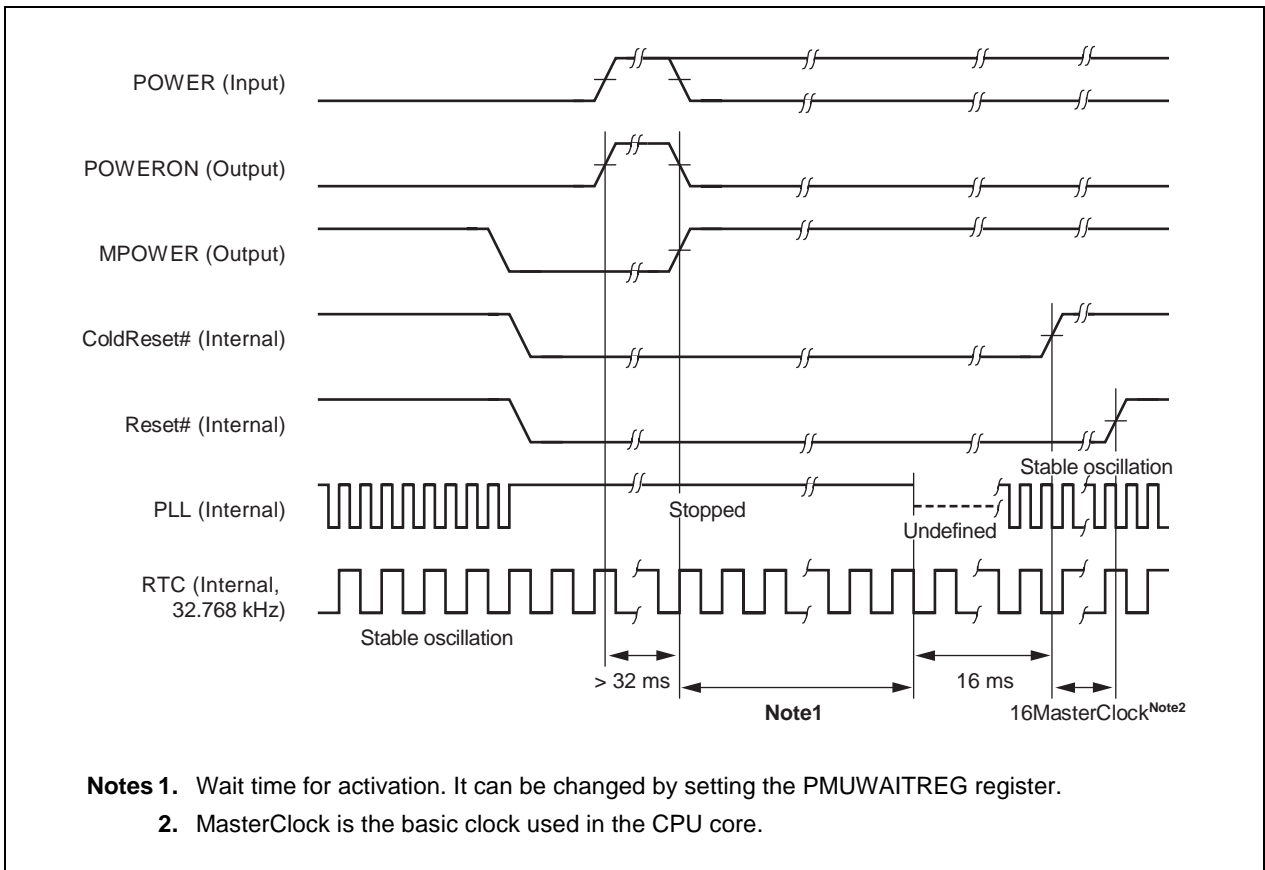

8.2.5 HALTimer shutdown

After an RTC reset is canceled, if the HALTimer is not canceled by software within about four seconds, the Vr4181 enters reset status. Recovery from reset status occurs when the POWER pin is asserted or when a WakeUpTimer interrupt request occurs.

A reset by HALTimer initializes the entire internal state except for the RTC timer and the PMU.

After a reset, the processor becomes the system bus master and it begins to access the reset vectors in the ROM space. Since only part of the internal status is reset when a reset occurs in the Vr4181, the processor should be completely initialized by software.

Caution The Vr4181 does not sets the DRAM to self-refresh mode by HALTimer shutdown. Since the DRAM is not switched to self-refresh mode, the contents of DRAM after a HALTimer shutdown reset are not at all guaranteed.

Figure 8-5. HALTimer shutdown

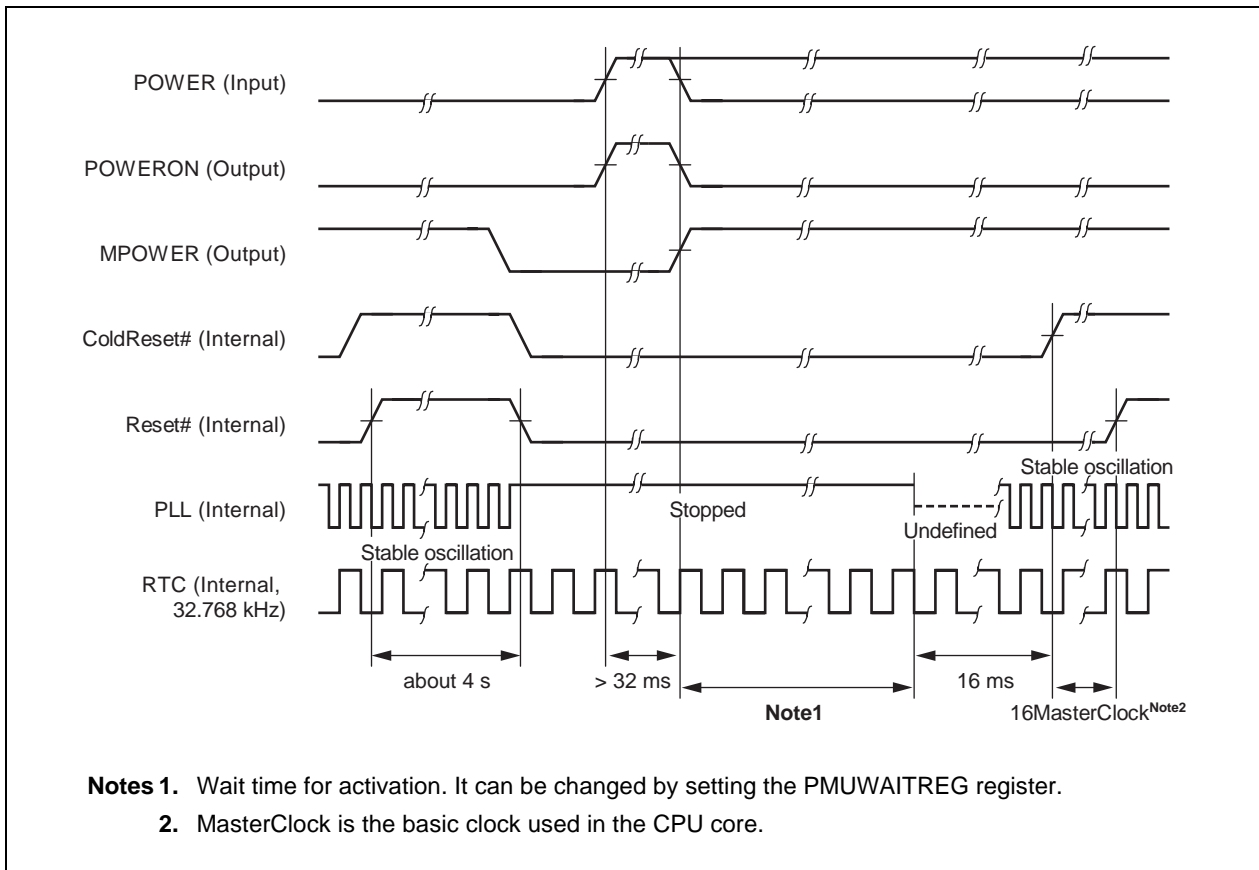

8.3 Power On Sequence

The factors that cause the Vr4181 to switch from Hibernate mode or shutdown mode to Fullspeed mode are called activation factors. There are five activation factors: assertion of the POWER pin, the DCD# pin or the GPIO(15:0) pins, or activation of the Elapsed Timer or CompactFlash interrupt request. When an activation factor occurs, the Vr4181 asserts the POWERON pin, then provides notification to external agents that the Vr4181 is ready for power-on. Three RTC clock after the POWERON pin is asserted, the Vr4181 checks the state of the BATTINH/BATTINT# pin. If the BATTINH/BATTINT# pin's state is low, the POWERON pin is deasserted one RTC clock after the BATTINH/BATTINT# pin check is completed, then the Vr4181 is not activated. If the BATTINH/BATTINT# pin's state is high, the POWERON pin is deasserted three RTC clocks after the BATTINH/BATTINT# pin check is completed, then the MPOWER pin is asserted and the Vr4181 is activated.

Figure 8-6 shows a timing chart of Vr4181 activation and Figure 8-7 shows a timing chart of when activation fails due to the BATTINH/BATTINT# pin's "low" state.

Remark While the MPOWER pin is inactive, 2.5 V power supply of Vr4181 (VDD_LOGIC, VDD_PLL) is not needed. In order to reduce leak current, we recommend turning on/off the 2.5 V power supply of Vr4181 by MPOWER pin state.

Figure 8-6. Vr4181 Activation Sequence (when activation is OK)

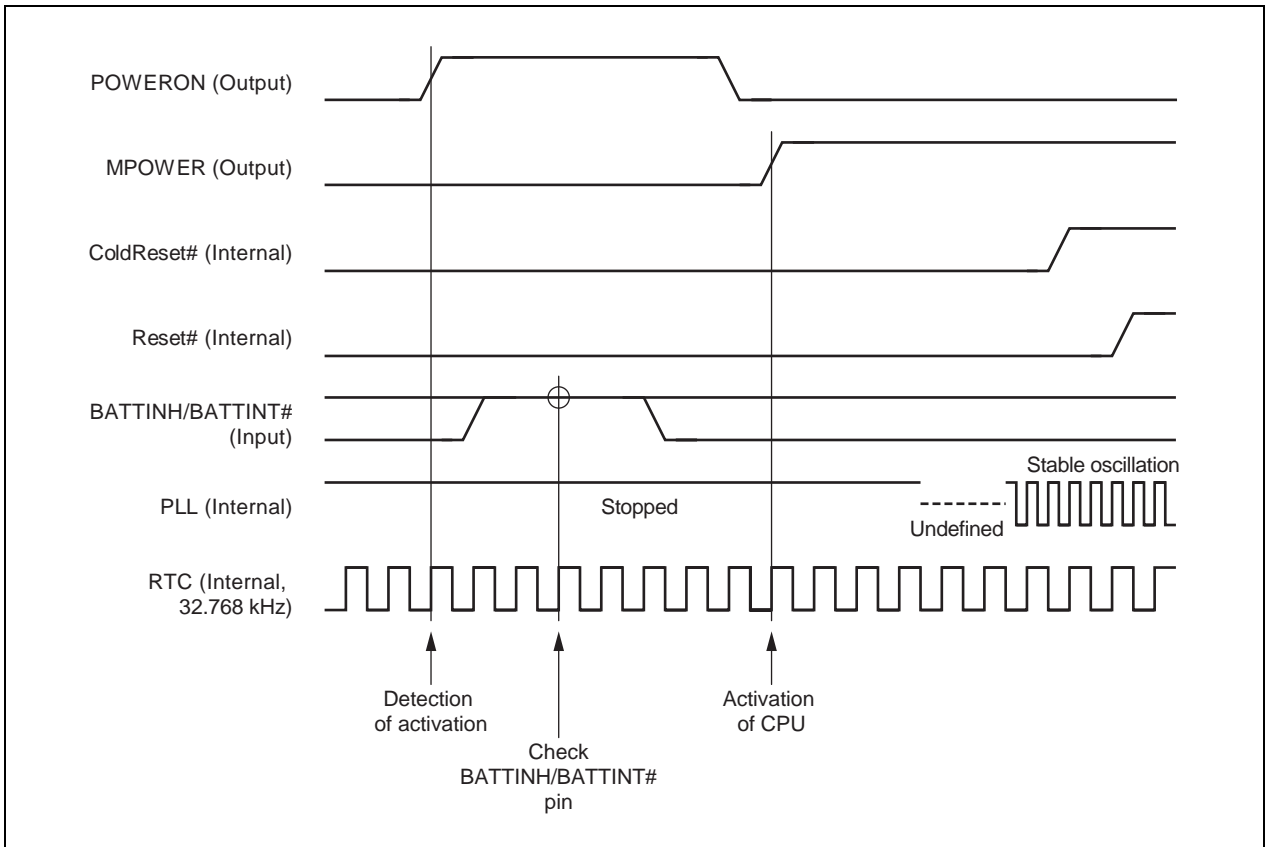
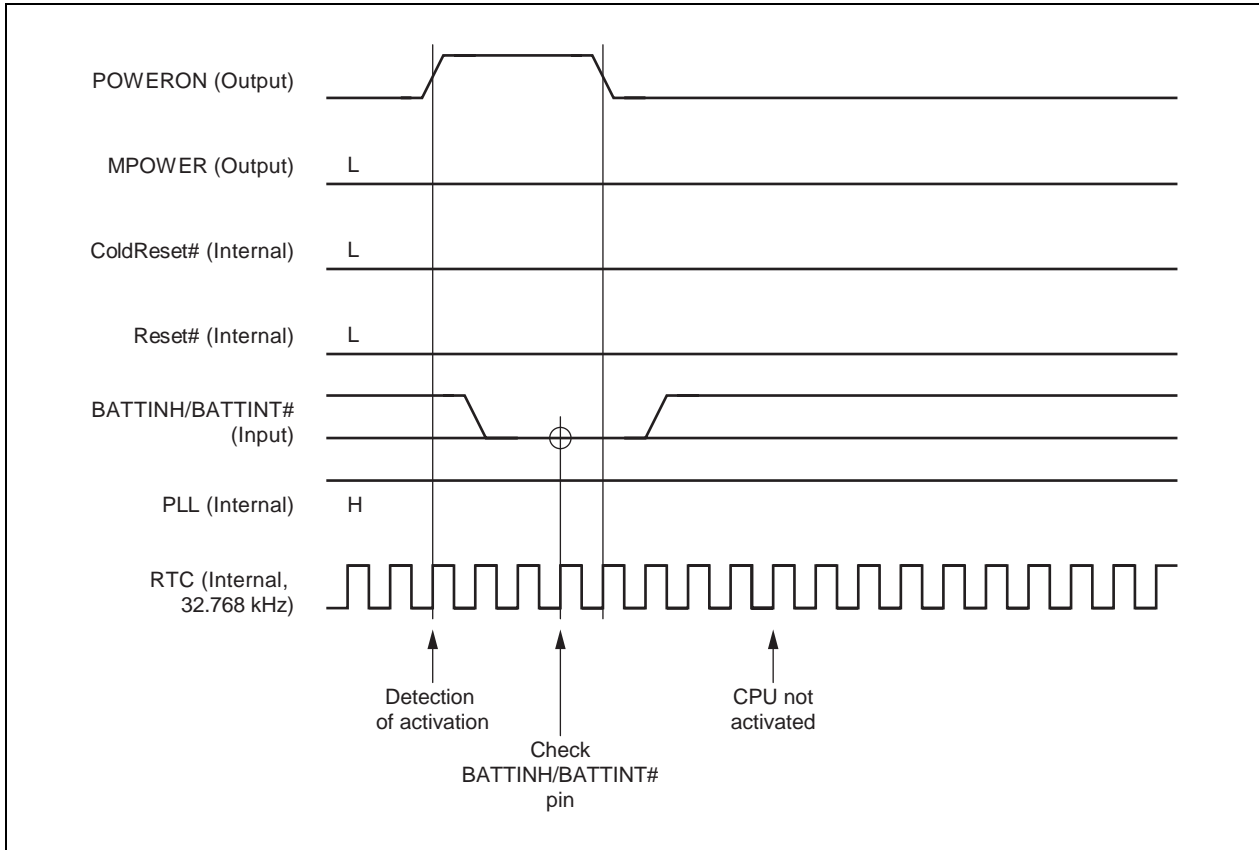

Figure 8-7. V_R4181 Activation Sequence (when activation is NG)



8.4 Reset of CPU Core

This section describes the reset sequence of the VR4110 CPU core.

8.4.1 Cold Reset

In the VR4181, a Cold Reset sequence is executed in the CPU core in the following cases:

- RTC reset
- RSTSW reset
- Deadman's Switch shutdown
- Software shutdown
- HALTimer shutdown
- Battery low shutdown
- Battery lock release shutdown

A Cold Reset completely initializes the CPU core, except for the following register bits.

- The TS and SR bits of the Status register are cleared to 0.
- The ERL and BEV bits of the Status register are set to 1.
- The upper limit value (31) is set in the Random register.
- The Wired register is initialized to 0.
- Bits 31 to 28 of the Config register are set to 0 and bits 22 to 3 to 0x04800; the other bits are undefined.
- The values of the other registers are undefined.

Once power to the processor is established, the ColdReset# (internal) and the Reset# (internal) signals are asserted and a Cold Reset is started. After approximately 2 ms assertion, the ColdReset# signal is deasserted synchronously with MasterOut. Then the Reset# signal is deasserted synchronously with MasterOut, and the Cold Reset is completed.

Upon reset, the CPU core becomes bus master and drives the SysAD bus (internal). After Reset# is deasserted, the CPU core branches to the Reset exception vector and begins executing the reset exception code.

Figure 8-8. Cold Reset

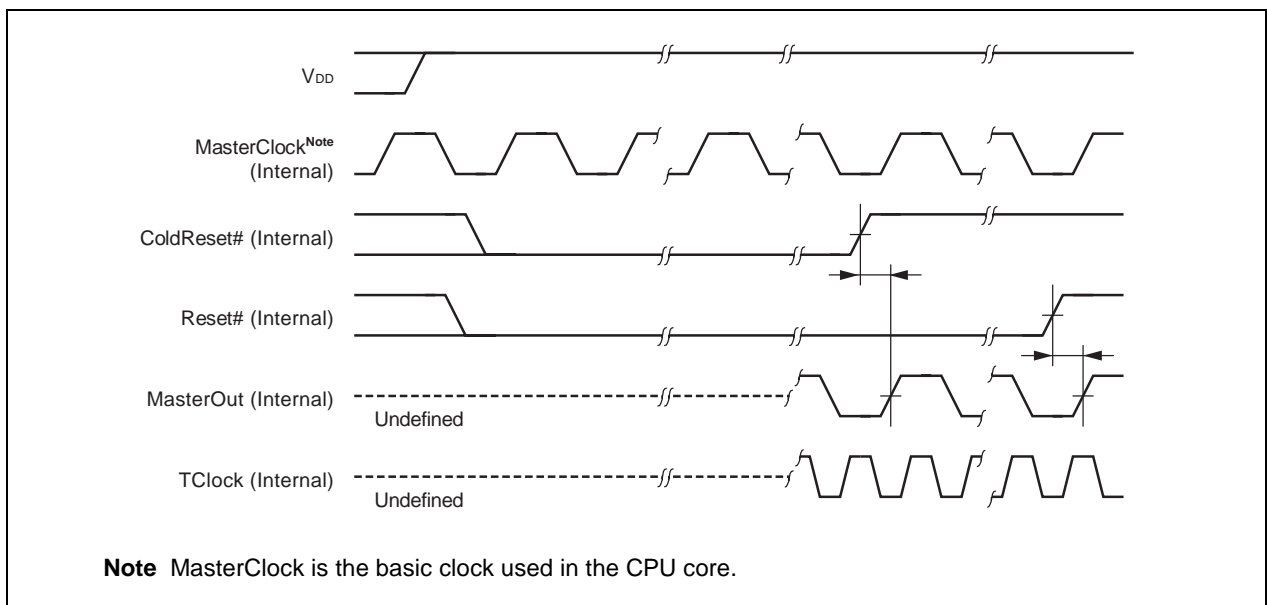

8.4.2 Soft Reset

Caution Soft Reset is not supported in the present Vr4181.

A Soft Reset initializes the CPU core without affecting the clocks; in other words, a Soft Reset is a logical reset. In a Soft Reset, the CPU core retains as much state information as possible; all state information except for the following is retained:

- The TS bit of the Status register is cleared to 0.
- The SR, ERL and BEV bits of the Status register are set to 1.
- The Count register is initialized to 0.
- The IP7 bit of the Cause register is cleared to 0.
- Any Interrupts generated on the SysAD bus are cleared.
- NMI is cleared.
- The Config register is initialized.

A Soft Reset is started by assertion of the Reset# signal, and is completed at the deassertion of the Reset# signal synchronized with MasterOut. In general, data in the CPU core is preserved for debugging purpose.

Upon reset, the CPU core becomes bus master and drives the SysAD bus (internal). After Reset# is deasserted, the CPU core branches to the Reset exception vector and begins executing the reset exception code.

Figure 8-9. Soft Reset

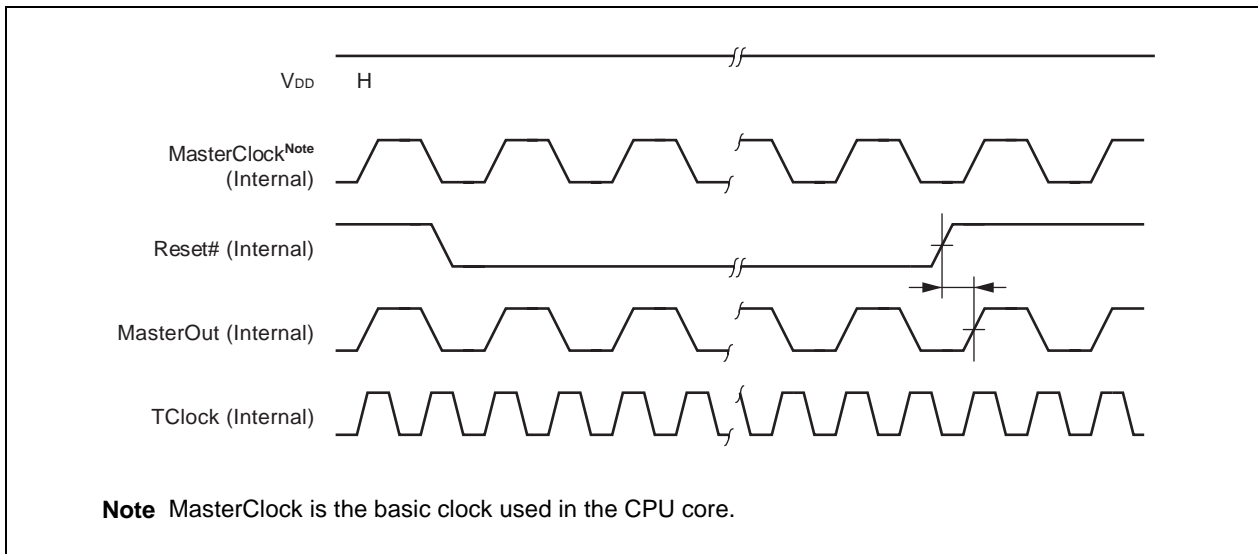

8.5 VR4181 Processor Modes

The VR4181 supports various modes, which can be selected by the user. The CPU core mode is set each time a write occurs in the Status register and Config register. The modes of on-chip peripheral circuits are set by writing to the I/O register.

This section describes the CPU core's operation modes. For operation modes of on-chip peripheral circuits, see the chapters describing the various units.

8.5.1 Power modes

The VR4181 supports four power modes: Fullspeed mode, Standby mode, Suspend mode, and Hibernate mode.

(1) Fullspeed mode

This is the normal operation mode.

The VR4181's default status sets operation under Fullspeed mode. After the processor is reset, the VR4181 returns to Fullspeed mode.

(2) Standby mode

When a STANDBY instruction has been executed, the processor can be set to Standby mode. During Standby mode, all of the internal clocks in the CPU core except for the timer, interrupt, memory controller and LCD controller clocks are held at high level. The peripheral units all operate as they do during Fullspeed mode. This means that DMA operations are enabled during Standby mode.

When the STANDBY instruction completes the WB stage, the VR4181 remains idle until the SysAD internal bus enters the idle state. Next, the clocks in the CPU core are shut down and pipeline operation is stopped. However, the PLL, timer, interrupt, memory controller and LCD controller clocks continue to operate, as do the internal bus clocks (SClock, TClock, and MasterOut).

During Standby mode, the processor returns to Fullspeed mode if any interrupt request occurs, including a timer interrupt that occurs internally.

(3) Suspend mode

When the SUSPEND instruction has been executed, the processor can be set to Suspend mode. During Suspend mode, the processor stalls the pipeline and all of the internal clocks in the CPU core except for PLL timer and interrupt clocks are held at high level. The VR4181 stops supplying TClock to peripheral units. Accordingly, during Suspend mode peripheral units can only be activated by a special interrupt unit (DCD# control, etc.). While in this mode, the register and cache contents are retained.

When the SUSPEND instruction completes the WB stage, the VR4181 waits for the SysAD internal bus to enter the idle state. Next, the clocks in the CPU core are shut down and pipeline operation is stopped. The VR4181 then stops supplying TClock to peripheral units. However, the PLL, timer, and interrupt clocks continue to operate, as do the MasterOut.

The processor remains in Suspend mode until an interrupt request is received, at which time it returns to Fullspeed mode.

(4) Hibernate mode

When the HIBERNATE instruction has been executed, the processor can be set to Hibernate mode. During Hibernate mode, the processor stops supplying clocks to all units. The register and cache contents are retained and output of TClock and MasterOut is stopped.

The processor remains in Hibernate mode until occurrence of an activation factor, which is assertion of the POWER pin or the DCD# pin, or activation of the Elapsed Timer interrupt request etc. When the activation factor occurs, the processor returns to Fullspeed mode.

Power consumption during Hibernate mode is about 0 W (it does not go completely to 0 W due to the existence of a 32.768 kHz oscillator or on-chip peripheral circuits that operate at 32.768 kHz).

8.5.2 Privilege mode

The Vr4181 supports three system modes: kernel expanded addressing mode, supervisor expanded addressing mode, and user expanded addressing mode. These three modes are described below.

(1) Kernel expanded addressing mode

When the Status register's KX bit has been set, an Expanded TLB Refill exception vector is used when a TLB refill occurs for the kernel address. While in Kernel mode, the MIPS III operation code can always be used, regardless of the KX bit.

(2) Supervisor expanded addressing mode

When the Status register's SX bit has been set, the MIPS III operation code can be used in Supervisor mode and an Expanded TLB Refill exception vector is used when a TLB refill occurs for the Supervisor address.

(3) User expanded addressing mode

When the Status register's UX bit has been set, the MIPS III operation code can be used in User mode, and an Expanded TLB Refill exception vector is used when a TLB refill occurs for the User address. When this bit is cleared, the MIPS I and II operation codes can be used, as can 32-bit virtual addresses.

8.5.3 Reverse endian

When the Status register's RE bit has been set, the endian ordering is reversed to adopt the user software's perspective. However, the RE bit of the Status register must be set to 0 since the Vr4181 supports the little-endian order only.

8.5.4 Bootstrap exception vector (BEV)

The BEV bit is used to generate an exception during operation testing (diagnostic testing) of the cache and main memory system.

When the Status register's BEV bit has been set, the address of the TLB Refill exception vector is changed to the virtual address 0xFFFF FFFF BFC0 0200 and the ordinary exception vector is changed to address 0xFFFF FFFF BFC0 0380.

When the BEV bit is cleared, the TLB miss exception vector's address is changed to 0xFFFF FFFF 8000 0000 and the ordinary exception vector is changed to address 0xFFFF FFFF 8000 0180.

8.5.5 Cache error check

The CE bit of the Status register is meaningless because the VR4181 has no cache parity.

8.5.6 Parity error prohibit

The VR4181 processor does not issue any cache parity error exceptions regardless of the DE bit of the Status register.

8.5.7 Interrupt enable (IE)

When the Status register's IE bit has been cleared, no interrupts can be received except for reset interrupt and non-maskable interrupt requests.

[MEMO]

CHAPTER 9 CACHE MEMORY

This chapter describes in detail the cache memory: its place in the VR4110 CPU core memory organization, and individual organization of the caches.

This chapter uses the following terminology:

- The data cache may also be referred to as the D-cache.
- The instruction cache may also be referred to as the I-cache.

These terms are used interchangeably throughout this book.

9.1 Memory Organization

Figure 9-1 shows the VR4110 CPU core system memory hierarchy. In the logical memory hierarchy, the caches lie between the CPU and main memory. They are designed to make the speedup of memory accesses transparent to the user.

Each functional block in Figure 9-1 has the capacity to hold more data than the block above it. For instance, physical main memory has a larger capacity than the caches. At the same time, each functional block takes longer to access than any block above it. For instance, it takes longer to access data in main memory than in the CPU on-chip registers.

Figure 9-1. Logical Hierarchy of Memory

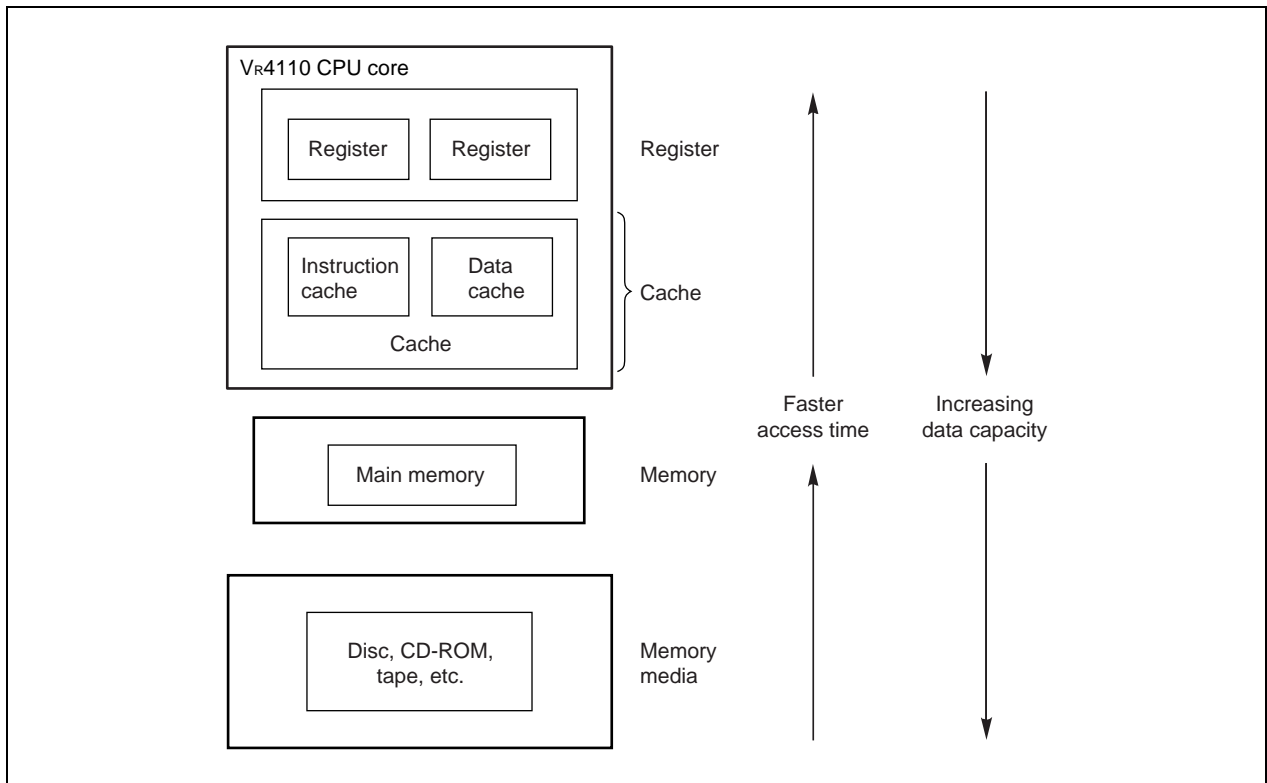

The V_R4110 CPU core has two on-chip caches: one holds instructions (the instruction cache), the other holds data (the data cache). The instruction and data caches can be read in one PClock cycle.

2 PCycles are needed to write data. However, data writes are pipelined and can complete at a rate of one per PClock cycle. In the first stage of the cycle, the store address is translated and the tag is checked; in the second stage, the data is written into the data RAM.

9.2 Cache Organization

This section describes the organization of the on-chip data and instruction caches. Figure 9-2 provides a block diagram of the V_R4110 CPU core cache and memory model.

Figure 9-2. Cache Support

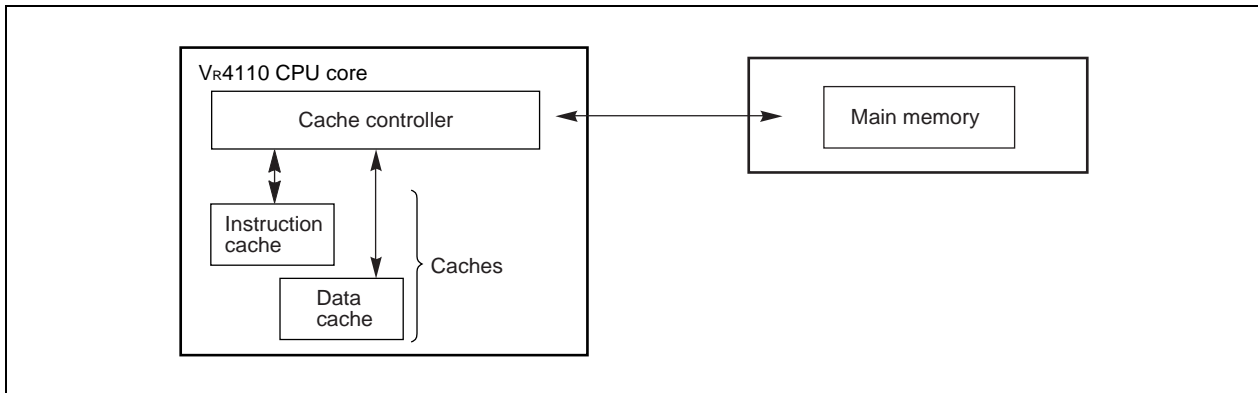

(1) Cache Line Lengths

A cache line is the smallest unit of information that can be fetched from main memory for the cache, and that is represented by a single tag.

The line size for the instruction/data cache is 4 words (16 bytes).

For the cache tag, see 9.2.1 and 9.2.2.

(2) Cache Sizes

The instruction cache in the V_R4181 is 4 Kbytes; the data cache is 4 Kbytes.

9.2.1 Organization of the instruction cache (I-cache)

Each line of I-cache data (although it is actually an instruction, it is referred to as data to distinguish it from its tag) has an associated 23-bit tag that contains a 22-bit physical address, and a single valid bit.

The V_R4110 CPU core I-cache has the following characteristics:

- direct-mapped
- indexed with a virtual address
- checked with a physical tag
- organized with a 4-word (16-byte) cache line.

Figure 9-3 shows the format of a 4-word (16-byte) I-cache line.

Figure 9-3. Instruction Cache Line Format

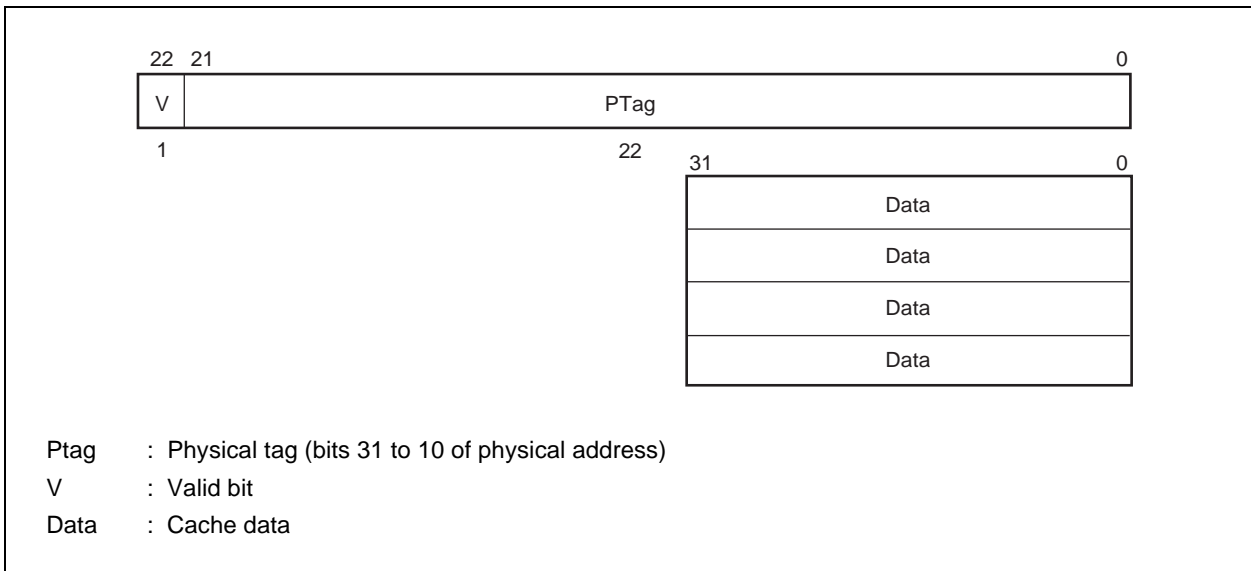

9.2.2 Organization of the data cache (D-cache)

Each line of D-cache data has an associated 25-bit tag that contains a 22-bit physical address, a Valid bit, a Dirty bit, and a Write-back bit.

The VR4110 CPU core D-cache has the following characteristics :

- write-back
- direct-mapped
- indexed with a virtual address
- checked with a physical tag
- organized with a 4-word (16-byte) cache line.

Figure 9-4 shows the format of a 4-word (16-byte) D-cache line.

Figure 9-4. Data Cache Line Format

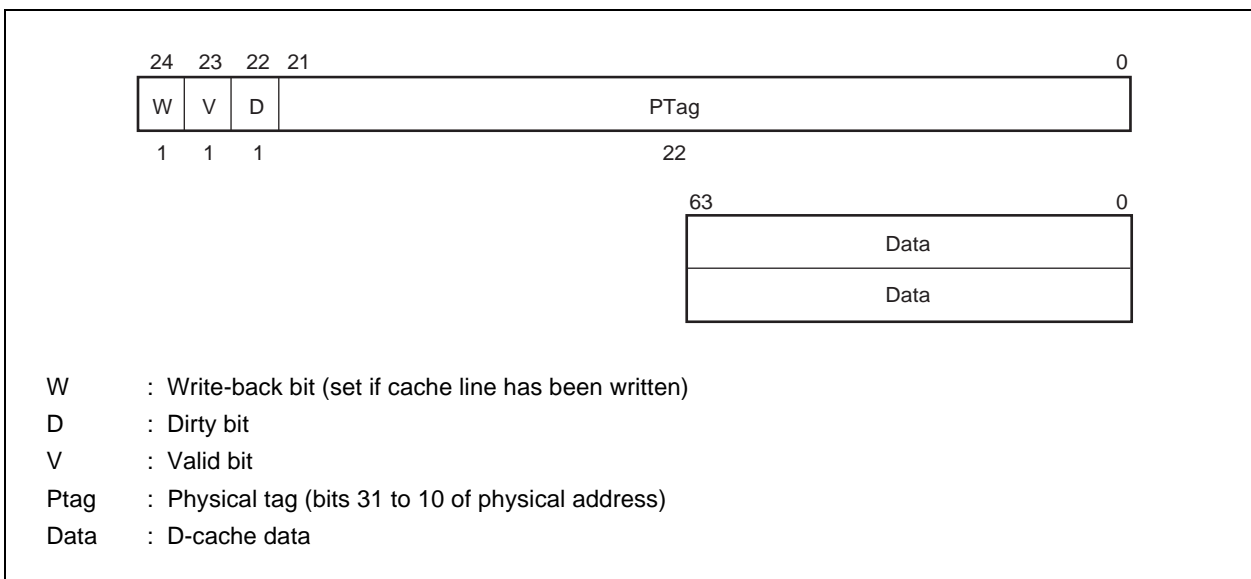

9.2.3 Accessing the caches

Figure 9-5 shows the virtual address (VA) index into the caches. The number of virtual address bits used to index the instruction and data caches depends on the cache size.

(1) Data cache addressing

Using VA (11:4). The most-significant bit is VA11 because the cache size is 4 Kbytes.

The least-significant bit is VA4 because the line size is 4 words (16 bytes).

(2) Instruction cache addressing

Using VA (11:4). The most-significant bit is VA11 because the cache size is 4 Kbytes.

The least-significant bit is VA4 because the line size is 4 words (16 bytes).

Figure 9-5. Cache Data and Tag Organization

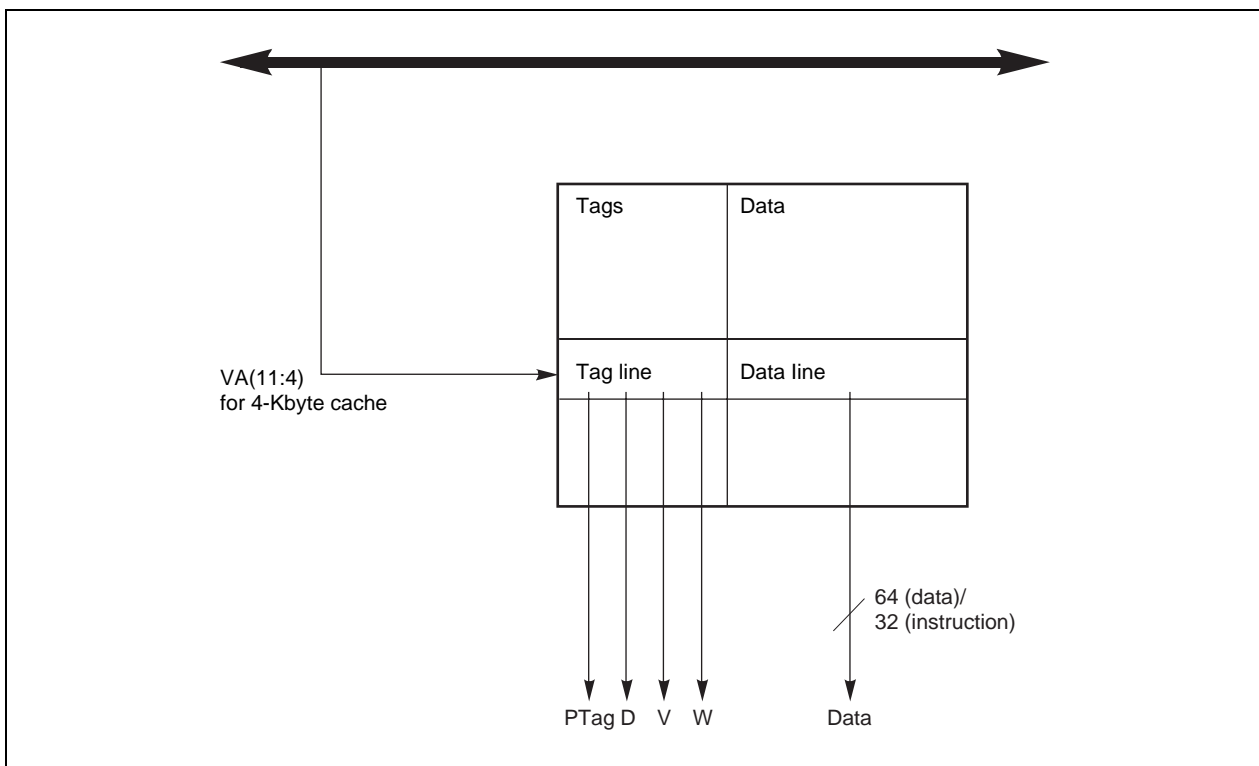

9.3 Cache Operations

As described earlier, caches provide fast temporary data storage, and they make the speedup of memory accesses transparent to the user. In general, the CPU core accesses cache-resident instructions or data through the following procedure:

1. The CPU core, through the on-chip cache controller, attempts to access the next instruction or data in the appropriate cache.
2. The cache controller checks to see if this instruction or data is present in the cache.
 - If the instruction/data is present, the CPU core retrieves it. This is called a cache hit.
 - If the instruction/data is not present in the cache, the cache controller must retrieve it from memory. This is called a cache miss.
3. The CPU core retrieves the instruction/data from the cache and operation continues.

It is possible for the same data to be in two places simultaneously: main memory and cache. This data is kept consistent through the use of a write-back methodology; that is, modified data is not written back to memory until the cache line is to be replaced.

Instruction and data cache line replacement operations are described in the following sections.

9.3.1 Cache write policy

The VR4110 CPU core manages its data cache by using a write-back policy; that is, it stores write data into the cache, instead of writing it directly to memory^{Note}. Some time later this data is independently written into memory. In the VR4181 implementation, a modified cache line is not written back to memory until the cache line is to be replaced either in the course of satisfying a cache miss, or during the execution of a write-back CACHE instruction.

When the CPU core writes a cache line back to memory, it does not ordinarily retain a copy of the cache line, and the state of the cache line is changed to invalid.

Note Contrary to the write-back, the write-through cache policy stores write data into the memory and cache simultaneously.

9.4 Cache States

(1) Cache line

The three terms below are used to describe the state of a cache line:

- Dirty: a cache line containing data that has changed since it was loaded from memory.
- Clean: a cache line that contains data that has not changed since it was loaded from memory.
- Invalid: a cache line that does not contain valid information must be marked invalid, and cannot be used. For example, after a Soft Reset, software sets all cache lines to invalid. A cache line in any other state than invalid is assumed to contain valid information. Neither Cold Reset nor Soft Reset makes the cache state invalid. Software makes the cache state invalid.

(2) Data cache

The data cache supports three cache states:

- invalid
- valid clean
- valid dirty

(3) Instruction cache

The instruction cache supports two cache states:

- invalid
- valid

The state of a valid cache line may be modified when the processor executes a CACHE operation. CACHE operations are described in **CHAPTER 27 MIPS III INSTRUCTION SET DETAILS**.

9.5 Cache State Transition Diagrams

The following section describes the cache state diagrams for the data and instruction cache lines. These state diagrams do not cover the initial state of the system, since the initial state is system-dependent.

9.5.1 Data cache state transition

The following diagram illustrates the data cache state transition sequence. A load or store operation may include one or more of the atomic read and/or write operations shown in the state diagram below, which may cause cache state transitions.

- Read (1) indicates a read operation from main memory to cache, inducing a cache state transition.
- Write (1) indicates a write operation from CPU core to cache, inducing a cache state transition.
- Read (2) indicates a read operation from cache to the CPU core, which induces no cache state transition.
- Write (2) indicates a write operation from CPU core to cache, which induces no cache state transition.

Figure 9-6. Data Cache State Diagram

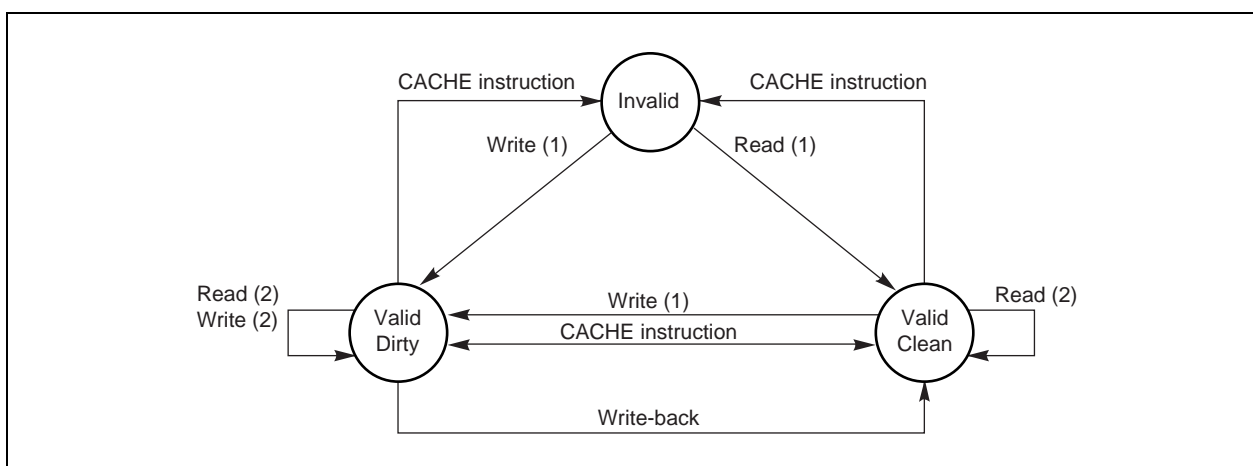

9.5.2 Instruction cache state transition

The following diagram illustrates the instruction cache state transition sequence.

- Read (1) indicates a read operation from main memory to cache, inducing a cache state transition.
- Read (2) indicates a read operation from cache to the CPU core, which induces no cache state transition.

Figure 9-7. Instruction Cache State Diagram

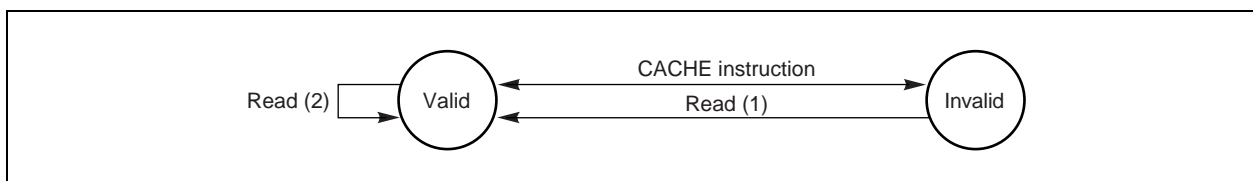

9.6 Cache Data Integrity

Figures 9-8 to 9-22 shows checking operations for various cache accesses.

Figure 9-8. Data Check Flow on Instruction Fetch

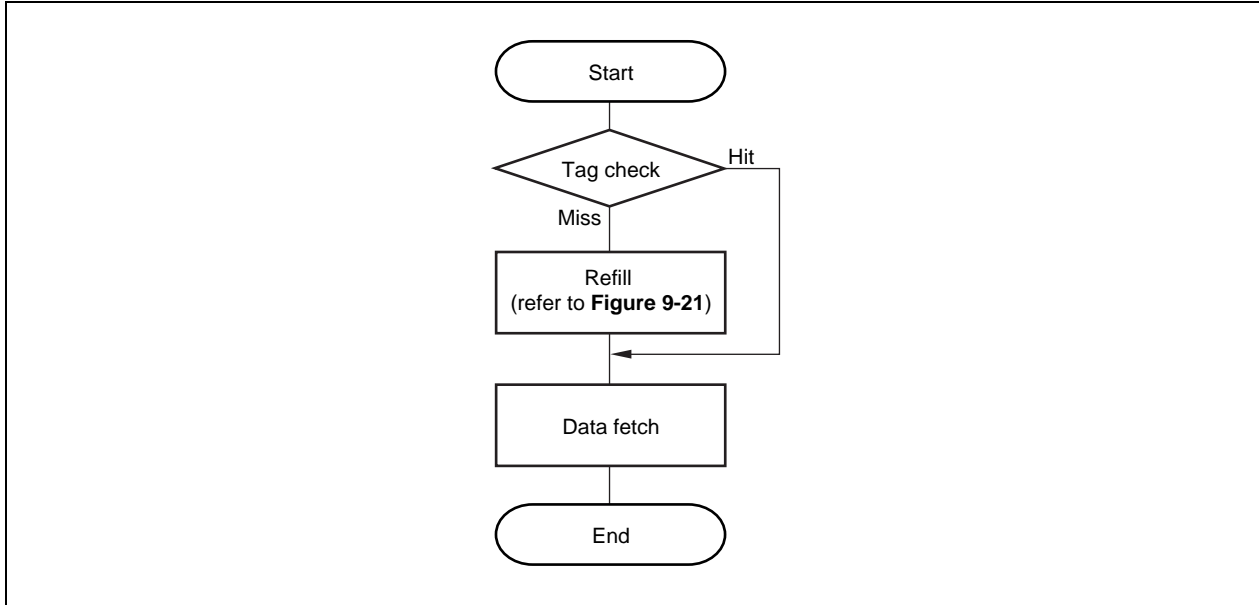

Figure 9-9. Data Check Flow on Load Operations

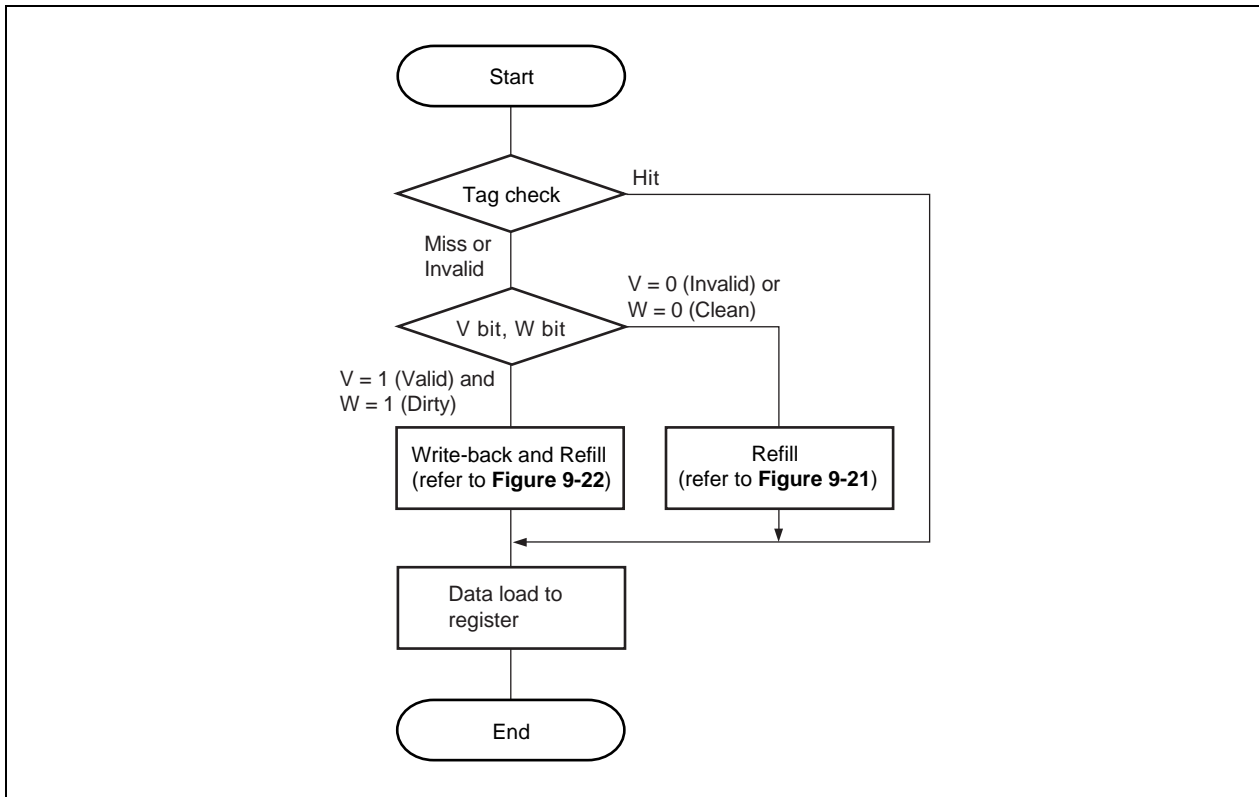

Figure 9-10. Data Check Flow on Store Operations

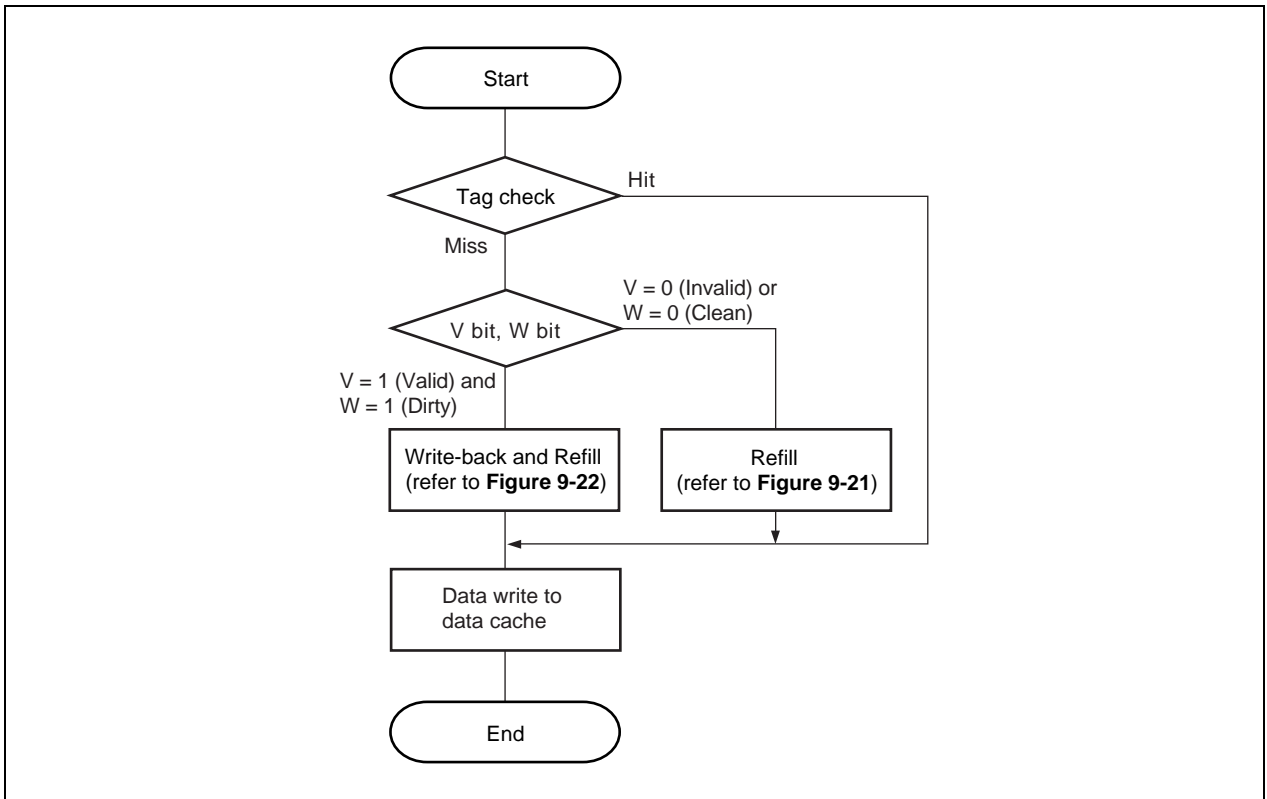

Figure 9-11. Data Check Flow on Index_Invalidate Operations

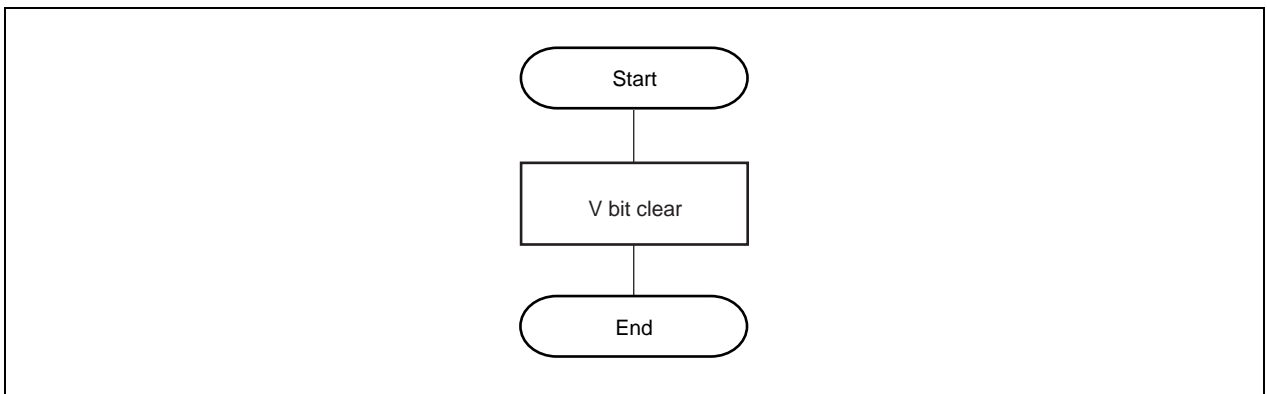

Figure 9-12. Data Check Flow on Index_Writeback_Invalidate Operations

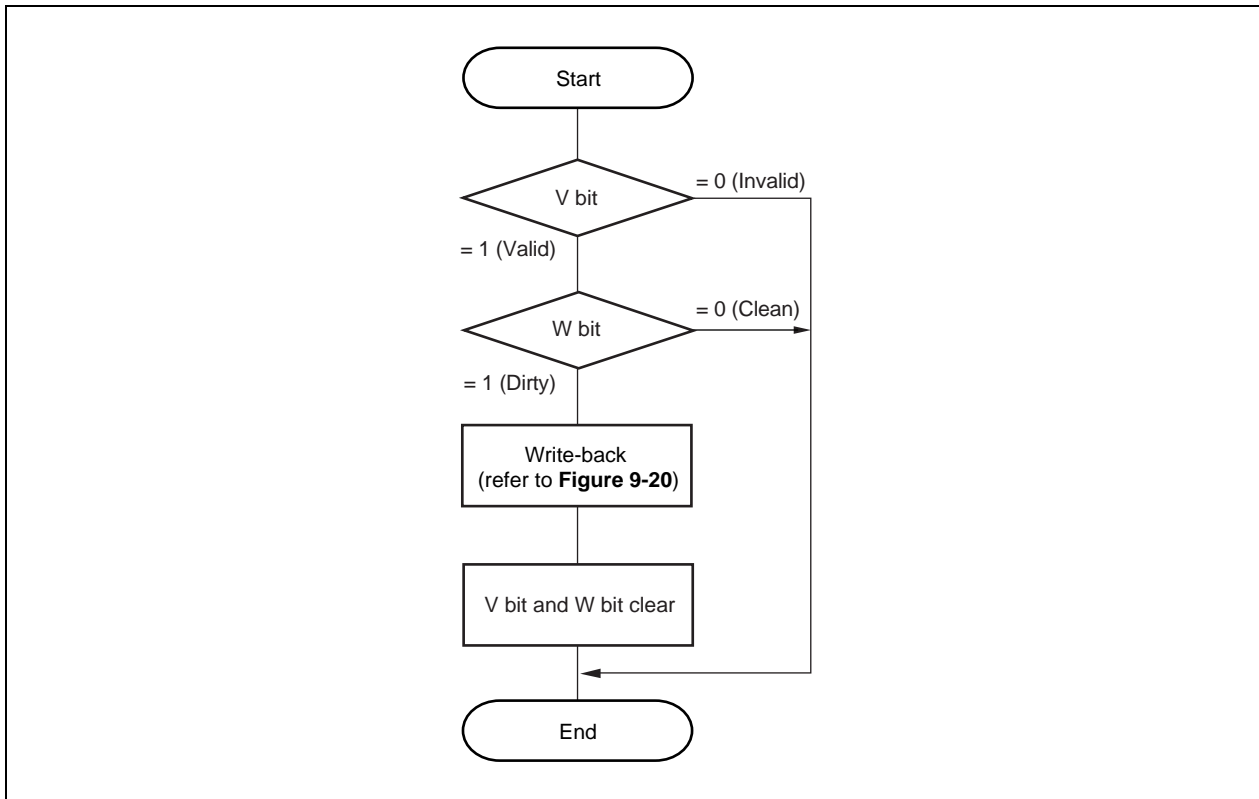

Figure 9-13. Data Check Flow on Index_Load_Tag Operations

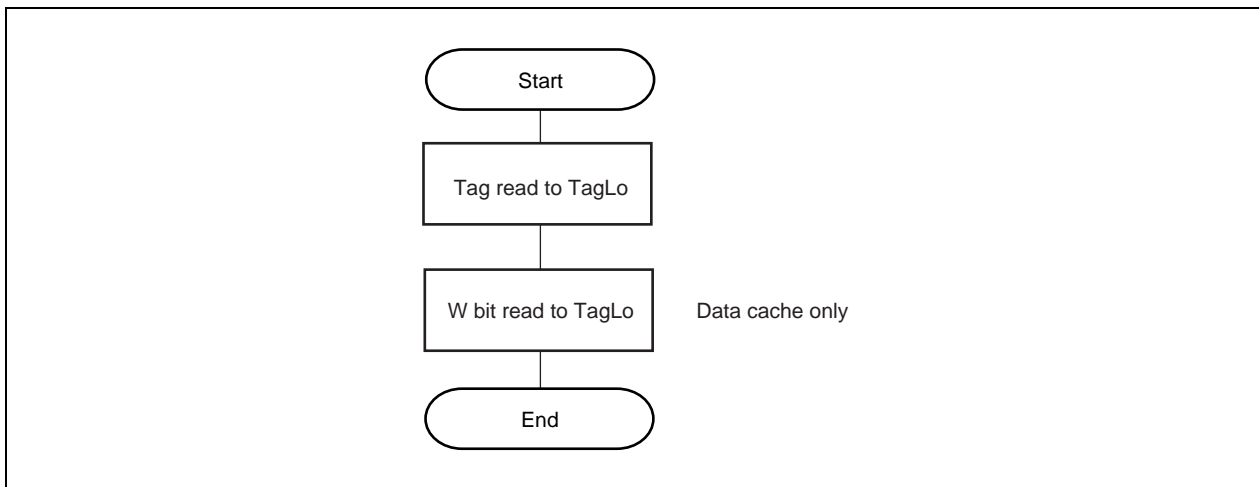

Figure 9-14. Data Check Flow on Index_Store_Tag Operations

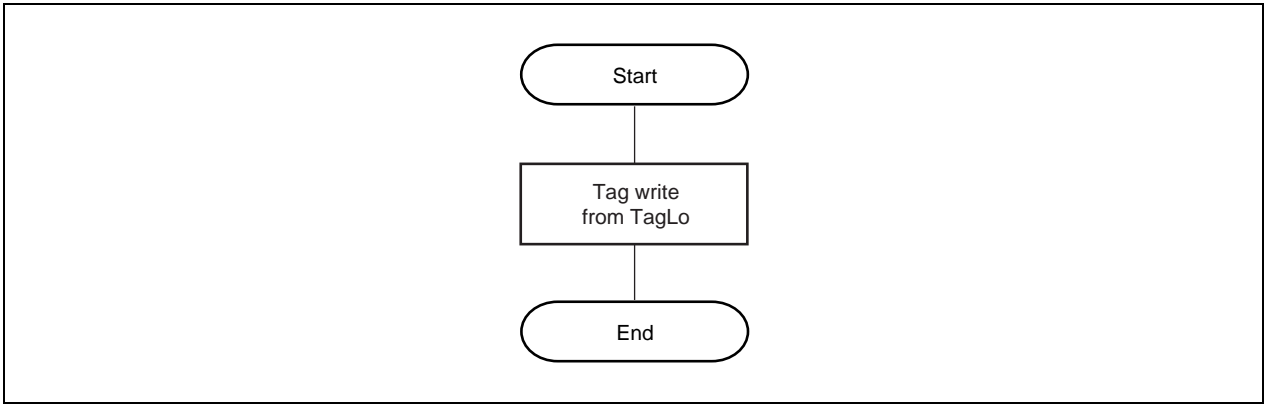

Figure 9-15. Data Check Flow on Create_Dirty Operations

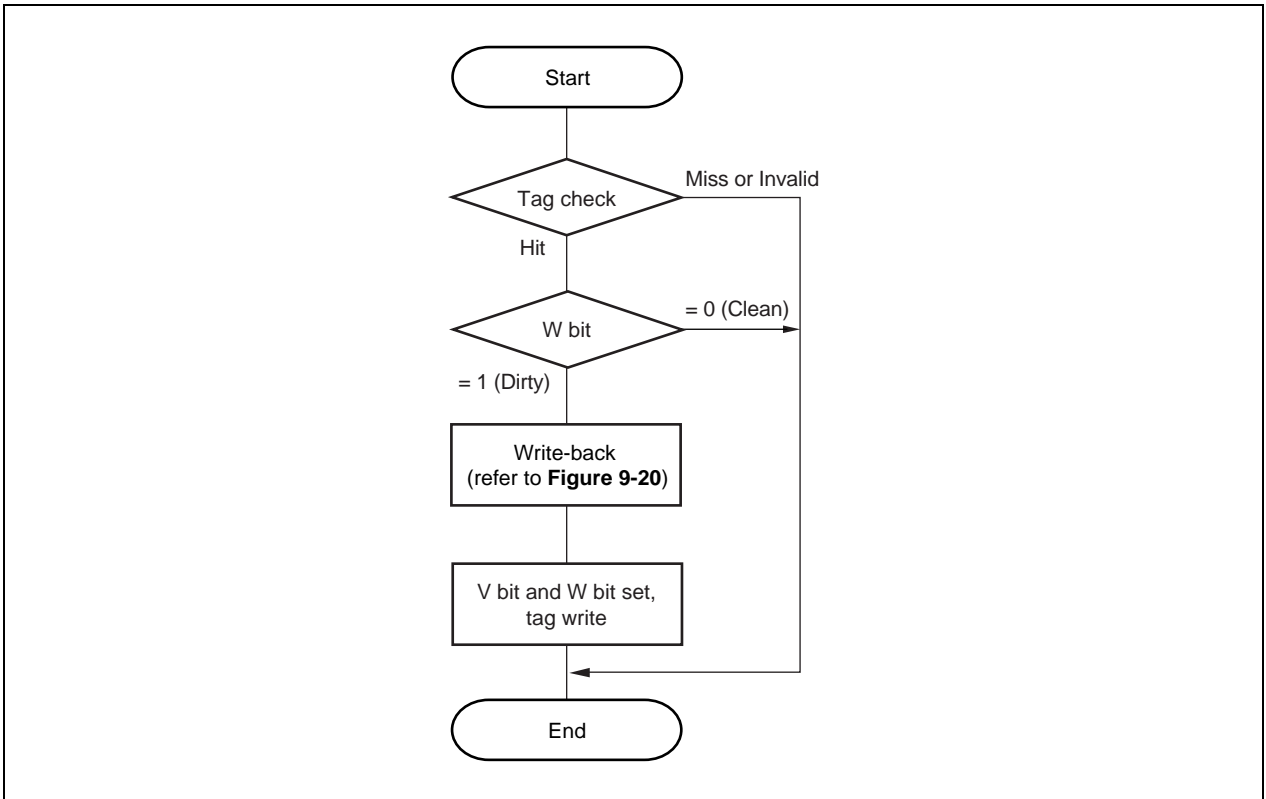

Figure 9-16. Data Check Flow on Hit_Invalidate Operations

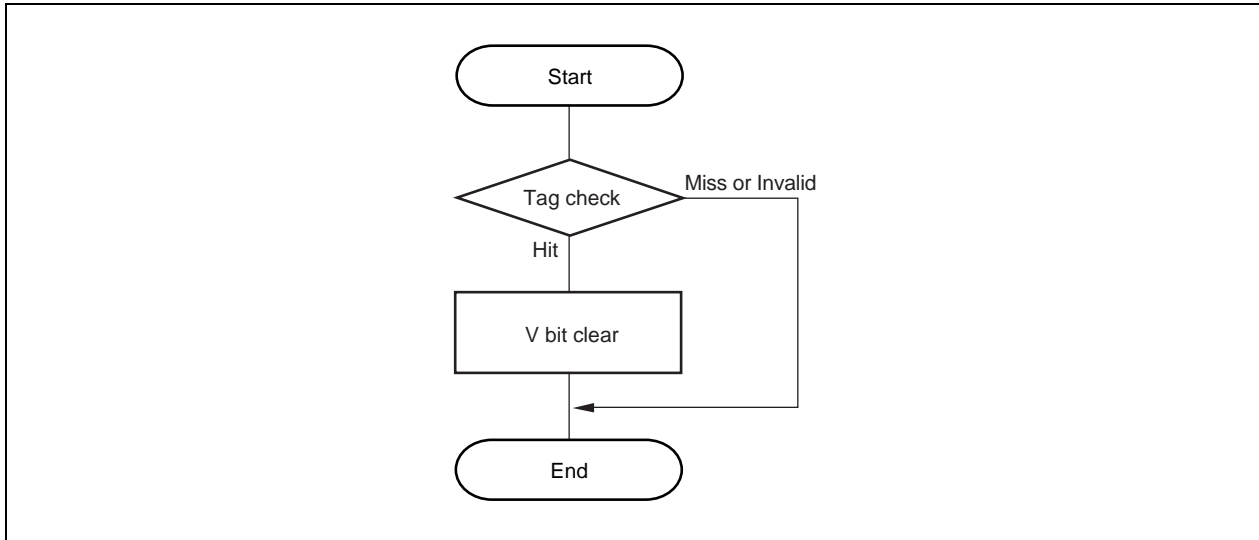

Figure 9-17. Data Check Flow on Hit_Writeback_Invalidate Operations

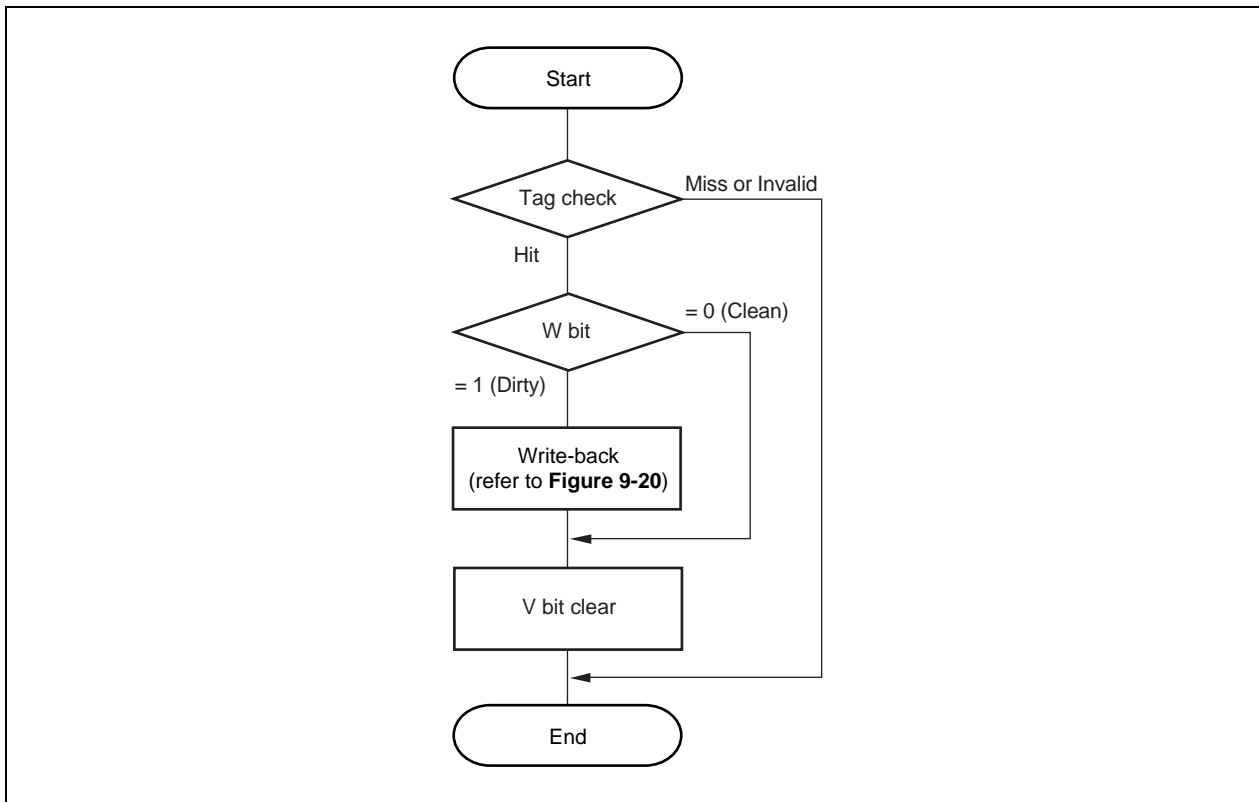

Figure 9-18. Data Check Flow on Fill Operations

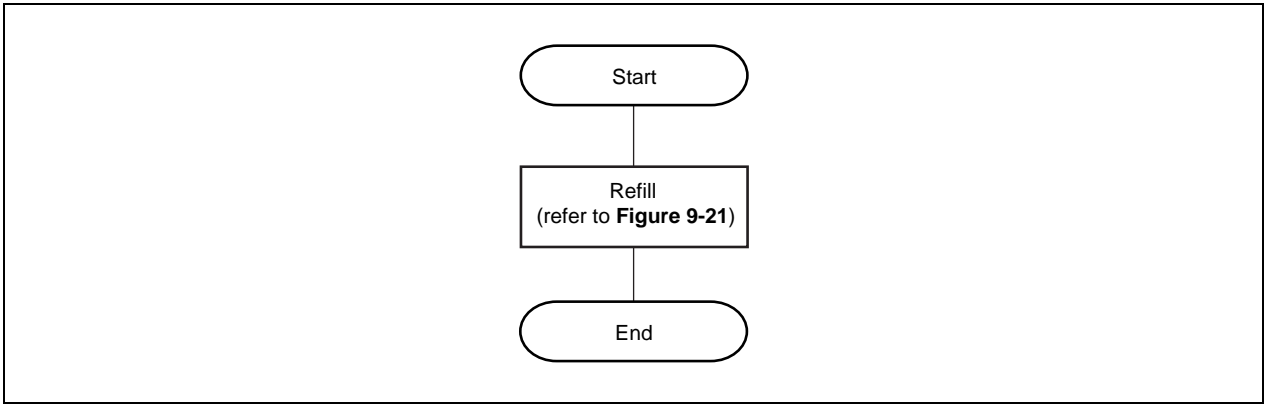

Figure 9-19. Data Check Flow on Hit_Writeback Operations

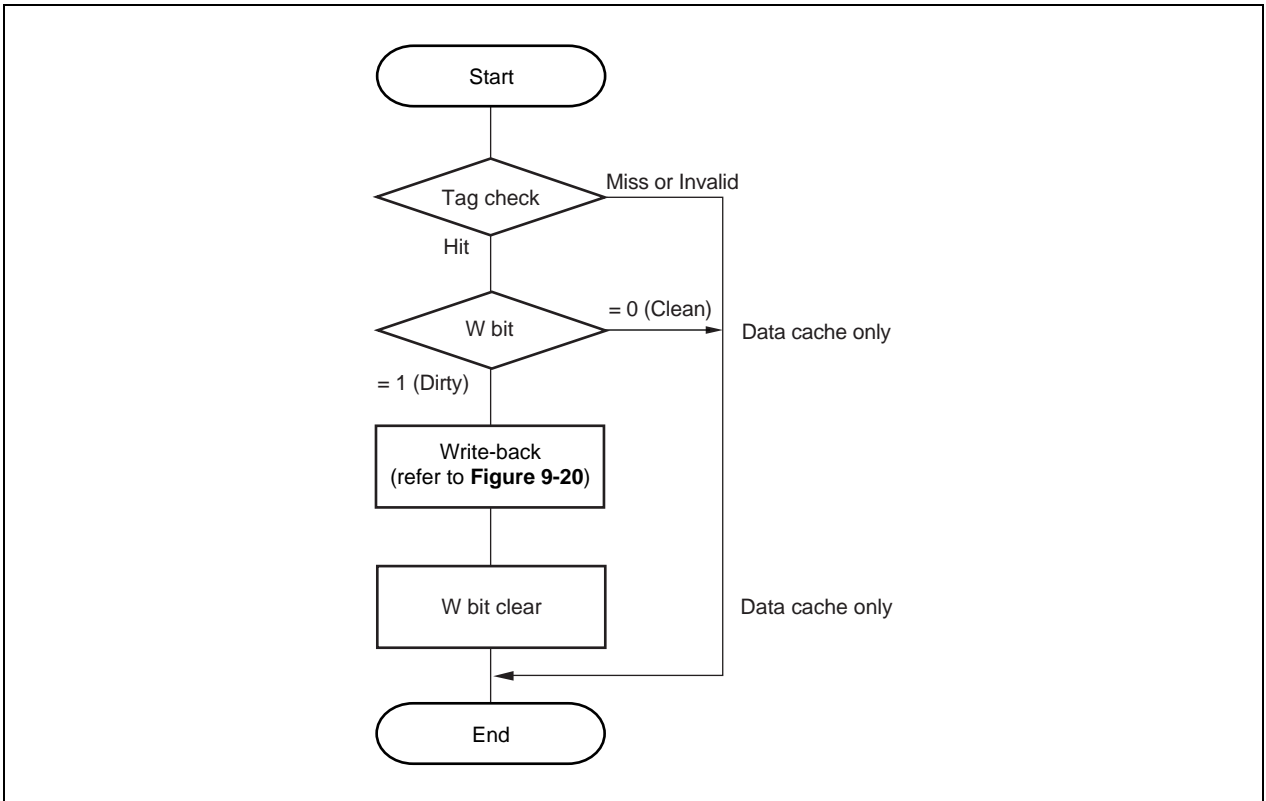

Figure 9-20. Writeback Flow

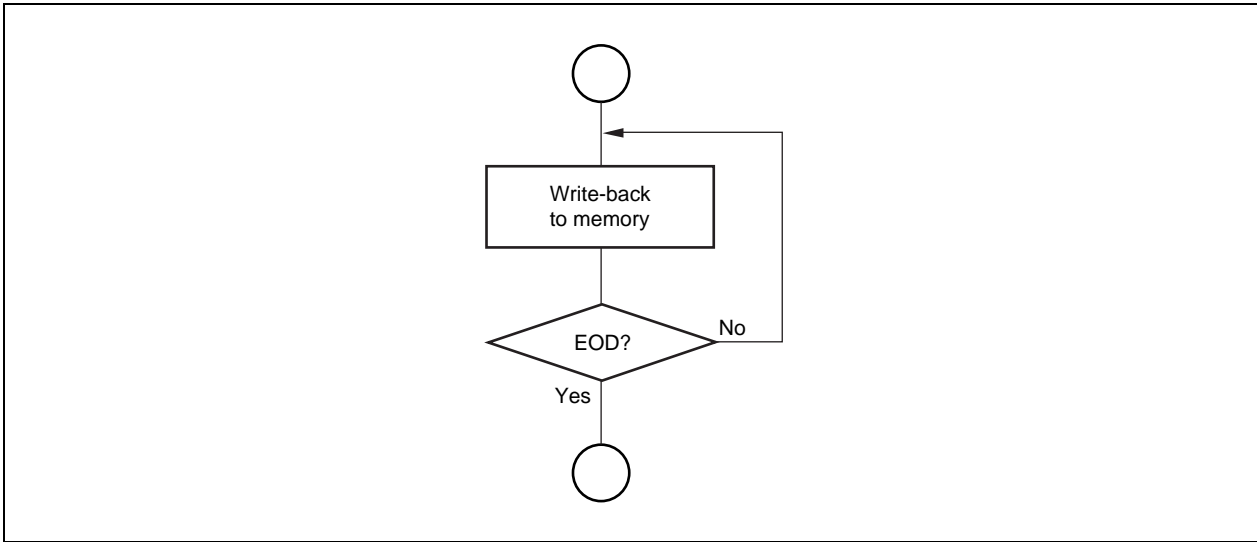

Figure 9-21. Refill Flow

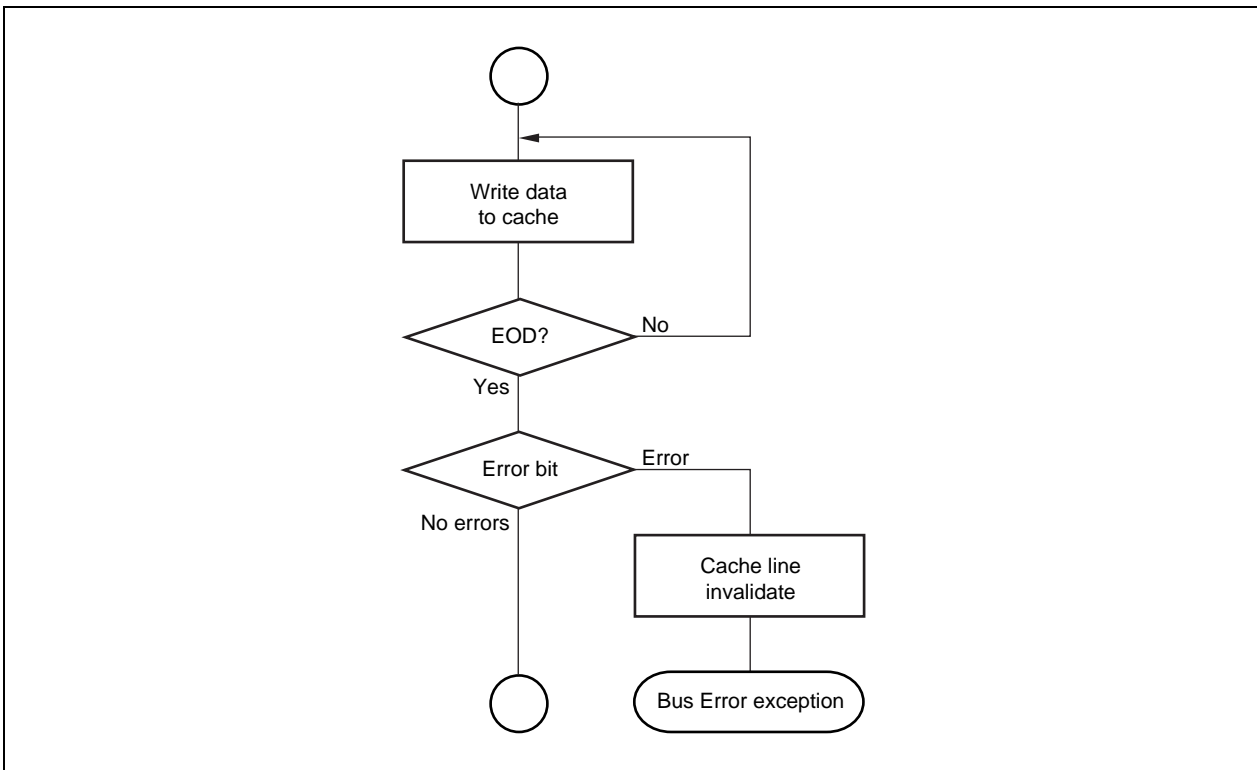
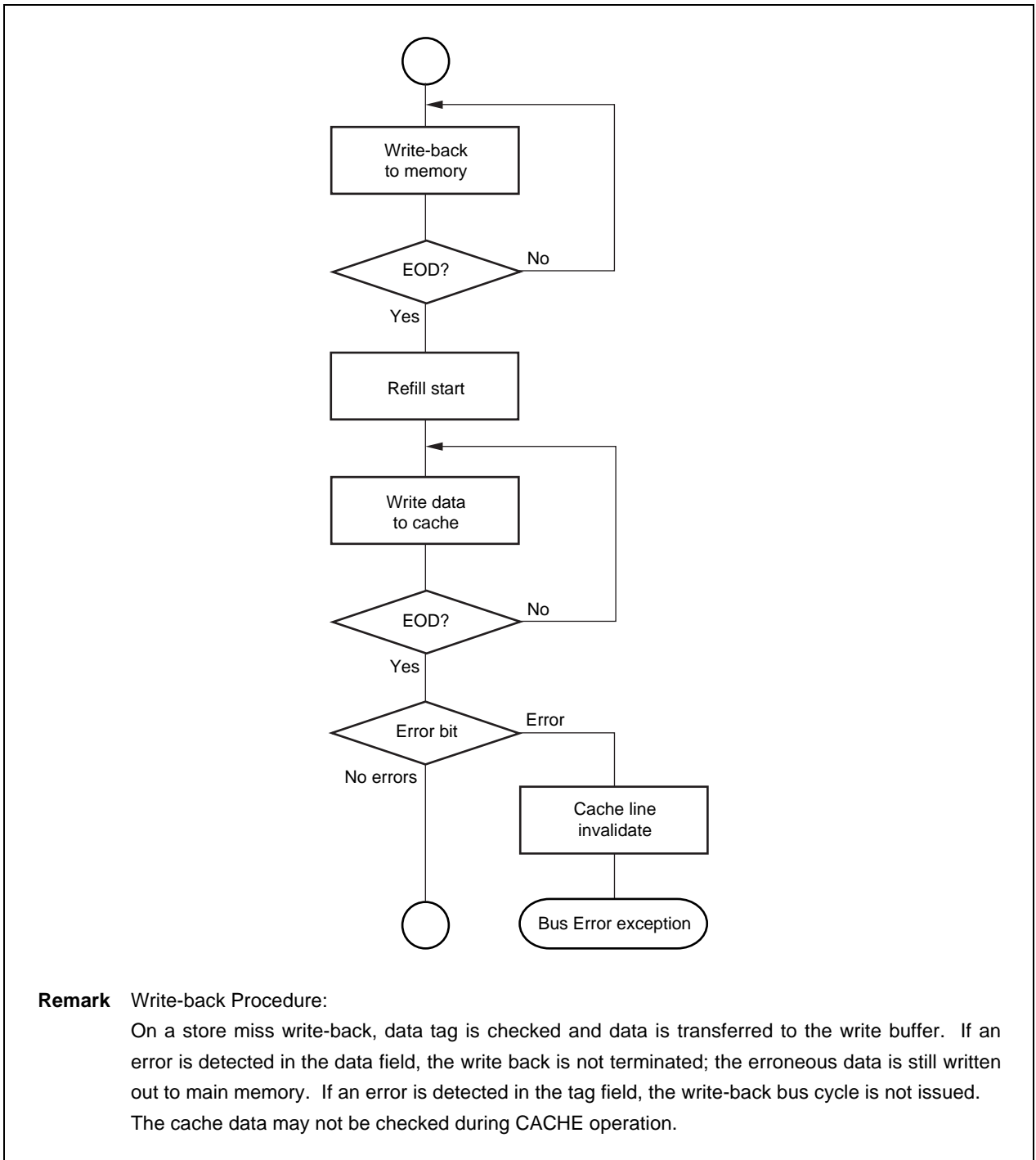

Figure 9-22. Writeback & Refill Flow

**Remark** Write-back Procedure:

On a store miss write-back, data tag is checked and data is transferred to the write buffer. If an error is detected in the data field, the write back is not terminated; the erroneous data is still written out to main memory. If an error is detected in the tag field, the write-back bus cycle is not issued. The cache data may not be checked during CACHE operation.

9.7 Manipulation of the Caches by an External Agent

The Vr4181 does not provide any mechanisms for an external agent to examine and manipulate the state and contents of the caches.

CHAPTER 10 CPU CORE INTERRUPTS

Four types of interrupt are available on the CPU core. These are:

- one non-maskable interrupt, NMI
- five ordinary interrupts
- two software interrupts
- one timer interrupt

For the interrupt request input to the CPU core, see **CHAPTER 14 INTERRUPT CONTROL UNIT (ICU)**.

10.1 Non-maskable Interrupt (NMI)

The non-maskable interrupt is acknowledged by asserting the NMI signal (internal), forcing the processor to branch to the Reset Exception vector. This signal is latched into an internal register at the rising edge of MasterOut, as shown in Figure 10-1.

NMI only takes effect when the processor pipeline is running.

This interrupt cannot be masked.

Figure 10-1 shows the internal service of the NMI signal. The NMI signal is latched into an internal register by the rising edge of MasterOut. The latched signal is inverted to be transferred to inside the device as an NMI request.

Figure 10-1. Non-maskable Interrupt Signal

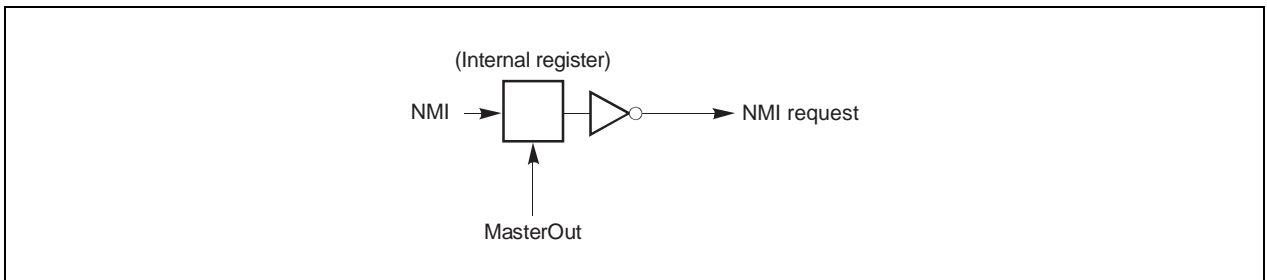

10.2 Ordinary Interrupts

Ordinary interrupts are acknowledged by asserting the Int(4:0) signals (internal). **However, Int4 never occurs in the Vr4181.**

This interrupt request can be masked with the IM (6:2), IE, and EXL fields of the Status register.

10.3 Software Interrupts Generated in CPU Core

Software interrupts generated in the CPU core use bits 1 and 0 of the IP (interrupt pending) field in the Cause register. These may be written by software, but there is no hardware mechanism to set or clear these bits.

After the processing of a software interrupt exception, corresponding bit of the IP field in the Cause register must be cleared before returning to ordinary routine or enabling multiple interrupts until the operation returns to normal routine.

This interrupt request is maskable through the IM (1:0), IE, and EXL fields of the Status register.

10.4 Timer Interrupt

The timer interrupt uses bit 7 of the IP (interrupt pending) field of the Cause register. This bit is set automatically whenever the value of the Count register equals the value of the Compare register, and an interrupt request is acknowledged.

This interrupt is maskable through IM7 of the IM field of the Status register.

10.5 Asserting Interrupts

10.5.1 Detecting hardware interrupts

Figure 10-2 shows how the hardware interrupts are readable through the Cause register.

- The timer interrupt signal, IP7, is directly readable as bit 15 of the Cause register.
- Bits 4:0 of the Interrupt register are bit-wise ORed with the current value of the Int(4:0) signals and the result is directly readable as bits 14:10 of the Cause register.

IP(1:0) of the Cause register, which are described in Chapter 7, are software interrupts. There is no hardware mechanism for setting or clearing the software interrupts.

Figure 10-2. Hardware Interrupt Signals

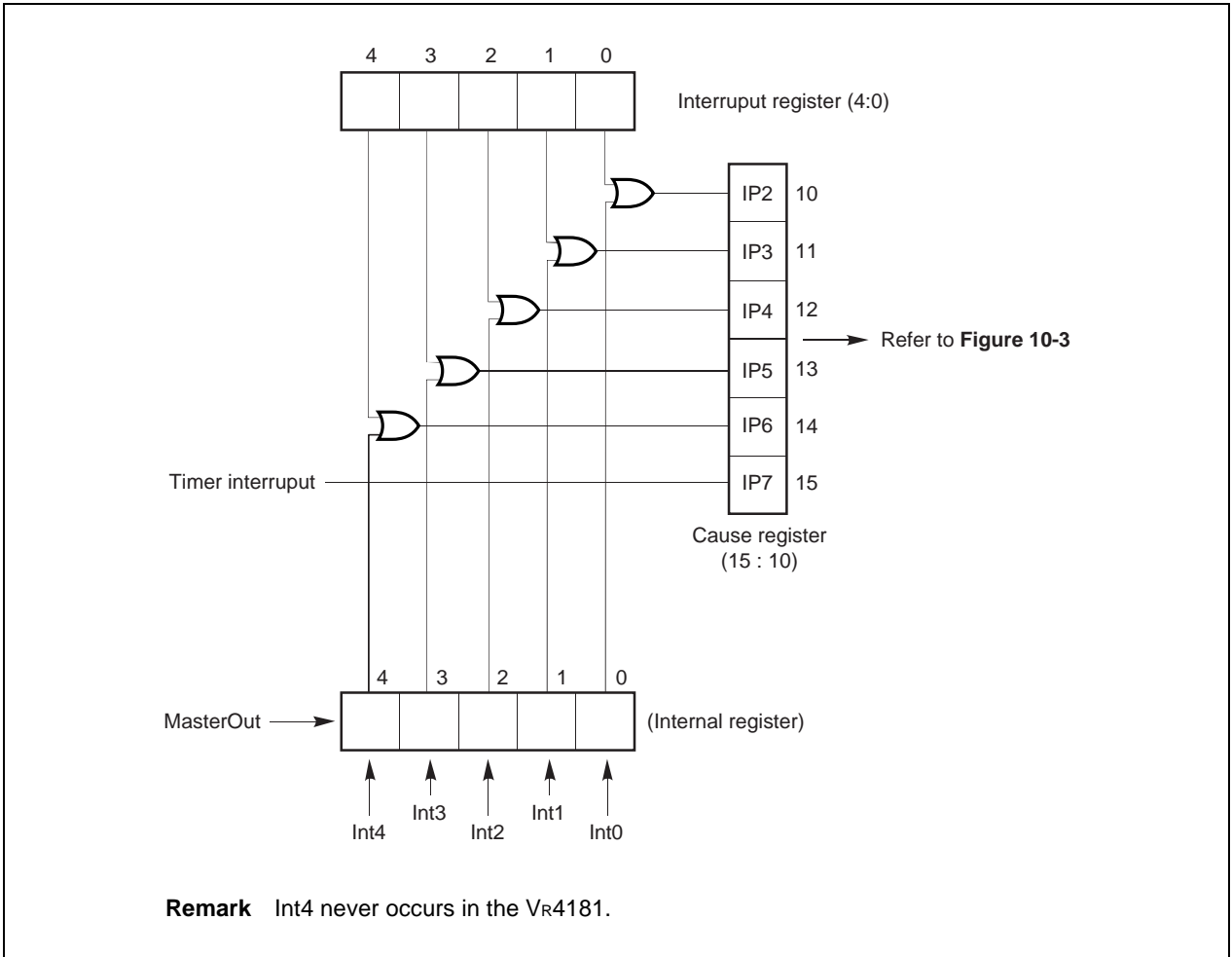

10.5.2 Masking interrupt signals

Figure 10-3 shows the masking of the CPU core interrupt signals.

- Cause register bits 15 to 8 (IP7 to IP0) are AND-ORed with Status register interrupt mask bits 15 to 8 (IM7 to IM0) to mask individual interrupts.
- Status register bit 0 is a global Interrupt Enable (IE). It is ANDed with the output of the AND-OR logic to produce the CPU core interrupt signal. The EXL bit in the Status register also enables these interrupts.

Figure 10-3. Masking of the Interrupt Request Signals

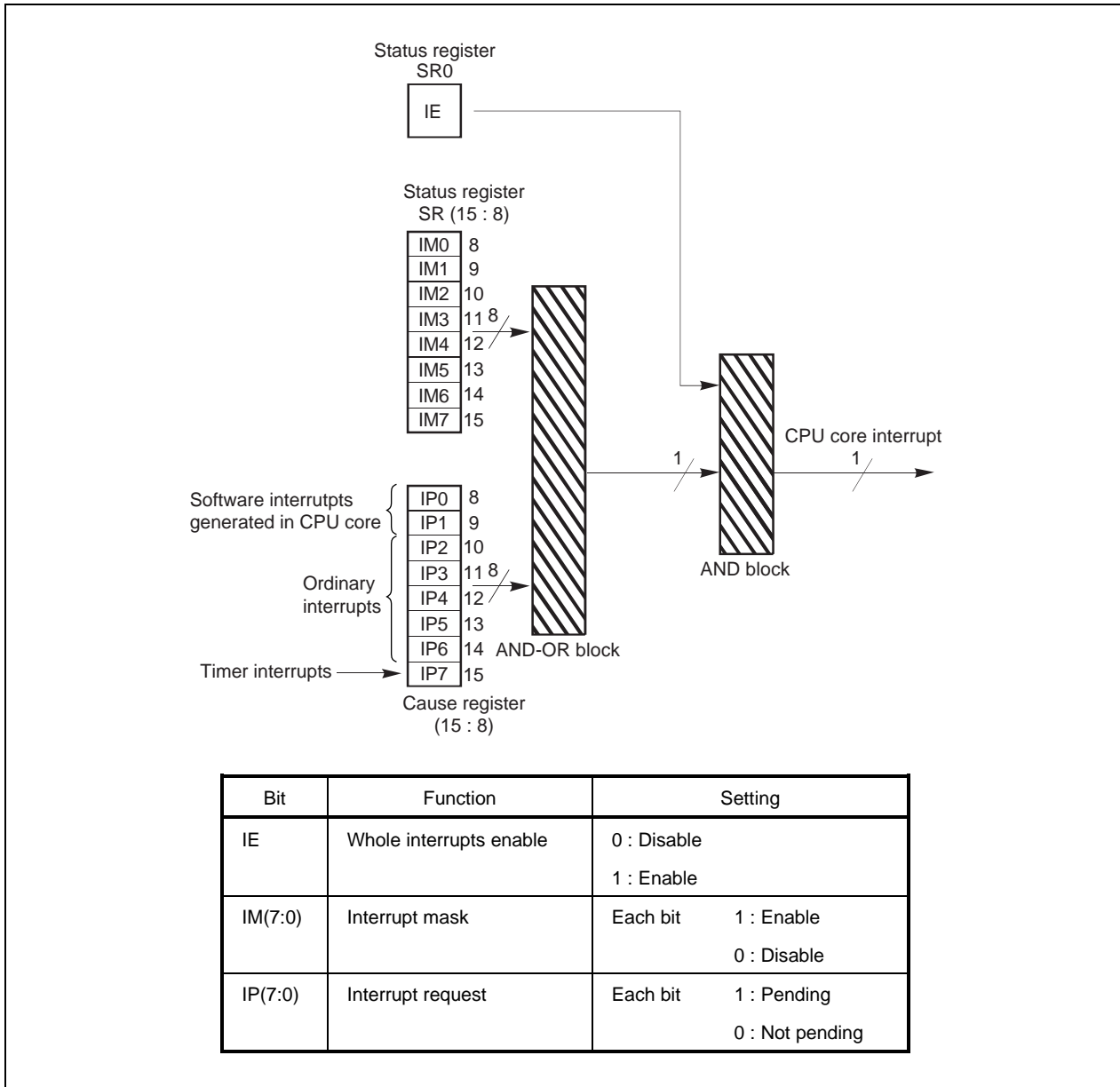

CHAPTER 11 BUS CONTROL

11.1 MBA Host Bridge

The MBA (Modular Bus Architecture) Host Bridge is an interface between the CPU core and the MBA bus and operates as an external agent to the CPU core. It handles all requests from the CPU core if it is provided proper resources. The MBA Host Bridge can decode the entire physical address space to start appropriate bus accesses such as MBA requests, MBA - ISA protocols, or external ROM accesses through the peripheral bus. It also has functions as a host bridge to implement proper cycle timings and bus transaction protocols.

Figure 11-1. VR4181 Internal Bus Structure

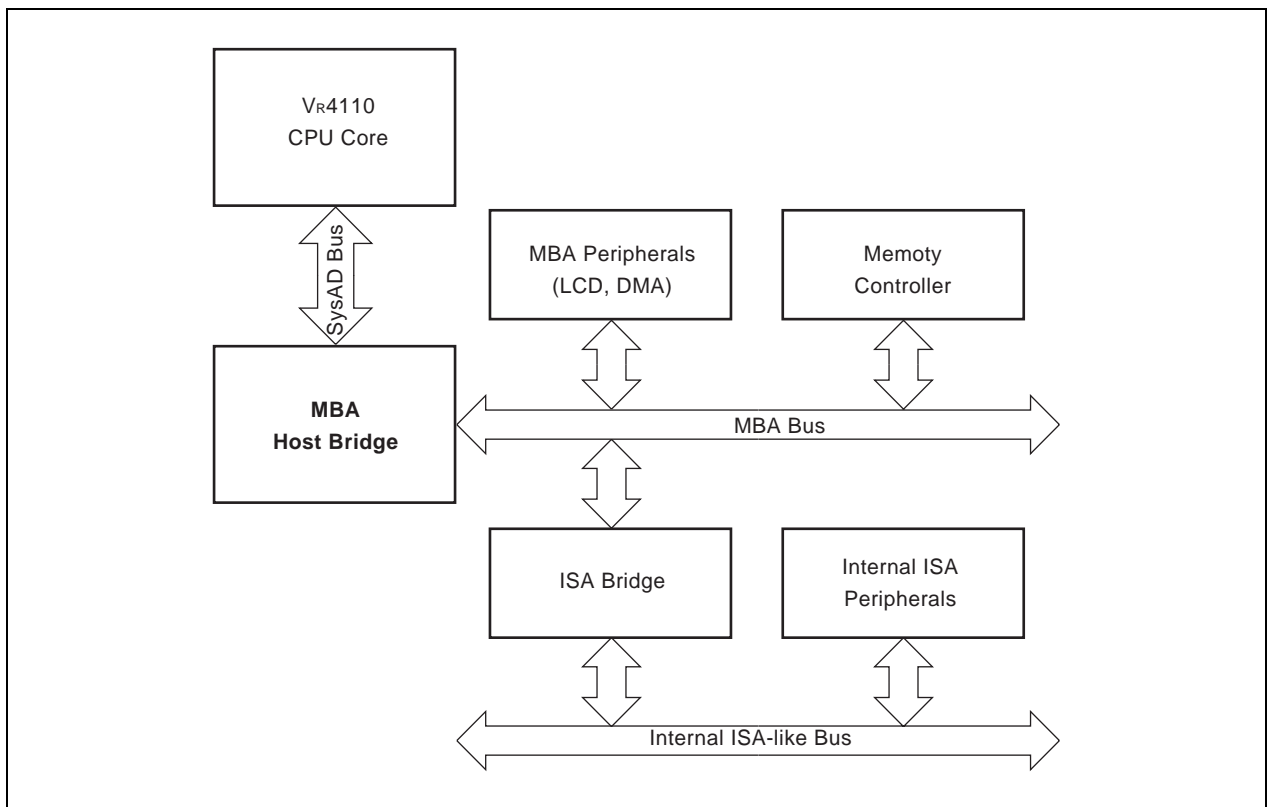

11.1.1 MBA Host Bridge ROM and register address space

Physical address	Type	Device
0x1FFF FFFF to 0x1800 0000	Memory (range)	ROM
0x0A00 0014 to 0x0A00 0000	I/O (range)	Bus Control registers
0x0A00 0080	I/O	Interrupt register
0x0A00 008C	I/O	Interrupt register
0x0A00 0098	I/O	Interrupt register
0x0A00 009A	I/O	Interrupt register
0x0A00 0200	I/O	Interrupt register
0x0A00 0206	I/O	Interrupt register

In addition to the decoding of above addresses, the Host Bridge generates MBA select signals if other MBA masters want to access the above devices. The Host Bridge responds to the above addresses only upon a CPU access. For any other addresses the Host Bridge initiates an MBA cycle.

11.1.2 MBA modules address space

(1) Memory controller

Physical address	Type	Device
0x03FF FFFF to 0x0000 0000	Memory (range)	DRAM
0x0A0 003FF to 0x0A00 0300	I/O (range)	Control registers

The MBA memory controller returns an MBA select signal upon a decoding of the above address ranges.

(2) DMA controller

Physical address	Type	Device
0x0A00 0048 to 0x0A00 0020	I/O (range)	Control registers 1
0x0A00 06FF to 0x0A00 0600	I/O (range)	Control registers 2

The MBA DMA controller returns an MBA select signal upon a decoding of the above I/O ranges.

(3) LCD module (LCD Control Unit)

Physical address	Type	Device
0x0A00 05FF to 0x0000 0400	I/O (Range)	Control registers

The LCD module returns an MBA select signal upon a decoding of the above I/O range.

(4) ISA Bridge

Physical address	Type	Device
0x17FF FFFF to 0x1400 0000	I/O (64M, range)	External ISA bus (I/O)
0x13FF FFFF to 0x1000 0000	Memory (64M, range)	External ISA bus (Memory)
0x0BFF FFFF to 0x0B00 0000	I/O (16M, range)	ISA internal I/O 1
0x0CFF FFFF to 0x0C00 0000	I/O (16M, range)	ISA internal I/O 2

The ISA Bridge returns an MBA select signal upon a decoding of the above address ranges.

11.2 Bus Control Registers

The MBA Host Bridge contains the BCU registers and the clock mask register of the Vr4102 (note that their addresses are changed from the Vr4102). External ROM accesses and supply of clocks to several internal units are controlled by these registers. The bus control registers are listed below.

Table 11-1. Bus Control Registers

Physical address	R/W	Register symbol	Function
0x0A00 0000	R/W	BCUCNTREG1	BCU control register 1
0x0A00 0004	R/W	CMUCLKMSK	Clock mask register
0x0A00 000C	R/W	BCUSPEEDREG	BCU access time parameter
0x0A00 0010	R/W	BCURFCNTREG	BCU refresh control register
0x0A00 0014	R	REVIDREG	Revision ID register
0x0A00 0018	R	CLKSPEEDREG	Clock speed register

Caution Since these registers are powered by 2.5 V power supply, the contents of these registers are cleared after Hibernate mode

11.2.1 BCUCNTREG 1 (0x0A00 0000)

Bit	15	14	13	12	11	10	9	8
Name	ROMs1	ROMs0	Reserved	Reserved	Reserved	Reserved	Reserved	Reserved
R/W	R/W	R/W	R	R	R	R	R	R
At reset	1	0	0	0	0	0	0	0

Bit	7	6	5	4	3	2	1	0
Name	Reserved	Reserved	Reserved	ROMWEN0	Reserved	Rtype1	Rtype0	RSTOUT
R/W	R	R	R	R/W	R	R/W	R/W	R/W
At reset	0	0	0	0	0	0	0	0

Bit	Name	Function
15, 14	ROMs(1:0)	Defines ROM size to be used 00 : Reserved 01 : 32 Mbit 10 : 64 Mbit 11 : Reserved
13 to 5	Reserved	0 is returned when read
4	ROMWEN0	This bit enables flash ROM write for bank 0, bank1, bank2, and bank3 0 : Disabled 1 : Enable (Not affected by PAGEROM0 bit)
3	Reserved	0 is returned when read
2, 1	Rtype(1:0)	ROM type 00 : Ordinary ROM 01 : Flash memory 10 : Page ROM 11 : Reserved
0	RSTOUT	RESET# output control. This bit does not affect GPIO21/RESET# pin's state when this pin is not defined as RESET# output. 0 : RESET# is active (Low level) 1 : RESET# is inactive (High level)

This register is used to set ROM type and capacity of ROM Bank 0, 1, 2 and 3.

11.2.2 CMUCLKMSK (0x0A00 0004)

Bit	15	14	13	12	11	10	9	8
Name	Reserved	Reserved	Reserved	Reserved	Reserved	Reserved	Reserved	Reserved
R/W	R	R	R	R	R	R	R	R
At reset	0	0	0	0	0	0	0	0

Bit	7	6	5	4	3	2	1	0
Name	Reserved	MSKCSU PCLK	MSKAIU PCLK	MSKPIU PCLK	MSKADU PCLK	MSKSIU 18M	MSKADU 18M	Reserved
R/W	R	R/W	R/W	R/W	R/W	R/W	R/W	R/W
At reset	0	0	0	0	0	0	0	0

Bit	Name	Function
15 to 7	Reserved	0 is returned when read
6	MSKCSUPCLK	Supply/Mask Clocked Serial Interface (CSI) peripheral clock (PCLK) 0 : Mask 1 : Supply
5	MSKAIUPCLK	Supply/Mask Audio Interface (AIU) peripheral clock (PCLK) 0 : Mask 1 : Supply
4	MSKPIUPCLK	Supply/Mask Touch Panel Interface (PIU) peripheral clock (PCLK) 0 : Mask 1 : Supply
3	MSKADUPCLK	Supply/Mask A/D converter and D/A converter peripheral clock (PCLK) 0 : Mask 1 : Supply
2	MSKSIU18M	Supply/Mask Serial Interface 1 and 2 (SIU1/SIU2) 18.432MHz clock 0 : Mask 1 : Supply
1	MSKADU18M	Supply/Mask A/D converter and D/A converter 18.432MHz clock 0 : Mask 1 : Supply
0	Reserved	Write 0 when write. 0 is returned when read.

This register is used to mask the clocks that are supplied to CSI, AIU, PIU, SIU1 and SIU2.

11.2.3 BCUSPEEDREG (0x0A00 000C)

Bit	15	14	13	12	11	10	9	8
Name	Reserved	WPROM2	WPROM1	WPROM0	Reserved	Reserved	Reserved	Reserved
R/W	R	R/W	R/W	R/W	R	R	R	R
At reset	0	1	1	1	0	0	0	0

Bit	7	6	5	4	3	2	1	0
Name	Reserved	Reserved	Reserved	Reserved	WROMA3	WROMA2	WROMA1	WROMA0
R/W	R	R	R	R	R	R/W	R/W	R/W
At reset	0	0	0	0	1	1	1	1

Bit	Name	Function
15	Reserved	0 is returned when read
14 to 12	WPROM(2:0)	Page ROM access speed 000 : 1 TClock 001 : 2 TClock 010 : 3 TClock 011 : 4 TClock 100 : 5 TClock 101 : 6 TClock 110 : 7 TClock 111 : 8 TClock
11 to 4	Reserved	0 is returned when read
3 to 0	WROMA(3:0)	ROM access speed 0000 : 1 TClock 0001 : 2 TClock 0010 : 3 TClock 0011 : 4 TClock 0100 : 5 TClock 0101 : 6 TClock 0110 : 7 TClock 0111 : 8 TClock 1000 : 9 TClock 1001 : 10 TClock 1010 : 11 TClock 1011 : 12 TClock 1100 : 13 TClock 1101 : 14 TClock 1110 : 15 TClock 1111 : 16 TClock

This register is used to set ROM access parameter of Bank 0, 1, 2, and 3. About the relationship between these bits and ROM cycles, refer to **Figure 11-2. ROM Read Cycle**.

Remark The external PageROM is accessed in 8 words (1 word = 16 bits) for one cache line.

Figure 11-2. ROM Read Cycle

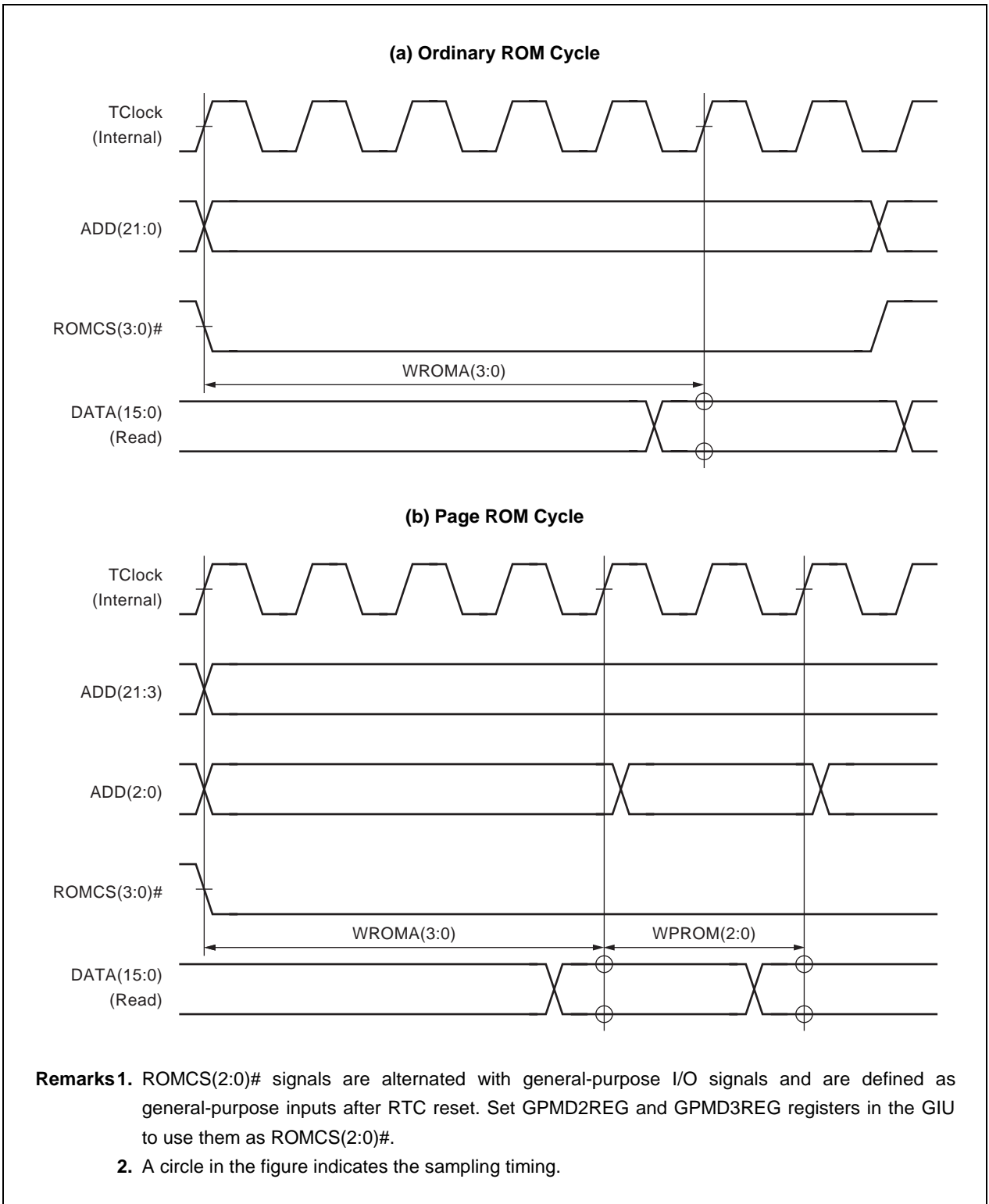

11.2.4 BCURFCNTREG (0x0A00 0010)

Bit	15	14	13	12	11	10	9	8
Name	Reserved	Reserved	BRF13	BRF12	BRF11	BRF10	BRF9	BRF8
R/W	R	R	R/W	R/W	R/W	R/W	R/W	R/W
At reset	0	0	0	1	1	1	1	1

Bit	7	6	5	4	3	2	1	0
Name	BRF7	BRF6	BRF5	BRF4	BRF3	BRF2	BRF1	BRF0
R/W	R/W	R/W	R/W	R/W	R/W	R/W	R/W	R/W
At reset	1	1	1	1	1	1	1	1

Bit	Name	Function
15, 14	Reserved	0 is returned when read
13 to 0	BRF(13:0)	<p>These bits select the DRAM refresh rate that is based on the TClock. The refresh rate is obtained by following expression.</p> <p>Refresh rate = BRF(13:0) x TClock Period</p> <p>For example, to select a 15.6 μs refresh rate with a 50-MHz TClock:</p> <p>BRF(13:0) = 15600 (ns) / 20 (ns) = 0x30C</p>

- Remarks 1.** When the IORDY signal does not become high level during the external ISA memory or I/O cycles over the DRAM refresh rate, a DRAM refresh cycle may be lost.
- 2.** Refresh timing is generated from detecting match between values of the internal up counter and BCURFCNTREG register. Therefore, when the BCURFCNTREG register value is changed smaller than current value, and if the internal counter value is bigger than the new BCURFCNTREG register value, the next CBR refresh timing is at next match after the counter rounds over.

11.2.5 REVIDREG (0x0A00 0014)

Bit	15	14	13	12	11	10	9	8
Name	RID3	RID2	RID1	RID0	MJREV3	MJREV2	MJREV1	MJREV0
R/W	R	R	R	R	R	R	R	R

Bit	7	6	5	4	3	2	1	0
Name	Reserved	Reserved	Reserved	Reserved	MNREV3	MNREV2	MNREV1	MNREV0
R/W	R	R	R	R	R	R	R	R

Bit	Name	Function
15 to 12	RID(3:0)	Processor revision ID (Read Only)
11 to 8	MJREV(3:0)	Major revision ID number (Read only)
7 to 4	Reserved	0 is returned when read
3 to 0	MNREV(3:0)	Minor revision ID (Read only)

This register is used to indicate revision of the V_R4181. The relationship between the values and revision of the V_R4181 is as follows.

V _R 4181 Revision	RID(3:0)	MJREV(3:0)	MINREV(3:0)
1.0	0x0	0x0	0x0
1.1	0x0	0x0	0x1
1.2	0x0	0x0	0x2
1.3	0x0	0x0	0x2

Even if the CPU core or the peripheral unit has been changed, there is no guarantee that REVIDREG register will be reflected, or that the changes to the revision number necessarily reflect real changes of the CPU core or the peripheral unit. For this reason, software should not rely on the revision number in REVIDREG register to characterize the units.

Caution Values differ depending on the delivery date.

11.2.6 CLKSPEEDREG (0x0A00 0018)

Bit	15	14	13	12	11	10	9	8
Name	Div2	Div3	Div4	Reserved	Reserved	Reserved	Reserved	Reserved
R/W	R	R	R	R	R	R	R	R

Bit	7	6	5	4	3	2	1	0
Name	Reserved	Reserved	Reserved	CLKSP4	CLKSP3	CLKSP2	CLKSP1	CLKSP0
R/W	R	R	R	R	R	R	R	R

Bit	Name	Function
15 to 13	DIV(2:4)	Value used to calculate the TClock / MBA clock / SDCLK operating frequency
12 to 5	Reserved	0 is returned when read
4 to 0	CLKSP(4:0)	Value used to calculate the CPU core operating clock (PClock) frequency

The following expression is used to calculate the PClock and TClock:

(1) Peripheral clock (TClock)

DIV(2:4)	Ratio	Mode
111	TClock = PClock / 1	Div1 mode
011	TClock = PClock / 2	Div2 mode
101	TClock = PClock / 3	Div3 mode
110	TClock = PClock / 4	Div4 mode
Others	Reserved	–

(2) CPU core clock (PClock)

$$PClock = (18.432 \text{ MHz} / CLKSP(4:0)) \times 64$$

Remark PClock frequency is decided by CLKSEL(2:0) pins status during RTC reset.
 TClock frequency is always a half of PClock frequency (Div2 mode) immediately after RTC reset. Software can change TClock Div-mode by PMUDIVREG register (0x0B0000AC).

11.3 ROM Interface

The VR4181 supports three ROM modes (ordinary ROM, PageROM and flash memory). The mode setting is set via BCUCNTRREG register's Rtype(1:0) bits and ROMWEN0 bit. Access speed setting in ordinary ROM or PageROM mode is set via BCUSPEEDREG register.

Remark The VR4181 supports only word (16-bit) access for external ROM devices.

11.3.1 External ROM devices memory mapping

Physical address	32-Mbit ROM	64-Mbit ROM
0x1FFF FFFF to 0x1FC0 0000	Bank 3 (ROMCS3#)	Bank 3 (ROMCS3#)
0x1FBF FFFF to 0x1F80 0000	Bank 2 (ROMCS2#)	
0x1F7F FFFF to 0x1F40 0000	Bank 1 (ROMCS1#)	Bank 2 (ROMCS2#)
0x1F3F FFFF to 0x1F00 0000	Bank 0 (ROMCS0#)	
0x1EFF FFFF to 0x1E80 0000	Reserved	Bank 1 (ROMCS1#)
0x1E7F FFFF to 0x1E00 0000	Reserved	Bank 0 (ROMCS0#)

Bank 3 contains boot vector and has a dedicated pin for chip select (ROMCS3#). Chip selects for Bank 2, 1, and 0, ROMCS(2:0)#, are alternated with general-purpose I/O signals and are defined as general-purpose inputs after RTC reset. Set GPMD2REG and GPMD3REG registers in the GIU to use them as ROMCS(2:0)#.

11.3.2 Connection to external ROM (x 16) devices

The ADD0 pin is logically connected to the address line ADD0 inside the VR4181 during DRAM accesses. However, during ROM or flash memory accesses, it is logically connected to the address line ADD1 inside the VR4181. This allows providing a greater address space capacity for ROM or flash memory. However, note that the ADD0 pin of a ROM or a flash memory must be connected to the ADD0 pin of the VR4181 when designing.

ROM address pin	32-Mbit ROM (2 Mbits x 16)		64-Mbit ROM (4 Mbits x 16)	
	VR4181 pin	CPU core physical address line	VR4181 pin	CPU core physical address
A21			ADD21	adr22
A20	ADD20	adr21	ADD20	adr21
A19	ADD19	adr20	ADD19	adr20
A18	ADD18	adr19	ADD18	adr19
A17	ADD17	adr18	ADD17	adr18
A16	ADD16	adr17	ADD16	adr17
A15	ADD15	adr16	ADD15	adr16
A14	ADD14	adr15	ADD14	adr15
A13	ADD13	adr14	ADD13	adr14
A12	ADD12	adr13	ADD12	adr13
A11	ADD11	adr12	ADD11	adr12
A10	ADD10	adr11	ADD10	adr11
A9	ADD9	adr10	ADD9	adr10
A8	ADD8	adr9	ADD8	adr9
A7	ADD7	adr8	ADD7	adr8
A6	ADD6	adr7	ADD6	adr7
A5	ADD5	adr6	ADD5	adr6
A4	ADD4	adr5	ADD4	adr5
A3	ADD3	adr4	ADD3	adr4
A2	ADD2	adr3	ADD2	adr3
A1	ADD1	adr2	ADD1	adr2
A0	ADD0	adr1	ADD0	adr1

11.3.3 Example of ROM connection

(1) 32-Mbit ordinary ROM

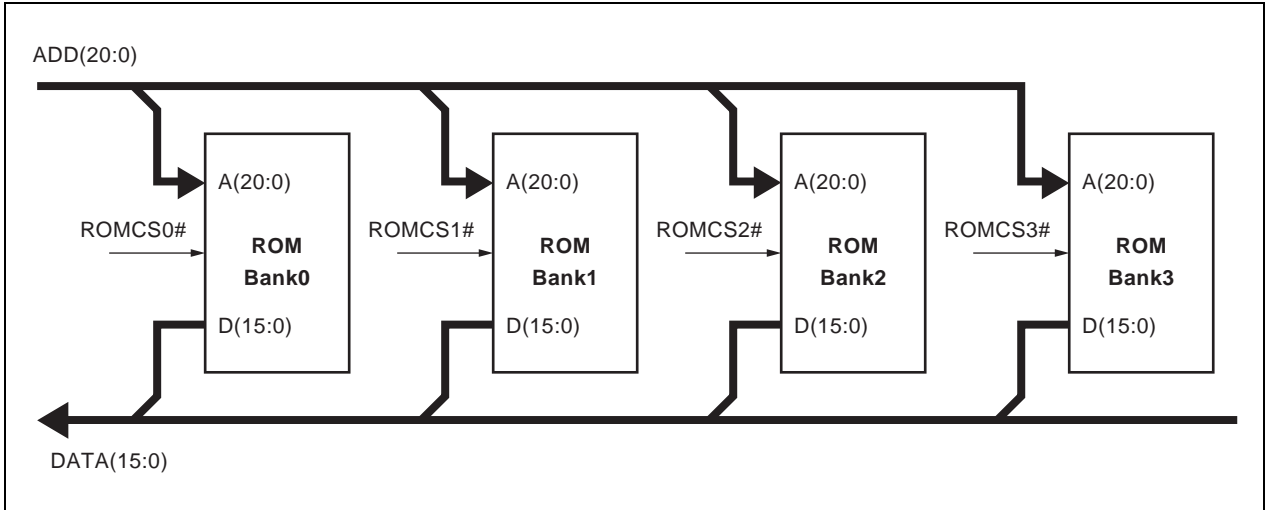

(2) 64-Mbit ordinary ROM

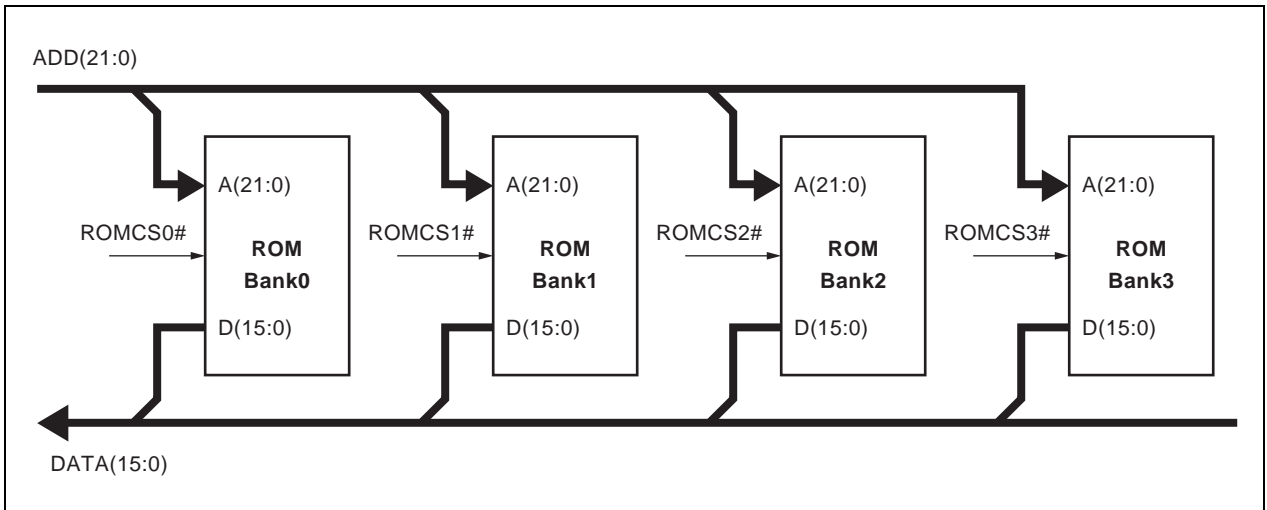

(3) 32-Mbit PageROM

Remark The external PageROM is accessed in 8 words (1 word = 16 bits) for each cache line.

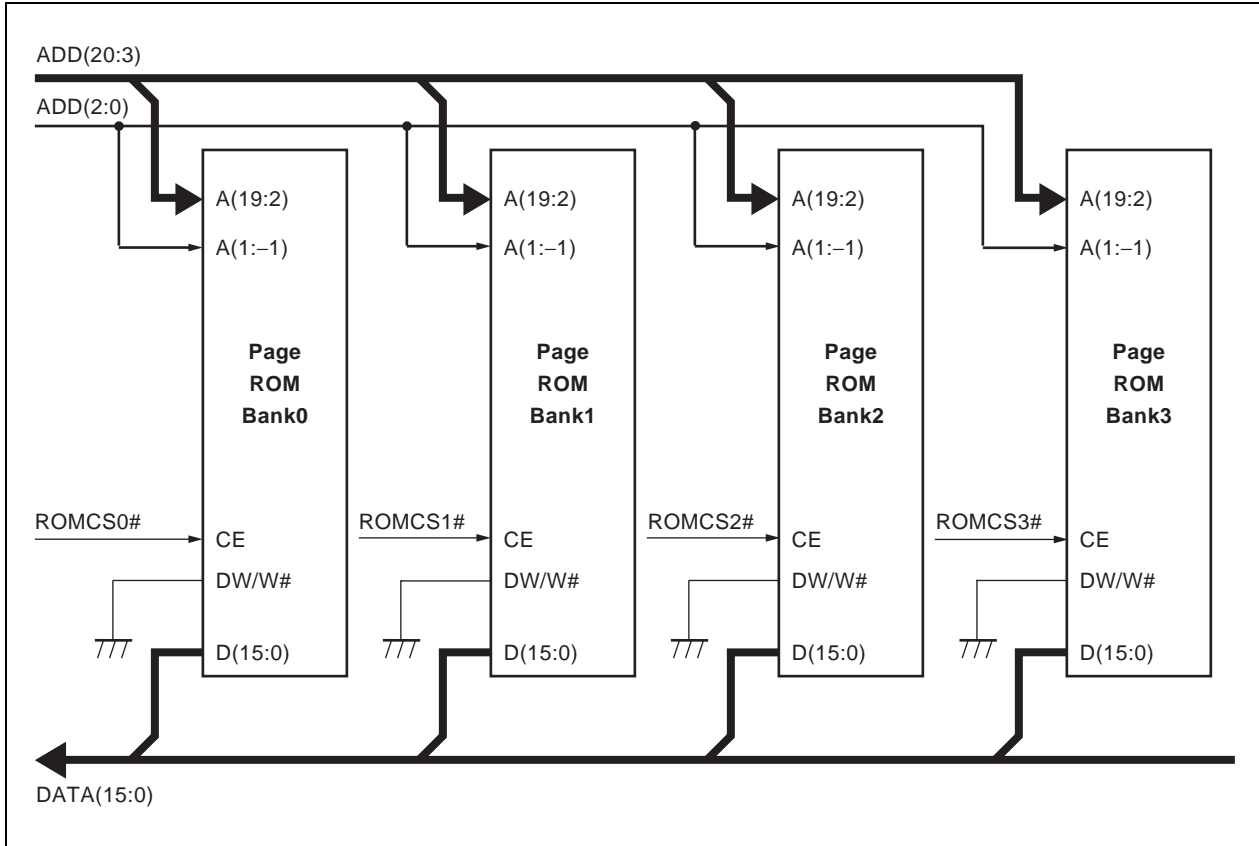

(4) 64-Mbit PageROM

Remark The external PageROM is accessed in 8 words (1 word = 16 bits) for each cache line.

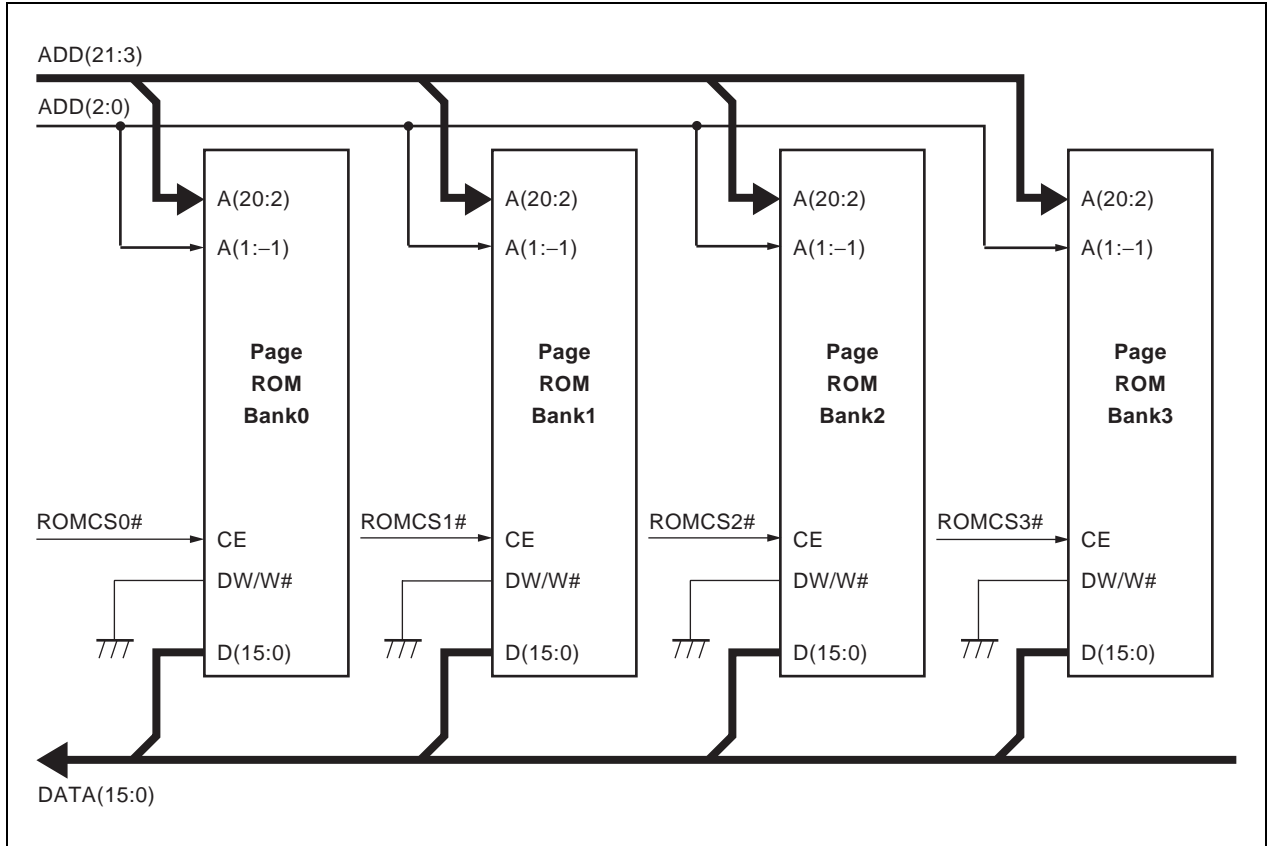

(5) 32-Mbit flash memory (Intel DD28F032)

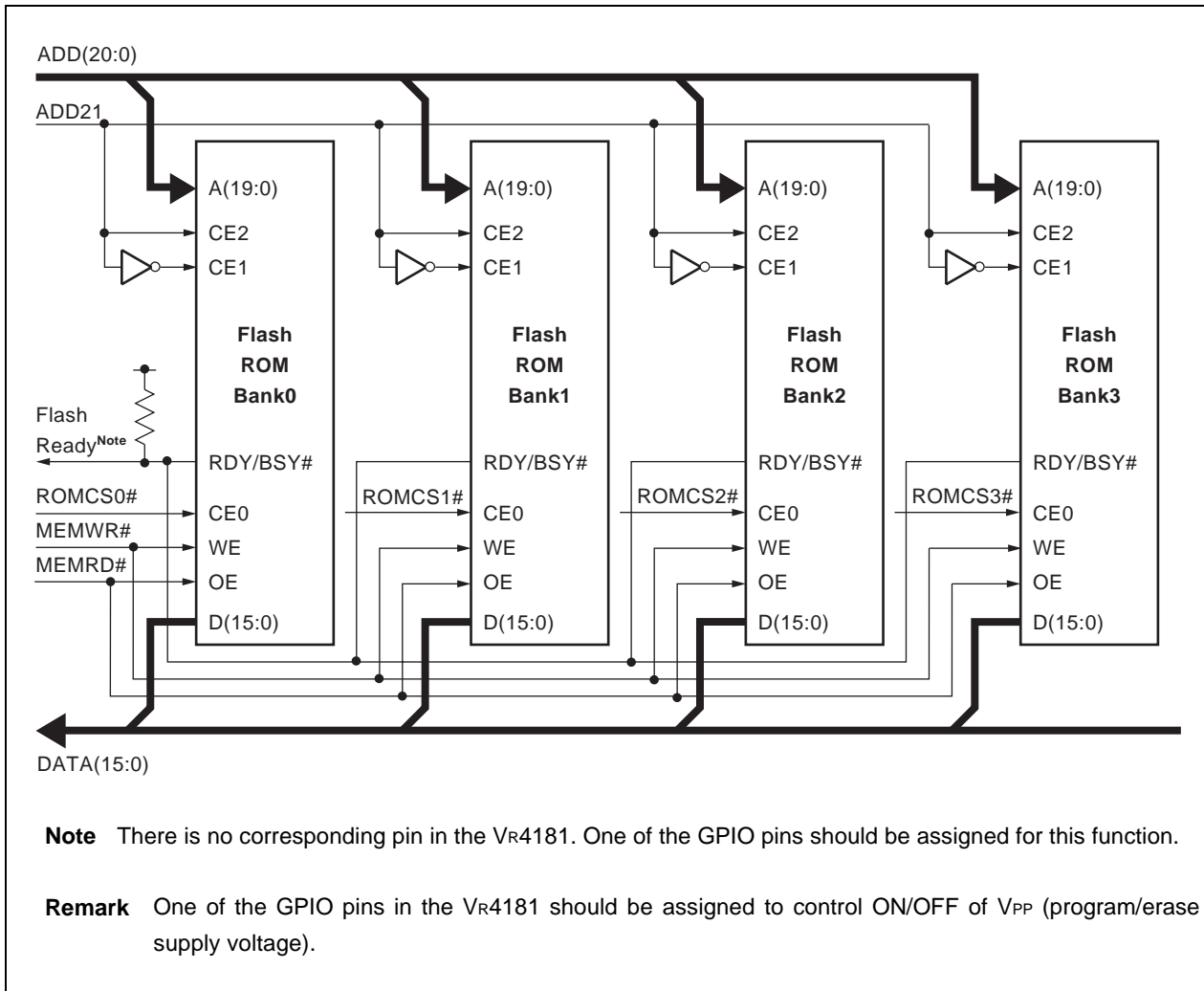

(6) 64-Mbit flash memory (Intel StrataFlash™ 64 Mbit)

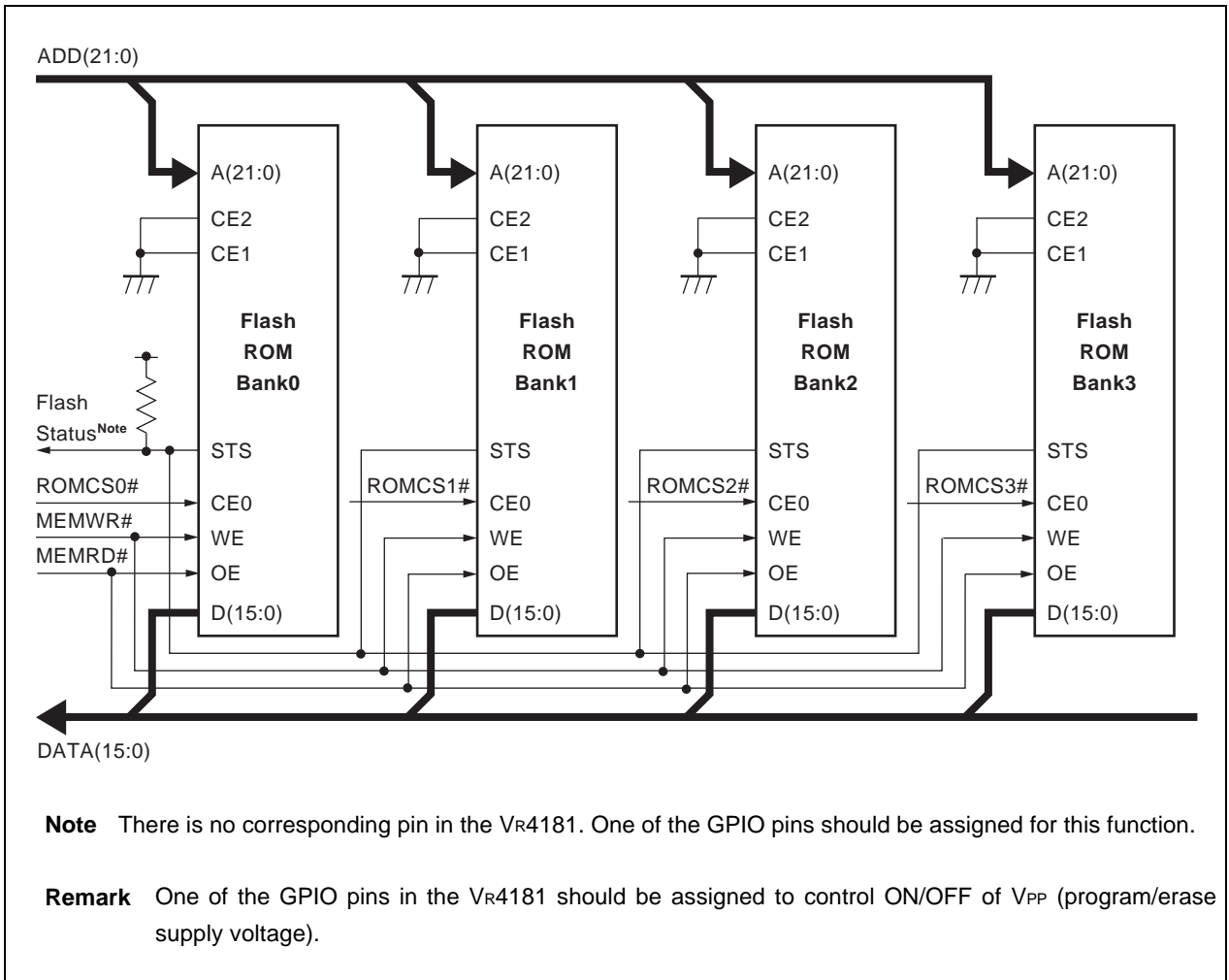

11.3.4 External ROM cycles

The following timing diagrams defines the external ROM cycles depending on the settings in the bus control register and bus speed control register.

(1) Ordinary ROM read cycle

Figure 11-3. Ordinary ROM Read Cycle (WROMA(3:0) = 0100)

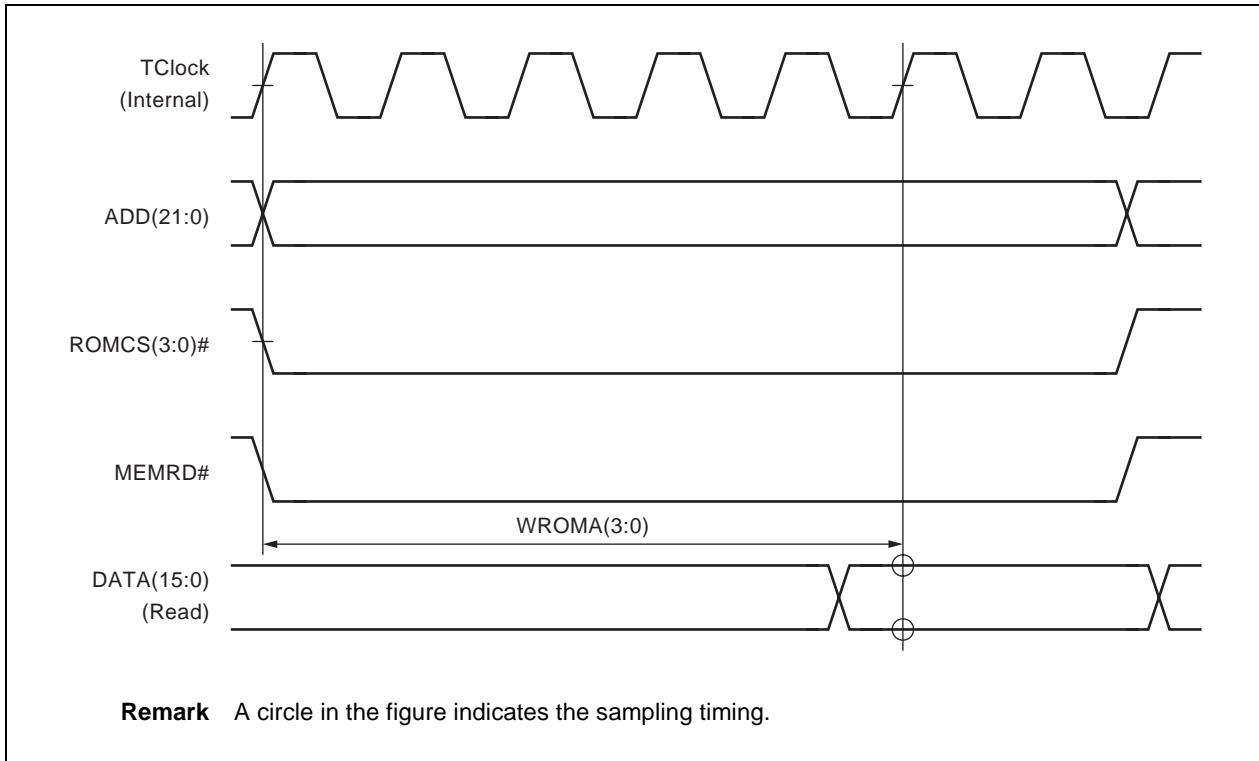

(2) PageROM cycle

Figure 11-4. PageROM Read Cycle (WROMA(3:0) = 0011, WPROM(2:0) = 001)

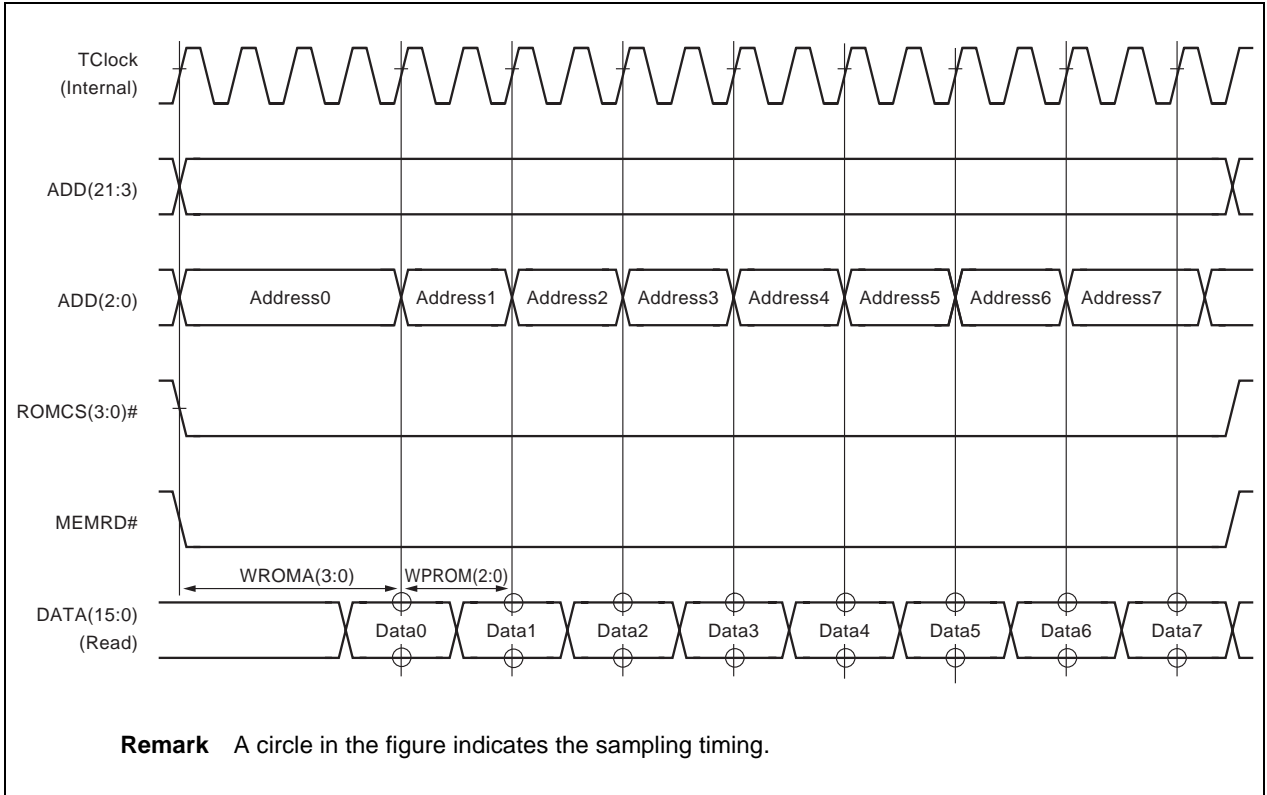

(3) Flash memory read cycle

Figure 11-5. Flash Memory Read Cycle (WROMA(3:0) = 0111)

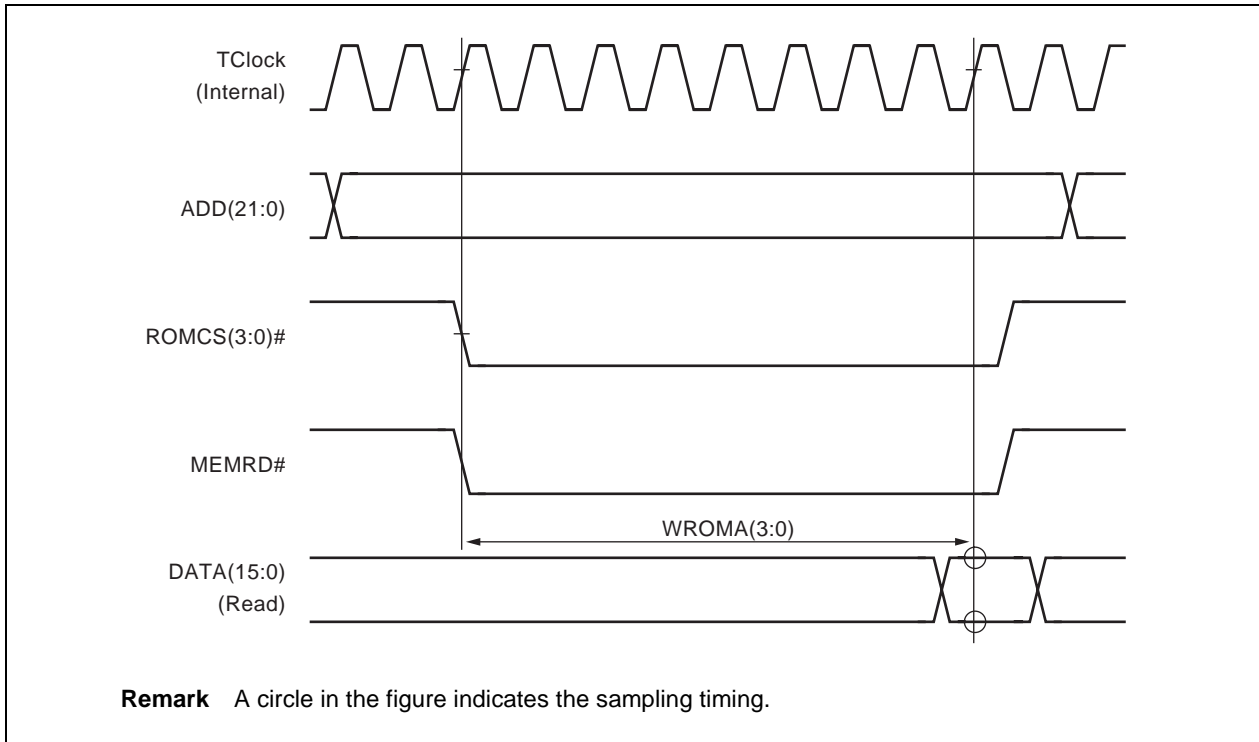

(4) Flash memory write cycle

Figure 11-6. Flash Memory Write Cycle (WROMA(3:0) = 0111)

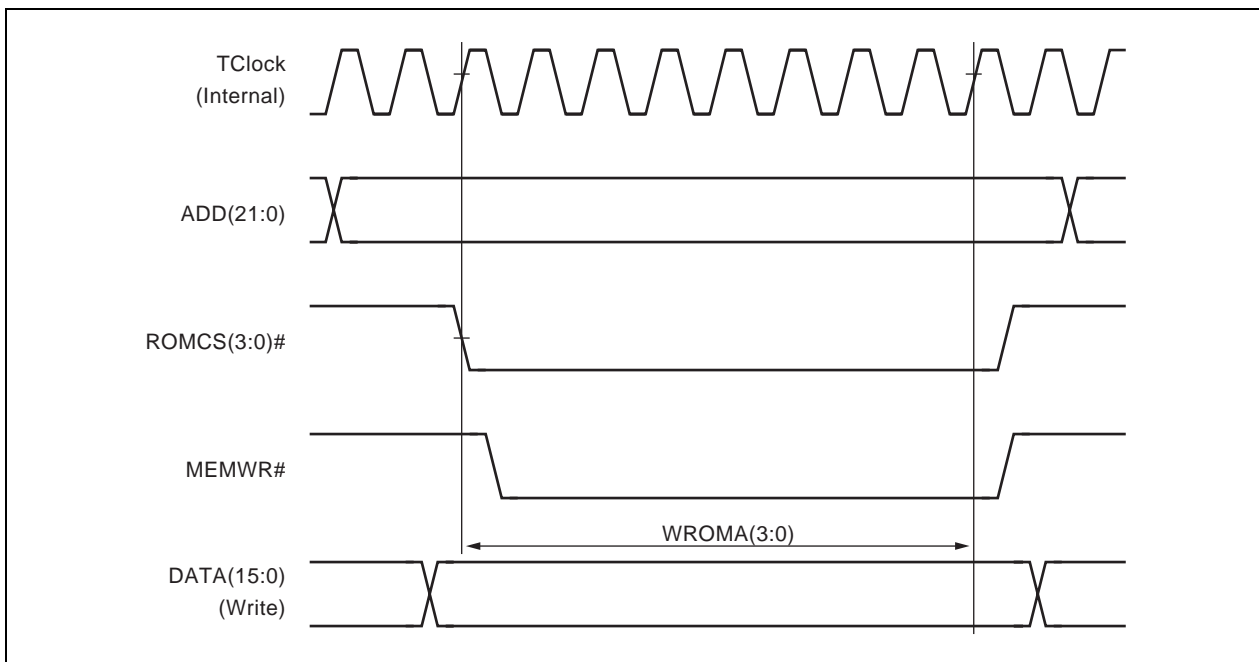

11.4 DRAM Interface

The Vr4181 supports 16-Mbit or 64-Mbit DRAM (EDO DRAM or SDRAM). The DRAM size, type and access speed setting is set via the Memory Controller's registers.

11.4.1 EDO DRAM configuration

Figure 11-7. External EDO DRAM Configuration

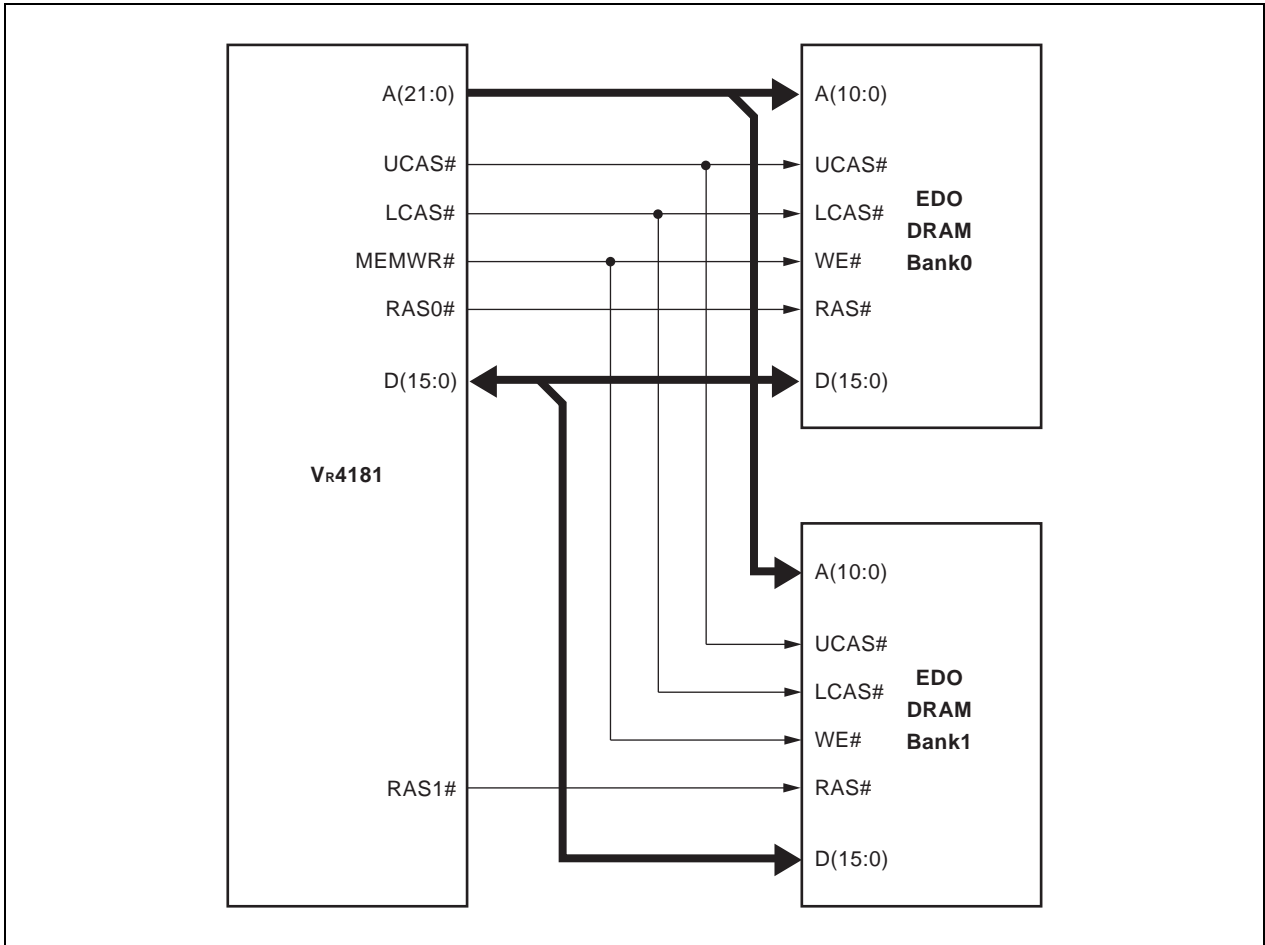

For 2 Mbytes of DRAM bank 0 is installed with 1-Mbit x 16 device.

The 64-Mbit DRAM (EDO) configuration is the same as that of the 16-Mbit with the exception of one extra address line A12 and the address space decoding:

Bank 0 with 64-Mbit DRAM is equal to 16 Mbytes in size.

DRAM bank	Physical address (16 Mbits)	Physical address (64 Mbits)
Bank 0	0x001F FFFF to 0x0000 0000	0x007F FFFF to 0x0000 0000
Bank 1	0x003F FFFF to 0x0020 0000	0x00FF FFFF to 0x0080 0000

Remark Only 64-Mbit EDO DRAMs with 13 rows and 9 columns are supported.

11.4.2 Mix memory mode (EDO DRAM only)

The memory configuration register provides two bits each for Bank 0 and Bank 1 to set types of DRAMs to be used. This allows the two banks to be configured with different types of DRAMs, for example, Bank 0 can be mapped on 64-Mbit devices and Bank 1 on 16-Mbit devices, to optimize the cost of the total memory required.

Table 11-2. Vr4181 EDO DRAM Capacity

Bank 0	Bank 1	Total DRAM capacity
16 Mbits	0	2 MB
16 Mbits	16 Mbits	4 MB
64 Mbits	0	8 MB
64 Mbits	16 Mbits	10 MB
64 Mbits	64 Mbits	16 MB

11.4.3 EDO DRAM timing parameters

The following table shows an example of EDO DRAM timing parameters when using -60 devices. These parameters are set in EDOMCTYREG register.

TClock frequency	RAS to CAS delay	CAS pulse width	CAS precharge	RAS precharge	RAS pulse width	Self refresh RAS precharge
66 MHz	3 TClock	1 TClock	1 TClock	3 TClock	3 TClock	8 TClock
50 MHz	2 TClock	1 TClock	1 TClock	2 TClock	3 TClock	6 TClock
33 MHz	2 TClock	1/2 TClock	1/2 TClock	2 TClock	2 TClock	4 TClock
25 MHz	2 TClock	1/2 TClock	1/2 TClock	1 TClock	2 TClock	3 TClock

11.4.4 SDRAM configuration

Figure 11-8. SDRAM Configuration

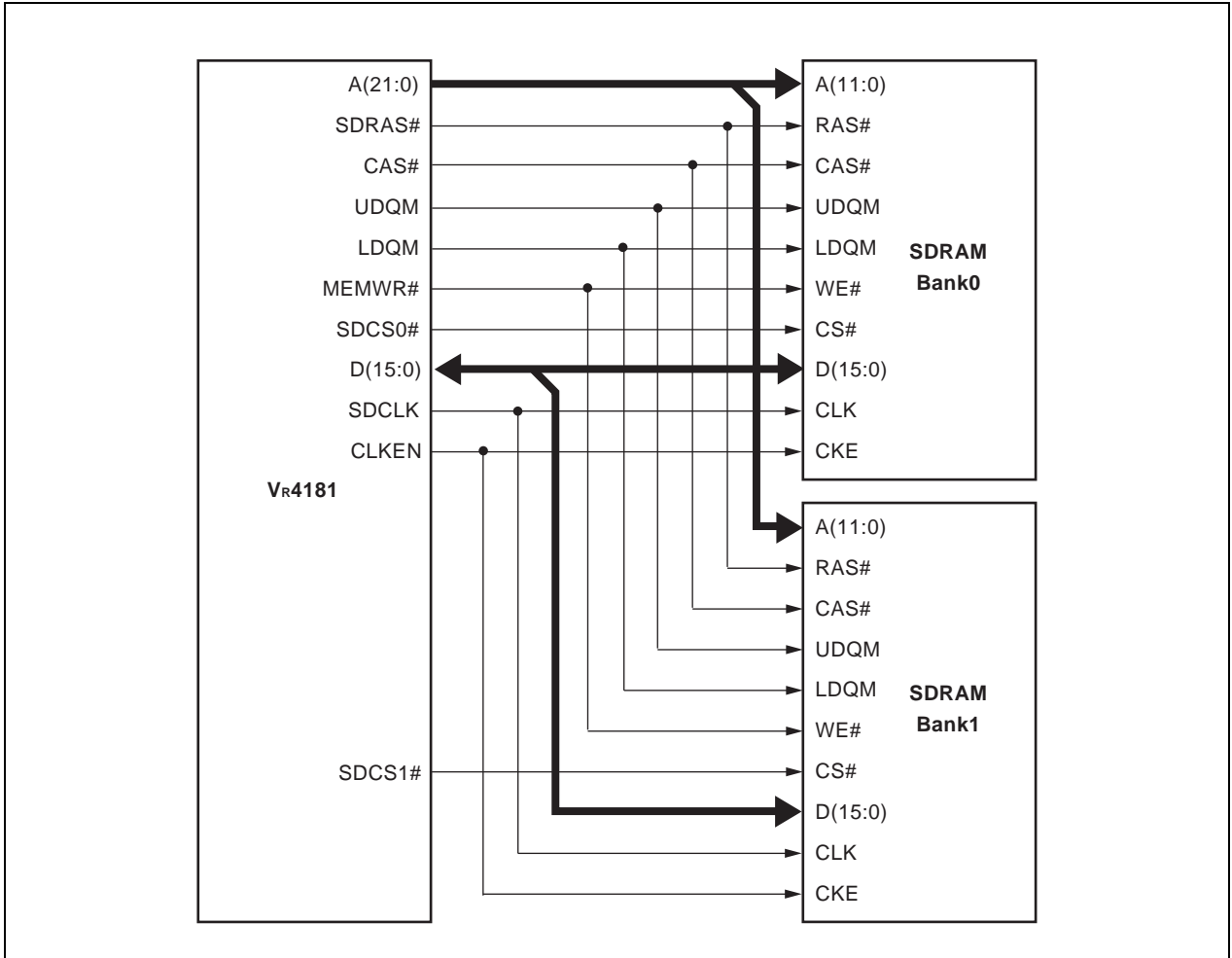

Remark The supported SDRAM densities and internal bank configuration are as follows.

Capacity	Configuration	Address pins	Bank select pin
16 Mbits	512 Kbits x 16 x 2 banks	A(10:0)	A11
64 Mbits	2 Mbits x 16 x 2 banks	A(12:0)	A13
64 Mbits	1 Mbits x 16 x 4 banks	A(11:0)	A(13:12)

11.5 Memory Controller Register Set

Table 11-3. Memory Controller Registers

Physical address	R/W	Register symbol	Function
0x0A00 0300	R/W	EDOMCYTREG	Memory cycle timing register
0x0A00 0304	R/W	MEMCFG_REG	Memory configuration register
0x0A00 0308	R/W	MODE_REG	SDRAM mode register
0x0A00 030C	R/W	SDTIMINGREG	SDRAM timing register

Caution Since these registers are powered by 2.5 V power supply, the contents of these registers are cleared after Hibernate mode

11.5.1 EDOMCYTREG (0x0A00 0300)

(1/2)

Bit	15	14	13	12	11	10	9	8
Name	Reserved	Reserved	Reserved	SrefRpre2	SrefRpre1	SrefRpre0	Caspre1	Caspre0
R/W	R	R	R	R/W	R/W	R/W	R/W	R/W
At reset	0	0	0	0	0	0	0	0

Bit	7	6	5	4	3	2	1	0
Name	Rcasdly1	Rcasdly0	Tcas1	Tcas0	Trp1	Trp0	Tras1	Tras0
R/W	R/W	R/W	R/W	R/W	R/W	R/W	R/W	R/W
At reset	0	0	0	0	0	0	0	0

Bit	Name	Function
15 to 13	Reserved	0 is returned when read
12 to 10	SRRASpre(2:0)	Self refresh RAS precharge time 000 : 3 TClock 001 : 4 TClock 010 : 6 TClock 011 : 8 TClock 100 : 11 TClock Others : Reserved
9, 8	CASpre(1:0)	CAS precharge time 00 : 1/2 TClock 01 : 1 TClock 10 : 2 TClock 11 : Reserved
7, 6	Rcasdly(1:0)	RAS to CAS delay time 00 : 2 TClock 01 : 3 TClock 10 : 5 TClock 11 : 6 TClock

(2/2)

Bit	Name	Function
5, 4	Tcas(1:0)	CAS pulse width 00 : 1/2 TClock 01 : 1 TClock 10 : 2 TClock 11 : Reserved
3, 2	Trp(1:0)	RAS precharge time 00 : 1 TClock 01 : 2 TClock 10 : 3 TClock 11 : 4 TClock
1, 0	Tras(1:0)	RAS pulse width 00 : 2 TClock 01 : 3 TClock 10 : 5 TClock 11 : 6 TClock

This register is used to set EDO DRAM timing parameters. Software must set these parameters suitable before using DRAM.

Remark Setting Tcas = 1/2 TClock and CASpre = 1 TClock, or setting Tcas = 1 TClock and CASpre = 1/2 TClock at the same time, is not supported.

11.5.2 MEMCFG_REG (0x0A00 0304)

(1/2)

Bit	15	14	13	12	11	10	9	8
Name	Init	Reserved	Reserved	Reserved	B1Config1	B1Config0	Reserved	Bstreftype
R/W	R/W	R	R	R	R/W	R/W	R	R/W
At reset	0	0	0	0	0	0	0	0

Bit	7	6	5	4	3	2	1	0
Name	BstRefr	EDOAsym	Reserved	Reserved	Reserved	B0Config1	B0Config0	EDO/SDRAM
R/W	R/W	R/W	R	R	R	R/W	R/W	R/W
At reset	0	0	0	0	0	0	0	0

Bit	Name	Function
15	Init	This bit is for SDRAM only. When software writes 1 to this bit, the memory controller will execute a SDRAM mode set command. After the SDRAM mode is set, hardware will automatically reset this bit to 0. When EDO DRAM is used, this bit must be set to 1.
14 to 12	Reserved	0 is returned when read
11, 10	B1Config(1:0)	Bank 1 capacity 00 : Bank 1 is not installed 01 : 16 Mbits 10 : 64 Mbits 11 : Reserved
9	Reserved	0 is returned when read
8	Bstreftype	Burst refresh type. This bit determines the number of CBR burst refresh cycles executed before entering and exiting self-refresh mode. 0 : 8 rows refreshed 1 : All rows refreshed
7	BstRefr	Burst refresh enable. This bit enables or disables burst CBR refresh cycles when entering or exiting self-refresh mode 0 : Disable CBR burst refresh 1 : Enable CBR burst refresh Burst and distributive CBR refresh are mixed if this bit is set to 1. For some kind of DRAMs, mix use of burst and distributive CBR refresh may not be allowed.
6	EDOAsym	EDO DRAM configuration 0 : Asymmetrical 16-Mbit EDO DRAM : 12 Rows by 8 Columns 64-Mbit EDO DRAM : 13 Rows by 9 Columns 1 : Symmetrical 16-Mbit EDO DRAM : 10 Rows by 10 Columns 64-Mbit EDO DRAM : Reserved

Bit	Name	Function
5 to 3	Reserved	0 is returned when read
2, 1	B0Config(1:0)	Bank 0 Capacity 00 : Bank 0 is not installed 01 : 16 Mbit 10 : 64 Mbit 11 : Reserved
0	EDO/SDRAM	DRAM Type 0 : EDO DRAM 1 : SDRAM

This register is used to set DRAM type (capacity, type, organization etc) of Bank0 and Bank1.

Remark During the 64-Mbit SDRAM-mode register write, A13 of the address bus had forced logic 1 though it should be logic 0. But during the 16-Mbit SDRAM-mode register write, A13 had forced to logic 0. In order to initialize 64-Mbit SDRAM correctly, software has to do the following sequence.

- <1> Set B0Config and B1Config bits of MEMCFG_REG register to 01
- <2> Set MODE_REG register to proper value
- <3> Initialize SDRAM by setting Init bit of MEMCFG_REG register
- <4> Set B0Config and B1Config bits of MEMCFG_REG register to 10

11.5.3 MODE_REG (0x0A00 0308)

Bit	15	14	13	12	11	10	9	8
Name	Reserved	Reserved	Reserved	Reserved	0	0	BR-SW	TE-Ven1
R/W	R	R	R	R	R/W	R/W	R/W	R/W
At reset	0	0	0	0	0	0	0	0

Bit	7	6	5	4	3	2	1	0
Name	TE-Ven2	LTMMode2	LTMMode1	LTMMode0	WT	BL2	BL1	BL0
R/W	R/W	R/W	R/W	R/W	R	R/W	R/W	R/W
At reset	0	0	0	0	0	0	0	0

Bit	Name	Function
15 to 12	Reserved	0 is returned when read
11, 10	0	These bits should be always written to 00.
9	BR-SW	Burst read - single write This bit should be always written to 0.
8, 7	TE-Ven(1:0)	These two bits define a JEDEC test cycle and vendor specific cycles. These bits should be always written to 00.
6-4	LTMMode(2:0)	CAS latency mode ^{Note} 000 : Reserved 001 : 1 clock 010 : 2 clocks 011 : 3 clocks Others : Reserved
3	WT	Wrap type for the burst cycles. This bit should be always written to 0. 0 : Sequential (default)
2-0	BL(2:0)	Burst length. These bits should be always written to 111. 111 : Full page (Normal when WT = 0 , reserved when WT = 1)

Note The CAS latency bits need to be set according to the operation speed of the SDCLK (SDRAM clock).

This is the pass-through register for the Vr4181 to set the SDRAM chip internal mode register. This register should be written before the Init bit of MEMCFG_REG register is set to 1.

11.5.4 SDTIMINGREG (0x0A00 030C)

Bit	15	14	13	12	11	10	9	8
Name	Reserved	Reserved	Reserved	Reserved	Reserved	Reserved	Reserved	Reserved
R/W	R	R	R	R	R	R	R/W	R/W
At reset	0	0	0	0	0	0	0	0

Bit	7	6	5	4	3	2	1	0
Name	TRAS1	TRAS0	TRC1	TRC0	TRP1	TRP0	TRCD1	TRCD0
R/W	R/W	R/W	R/W	R/W	R/W	R/W	R/W	R/W
At reset	0	0	0	0	0	0	0	0

Bit	Name	Function
15 to 10	Reserved	0 is returned when read
9	Reserved	Write 0 when write. ^{Note}
8	Reserved	Write 1 when write. ^{Note}
7, 6	TRAS(1:0)	TRAS in clock cycles 00 : 3 SDCLK (for 25 MHz SDCLK) 01 : 5 SDCLK (for 66, 50 or 33 MHz SDCLK) Others : Prohibited
5, 4	TRC(1:0)	TRC in clock cycles 00 : 4 SDCLK (for 25 MHz SDCLK) 01 : 7 SDCLK (for 66, 50 or 33 MHz SDCLK) Others : Prohibited
3, 2	TRP(1:0)	TRP in clock cycles 00 : 1 SDCLK (for 25 MHz SDCLK) 01 : Prohibited 10 : 3 SDCLK (for 66, 50 or 33 MHz SDCLK) 11 : Prohibited
1, 0	TRCD(1:0)	TRCD In clock cycles 00 : 1 SDCLK (for 25 MHz SDCLK) 01 : 2 SDCLK (for 66, 50 or 33 MHz SDCLK) Others : Prohibited

Note Bits 9, 8 must be set to 01 before using SDRAM. Especially, default value of bit 8 must be 0 before 1 is set. When these bits are not 01, the V_{R4181} may not work correctly.

This register is used to set SDRAM timing parameters. Software must set this register suitable before using DRAM.

11.6 ISA Bridge

The Vr4181 has a defined external bus used for ROM, Flash, DRAM and I/O. This bus's operation emulates an ISA bus. The Vr4181 also uses an ISA-like bus internally for the slow, embedded peripherals.

11.7 ISA Bridge Register Set

The following registers provide configuration and control of the ISA Bridge.

Table 11-4. ISA Bridge Registers

Physical address	R/W	Register symbol	Function
0x0B00 02C0	R/W	ISABRGCTL	ISA Bridge control register
0x0B00 02C2	R/W	ISABRGSTS	ISA Bridge status register
0x0B00 02C4	R/W	XISACTL	External ISA control register

11.7.1 ISABRGCTL (0x0B00 02C0)

Bit	15	14	13	12	11	10	9	8
Name	Reserved	Reserved	Reserved	Reserved	Reserved	Reserved	Reserved	Reserved
R/W	R	R	R	R	R	R	R	R
RTCRST	0	0	0	0	0	0	0	0
Other resets	0	0	0	0	0	0	0	0

Bit	7	6	5	4	3	2	1	0
Name	Reserved	Reserved	Reserved	Reserved	Reserved	Reserved	PCLKDIV1	PCLKDIV0
R/W	R	R	R	R	R	R	R/W	R/W
RTCRST	0	0	0	0	0	0	0	0
Other resets	0	0	0	0	0	0	0	0

Bit	Name	Function
15 to 2	Reserved	0 is returned when read
0	PCLKDIV(1:0)	PCLK (peripheral clock) divisor selection. These bits select the operating frequency of PCLK. 00 : TClock / 8 01 : TClock / 4 10 : TClock / 2 11 : TClock / 1

This register is used to set the PCLK divisor rate. PCLK is for internal ISA peripherals, and its frequency must be set to less than 33 MHz.

11.7.2 ISABRGSTS (0x0B00 02C2)

Bit	15	14	13	12	11	10	9	8
Name	Reserved	Reserved	Reserved	Reserved	Reserved	Reserved	Reserved	Reserved
R/W	R	R	R	R	R	R	R	R
RTCRST	0	0	0	0	0	0	0	0
Other resets	0	0	0	0	0	0	0	0

Bit	7	6	5	4	3	2	1	0
Name	Reserved	Reserved	Reserved	Reserved	Reserved	Reserved	Reserved	IDLE
R/W	R	R	R	R	R	R	R	R
RTCRST	0	0	0	0	0	0	0	0
Other resets	0	0	0	0	0	0	0	0

Bit	Name	Function
15 to 1	Reserved	0 is returned when read
0	IDLE	ISA Bridge status 0 : ISA Bridge is busy 1 : ISA Bridge is idle

This register shows the ISA Bridge operation status.

11.7.3 XISACTL (0x0B00 02C4)

(1/2)

Bit	15	14	13	12	11	10	9	8
Name	Reserved	Reserved	Reserved	Reserved	Reserved	EXTRESULT	INTRESULT	EXBUFFEN
R/W	R	R	R	R	R	R/W	R/W	R/W
RTCRST	0	0	0	0	0	1	0	1
Other resets	0	0	0	0	0	1	0	1

Bit	7	6	5	4	3	2	1	0
Name	MEMWS1	MEMWS0	IOWS1	IOWS0	Reserved	Reserved	SCLKDIV1	SCLKDIV0
R/W	R/W	R/W	R/W	R/W	R	R	R/W	R/W
RTCRST	0	0	0	0	0	0	0	0
Other resets	0	0	0	0	0	0	0	0

Bit	Name	Function
15 to 11	Reserved	0 is returned when read
10	EXTRESULT	External ISA result cycle enable 0 : The MBA result cycle for the external ISA bus is disabled. The MBA bus arbiter waits till external ISA read is finished. 1 : The MBA result cycle for the external ISA bus is enabled. The MBA bus arbiter will re-access ISA bus after finishing operation.
9	INTRESULT	Internal ISA result cycle enable 0 : The MBA result cycle for the internal ISA bus is disabled. The MBA bus arbiter waits till internal ISA read is finished. 1 : The MBA result cycle for the internal ISA bus is enabled. The MBA bus arbiter will re-access ISA bus after finishing operation.
8	EXBUFFEN	External buffer enable 0 : Enable external buffer control on SYSDIR and SYSEN# pins 1 : Disable external buffer control on SYSDIR and SYSEN# pins (SYSEN# and SYSDIR pins are both force to low level)
7, 6	MEMWS(1:0)	External ISA memory wait states 00 : Memory read/write strobe 1.5 SYSCLK cycles wide 01 : Memory read/write strobe 2.5 SYSCLK cycles wide 10 : Memory read/write strobe 3.5 SYSCLK cycles wide 11 : Memory read/write strobe 4.5 SYSCLK cycles wide
5, 4	IOWS(1:0)	External ISA I/O wait states 00 : I/O read/write strobe 1.5 SYSCLK cycles wide 01 : I/O read/write strobe 2.5 SYSCLK cycles wide 10 : I/O read/write strobe 3.5 SYSCLK cycles wide 11 : I/O read/write strobe 4.5 SYSCLK cycles wide

(2/2)

Bit	Name	Function
3, 2	Reserved	0 is returned when read
1, 0	SCLKDIV(1:0)	SYSCLK divisor selection 00 : PCLK / 2 01 : PCLK / 3 10 : PCLK / 6 11 : PCLK / 8

This register is used to set the external ISA configurations.

[MEMO]

CHAPTER 12 DMA CONTROL UNIT (DCU)

12.1 General

The DMA Control Unit (DCU) controls four channels of DMA transfer. Two of them are allocated for the AIU (microphone and speaker), though the remaining two are reserved for future use.

The Microphone channel performs the I/O-to-memory transfers from the ADC included in the AIU to memory. The Speaker channel performs the memory-to-I/O transfers from memory to the DAC included in the AIU.

Each DMA channel supports both a primary and a secondary memory buffer. The Source1/Source2 or Destination1/Destination2 Address registers for the associated channel determine the starting address of each memory buffer. The sizes of memory buffers are determined in the associated Record Length registers.

The DCU uses the primary and secondary DMA buffers alternately when transferring. For example, during the first DMA transfer following either hardware or software reset of the DCU, DMA transfers will start using the primary DMA buffer. If the total number of DMA transfers through the primary DMA buffer reaches the value set in the associated record length register, the next DMA transfer will be performed using the secondary DMA buffer. Software must keep track of which buffer contains valid DMA data.

Software may configure any of the DMA channels to operate in one of two modes; auto stop or auto load. When a channel is configured to operate in auto stop mode, the DCU terminates DMA transfers after the number of transfers specified by the record length register and automatically resets the DMA mask bit for that channel. Once the mask bit is automatically reset, the DCU ignores all subsequent DMA requests for this channel. To resume DMA transfers in this mode, software must again unmask DMA transfers for this channel. Once software unmasks DMA requests, the DCU will resume DMA transfers utilizing the secondary memory buffer.

When configured for auto load mode, the DCU does not terminate DMA transfers after the number of DMA transfers specified by the record length register. Instead, the DCU will automatically switch to the secondary DMA buffer and continue servicing DMA requests.

In either mode, auto stop or auto load, the DCU always alternates memory transfers between the primary and secondary DMA buffers. Software must keep track of the total number of transfers and assure the appropriate DMA buffer is loaded with new DMA data before starting another DMA transfer.

The DCU may be programmed to generate an EOP interrupt request independent of auto stop or auto load mode. The EOP interrupt request is generated once the number of DMA transfers specified by the record length register has occurred.

Priority of each DMA channel is fixed. The channel priority is as follows.

1. AIU Microphone channel
2. AIU Speaker channel

DCU runs at the MBA bus clock (TClock) frequency.

Remark The DCU contains a 32-bit temporary storage register for each DMA channel. For memory-to-I/O transfers, the DCU performs a 32-bit memory read from DRAM and stores the read data into the temporary storage register. The DCU then transfers data from this register to the target I/O device. For a 16-bit device such as the Speaker channel, the DCU will perform 2 I/O writes to the DAC for each memory read.

During DMA transfers, all DCU registers are write-protected if valid data is present in the temporary storage registers. Because of this, when DMA transfers are running, software must read a DMA register after write to confirm that the register has been correctly set.

12.2 DCU Registers

Table 12-1. DCU Registers

Address	R/W	Register symbol	Function
0x0A00 0020	R/W	MICDEST1REG1	Microphone destination 1 address register 1
0x0A00 0022	R/W	MICDEST1REG2	Microphone destination 1 address register 2
0x0A00 0024	R/W	MICDEST2REG1	Microphone destination 2 address register 1
0x0A00 0026	R/W	MICDEST2REG2	Microphone destination 2 address register 2
0x0A00 0028	R/W	SPKRRC1REG1	Speaker source 1 address register 1
0x0A00 002A	R/W	SPKRRC1REG2	Speaker source 1 address register 2
0x0A00 002C	R/W	SPKRRC2REG1	Speaker source 2 address register 1
0x0A00 002E	R/W	SPKRRC2REG2	Speaker source 2 address register 2
0x0A00 0040	R/W	DMARSTREG	DMA reset register
0x0A00 0046	R/W	AIUDMAMSKREG	Audio DMA mask register
0x0A00 0600 to 0x0A00 0654	R/W	–	Reserved. Write 0 when write. 0 is returned after a read.
0x0A00 0658	R/W	MICRCLENREG	Microphone record length register
0x0A00 065A	R/W	SPKRCLNREG	Speaker record length register
0x0A00 065C	R/W	–	Reserved. Write 0 when write. 0 is returned after a read.
0x0A00 065E	R/W	MICDMACFGREG	Microphone DMA configuration register
0x0A00 0660	R/W	SPKDMACFGREG	Speaker DMA configuration register
0x0A00 0662	R/W	DMAITRQREG	DMA interrupt request register
0x0A00 0664	R/W	DMACLTREG	DMA control register
0x0A00 0666	R/W	DMAITMKREG	DMA interrupt mask register

12.2.1 Microphone destination 1 address registers

(1) MICDEST1REG1 (0x0A00 0020)

Bit	15	14	13	12	11	10	9	8
Name	MD1A15	MD1A14	MD1A13	MD1A12	MD1A11	MD1A10	MD1A9	MD1A8
R/W	R/W	R/W	R/W	R/W	R/W	R/W	R/W	R/W
At reset	0	0	0	0	0	0	0	0

Bit	7	6	5	4	3	2	1	0
Name	MD1A7	MD1A6	MD1A5	MD1A4	MD1A3	MD1A2	MD1A1	MD1A0
R/W	R/W	R/W	R/W	R/W	R/W	R/W	R/W	R/W
At reset	0	0	0	0	0	0	0	0

Bit	Name	Function
15 to 0	MD1A(15:0)	Lower 16 bits (A(15:0)) of DMA destination 1 address for Microphone

(2) MICDEST1REG2 (0x0A00 0022)

Bit	15	14	13	12	11	10	9	8
Name	MD1A31	MD1A30	MD1A29	MD1A28	MD1A27	MD1A26	MD1A25	MD1A24
R/W	R/W	R/W	R/W	R/W	R/W	R/W	R/W	R/W
At reset	0	0	0	0	0	0	0	0

Bit	7	6	5	4	3	2	1	0
Name	MD1A23	MD1A22	MD1A21	MD1A20	MD1A19	MD1A18	MD1A17	MD1A16
R/W	R/W	R/W	R/W	R/W	R/W	R/W	R/W	R/W
At reset	0	0	0	0	0	0	0	0

Bit	Name	Function
15 to 0	MD1A(31:16)	Upper 16 bits (A(31:16)) of DMA destination 1 address for Microphone

These two registers specify the destination memory address of the primary DMA buffer for the Microphone channel.

12.2.2 Microphone destination 2 address registers

(1) MICDEST2REG1 (0x0A00 0024)

Bit	15	14	13	12	11	10	9	8
Name	MD2A15	MD2A14	MD2A13	MD2A12	MD2A11	MD2A10	MD2A9	MD2A8
R/W	R/W	R/W	R/W	R/W	R/W	R/W	R/W	R/W
At reset	0	0	0	0	0	0	0	0

Bit	7	6	5	4	3	2	1	0
Name	MD2A7	MD2A6	MD2A5	MD2A4	MD2A3	MD2A2	MD2A1	MD2A0
R/W	R/W	R/W	R/W	R/W	R/W	R/W	R/W	R/W
At reset	0	0	0	0	0	0	0	0

Bit	Name	Function
15 to 0	MD2A(15:0)	Lower 16 bits (A(15:0)) of DMA destination 2 address for Microphone

(2) MICDEST2REG2 (0x0A00 0026)

Bit	15	14	13	12	11	10	9	8
Name	MD2A31	MD2A30	MD2A29	MD2A28	MD2A27	MD2A26	MD2A25	MD2A24
R/W	R/W	R/W	R/W	R/W	R/W	R/W	R/W	R/W
At reset	0	0	0	0	0	0	0	0

Bit	7	6	5	4	3	2	1	0
Name	MD2A23	MD2A22	MD2A21	MD2A20	MD2A19	MD2A18	MD2A17	MD2A16
R/W	R/W	R/W	R/W	R/W	R/W	R/W	R/W	R/W
At reset	0	0	0	0	0	0	0	0

Bit	Name	Function
15 to 0	MD2A(31:16)	Upper 16 bits (A(31:16)) of DMA destination 2 address for Microphone

These two registers specify the destination memory address of the secondary DMA buffer for the Microphone channel.

12.2.3 Speaker source 1 address registers

(1) SPKRSRC1REG1 (0x0A00 0028)

Bit	15	14	13	12	11	10	9	8
Name	SS1A15	SS1A14	SS1A13	SS1A12	SS1A11	SS1A10	SS1A9	SS1A8
R/W	R/W	R/W	R/W	R/W	R/W	R/W	R/W	R/W
At reset	0	0	0	0	0	0	0	0

Bit	7	6	5	4	3	2	1	0
Name	SS1A7	SS1A6	SS1A5	SS1A4	SS1A3	SS1A2	SS1A1	SS1A0
R/W	R/W	R/W	R/W	R/W	R/W	R/W	R/W	R/W
At reset	0	0	0	0	0	0	0	0

Bit	Name	Function
15 to 0	SS1A(15:0)	Lower 16 bits (A(15:0)) of DMA source 1 address for Speaker

(2) SPKRSRC1REG2 (0x0A00 002A)

Bit	15	14	13	12	11	10	9	8
Name	SS1A31	SS1A30	SS1A29	SS1A28	SS1A27	SS1A26	SS1A25	SS1A24
R/W	R/W	R/W	R/W	R/W	R/W	R/W	R/W	R/W
At reset	0	0	0	0	0	0	0	0

Bit	7	6	5	4	3	2	1	0
Name	SS1A23	SS1A22	SS1A21	SS1A20	SS1A19	SS1A18	SS1A17	SS1A16
R/W	R/W	R/W	R/W	R/W	R/W	R/W	R/W	R/W
At reset	0	0	0	0	0	0	0	0

Bit	Name	Function
15 to 0	SS1A(31:16)	Upper 16 bits (A(31:16)) of DMA source 1 address for Speaker

These two registers specify the source memory address of the primary DMA buffer for the Speaker channel.

12.2.4 Speaker source 2 address registers

(1) SPKRSRC2REG1 (0x0A00 002C)

Bit	15	14	13	12	11	10	9	8
Name	SS2A15	SS2A14	SS2A13	SS2A12	SS2A11	SS2A10	SS2A9	SS2A8
R/W	R/W	R/W	R/W	R/W	R/W	R/W	R/W	R/W
At reset	0	0	0	0	0	0	0	0

Bit	7	6	5	4	3	2	1	0
Name	SS2A7	SS2A6	SS2A5	SS2A4	SS2A3	SS2A2	SS2A1	SS2A0
R/W	R/W	R/W	R/W	R/W	R/W	R/W	R/W	R/W
At reset	0	0	0	0	0	0	0	0

Bit	Name	Function
15 to 0	SS2A(15:0)	Lower 16 bits (A(15:0)) of DMA source 2 address for Speaker

(2) SPKRSRC2REG2 (0x0A00 002E)

Bit	15	14	13	12	11	10	9	8
Name	SS2A31	SS2A30	SS2A29	SS2A28	SS2A27	SS2A26	SS2A25	SS2A24
R/W	R/W	R/W	R/W	R/W	R/W	R/W	R/W	R/W
At reset	0	0	0	0	0	0	0	0

Bit	7	6	5	4	3	2	1	0
Name	SS2A23	SS2A22	SS2A21	SS2A20	SS2A19	SS2A18	SS2A17	SS2A16
R/W	R/W	R/W	R/W	R/W	R/W	R/W	R/W	R/W
At reset	0	0	0	0	0	0	0	0

Bit	Name	Function
15 to 0	SS2A(31:16)	Upper 16 bits (A(31:16)) of DMA source 2 address for Speaker

These two registers specify the source memory address of the secondary DMA buffer for the Speaker channel.

12.2.5 DMARSTREG (0x0A00 0040)

Bit	15	14	13	12	11	10	9	8
Name	Reserved	Reserved	Reserved	Reserved	Reserved	Reserved	Reserved	Reserved
R/W	R	R	R	R	R	R	R	R
At reset	0	0	0	0	0	0	0	0

Bit	7	6	5	4	3	2	1	0
Name	Reserved	Reserved	Reserved	Reserved	Reserved	Reserved	Reserved	DMARST
R/W	R	R	R	R	R	R	R	R/W
At reset	0	0	0	0	0	0	0	1

Bit	Name	Function
15 to 1	Reserved	0 is returned after a read.
0	DMARST	Resets DMA functions 0 : Resets DMA channels 1 : Normal operation

When DMARST bit is written to zero, all active DMA transfers are immediately terminated and the DCU is held in the reset state. While DMARST bit is 0, all DMA requests become pending until this bit is set to 1.

12.2.6 AIUDMAMSKREG (0x0A00 0046)

Bit	15	14	13	12	11	10	9	8
Name	Reserved	Reserved	Reserved	Reserved	Reserved	Reserved	Reserved	Reserved
R/W	R	R	R	R	R	R	R	R
At reset	0	0	0	0	0	0	0	0

Bit	7	6	5	4	3	2	1	0
Name	Reserved	Reserved	Reserved	Reserved	MICMSK	SPKMSK	Reserved	Reserved
R/W	R	R	R	R	R/W	R/W	R	R
At reset	0	0	0	0	0	0	0	0

Bit	Name	Function
15 to 4	Reserved	0 is returned after a read.
3	MICMSK	Masks DMA for Microphone (Audio input) channel 1 : Microphone channel disabled 0 : Microphone channel enabled
2	SPKMSK	Masks DMA for Speaker (Audio output) channel 1 : Speaker channel disabled 0 : Speaker channel enabled
1, 0	Reserved	0 is returned after a read.

12.2.7 MICRCLENREG (0x0A00 0658)

Bit	15	14	13	12	11	10	9	8
Name	MICRL15	MICRL14	MICRL13	MICRL12	MICRL11	MICRL10	MICRL9	MICRL8
R/W	R/W	R/W	R/W	R/W	R/W	R/W	R/W	R/W
At reset	0	0	0	0	0	0	0	0

Bit	7	6	5	4	3	2	1	0
Name	MICRL7	MICRL6	MICRL5	MICRL4	MICRL3	MICRL2	MICRL1	MICRL0
R/W	R/W	R/W	R/W	R/W	R/W	R/W	R/W	R/W
At reset	0	0	0	0	0	0	0	0

Bit	Name	Function
15 to 0	MICRL(15:0)	DMA Record Length for Microphone. MICRL0 bit must be written to zero.

This register defines the number of 16-bit words to be transferred during DMA operation in the Microphone channel.

12.2.8 SPKRLENREG (0x0A00 065A)

Bit	15	14	13	12	11	10	9	8
Name	SPKRL15	SPKRL14	SPKRL13	SPKRL12	SPKRL11	SPKRL10	SPKRL9	SPKRL8
R/W	R/W	R/W	R/W	R/W	R/W	R/W	R/W	R/W
At reset	0	0	0	0	0	0	0	0

Bit	7	6	5	4	3	2	1	0
Name	SPKRL7	SPKRL6	SPKRL5	SPKRL4	SPKRL3	SPKRL2	SPKRL1	SPKRL0
R/W	R/W	R/W	R/W	R/W	R/W	R/W	R/W	R/W
At reset	0	0	0	0	0	0	0	0

Bit	Name	Function
15 to 0	SPKRL(15:0)	DMA Record Length for Speaker. SPKRL0 bit must be written to zero.

This register defines the number of 16-bit words to be transferred during DMA operation in the Speaker channel.

12.2.9 MICDMACFGREG (0x0A00 065E)

Bit	15	14	13	12	11	10	9	8
Name	Reserved	MicDsize1	MicDsize2	MicSrctype	MicDestype	Reserved	Reserved	MicLoad
R/W	R	R	R	R	R	R	R	R/W
At reset	0	0	1	1	0	0	0	0

Bit	7	6	5	4	3	2	1	0
Name	Reserved	Reserved	Reserved	Reserved	Reserved	Reserved	Reserved	Reserved
R/W	R	R	R	R	R	R	R	R
At reset	0	0	0	0	0	0	0	0

Bit	Name	Function
15	Reserved	0 is returned after a read.
14, 13	MicDsize(1:0)	Indicates Microphone channel data size 01 : 16 bits Values other than above do not appear.
12	MicSrctype	Indicates Microphone channel source address type 1 : I/O 0 does not appear.
11	MicDestype	Indicates Microphone channel destination address type 0 : memory 1 does not appear.
10, 9	Reserved	0 is returned after a read.
8	MicLoad	DMA auto load on record length compare for Microphone channel 0 : stop 1 : load When this bit is set to 1, the DCU automatically begins transferring data to the secondary buffer when the primary buffer is full.
7 to 0	Reserved	0 is returned after a read.

12.2.10 SPKDMACFGREG (0x0A00 0660)

Bit	15	14	13	12	11	10	9	8
Name	Reserved	Reserved	Reserved	Reserved	Reserved	Reserved	Reserved	Reserved
R/W	R	R	R	R	R	R	R	R
At reset	0	0	0	0	0	0	0	0

Bit	7	6	5	4	3	2	1	0
Name	Reserved	SpkDsize1	SpkDsize0	SpkSrctype	SpkDestype	Reserved	Reserved	SpkLoad
R/W	R	R	R	R	R	R	R	R/W
At reset	0	0	1	0	1	0	0	0

Bit	Name	Function
15 to 7	Reserved	0 is returned after a read.
6, 5	SpkDsize(1:0)	Indicates Speaker channel data size 01 : 16 bits Values other than above do not appear.
4	SpkSrctype	Indicates Speaker channel source address type 0 : Memory 1 does not appear.
3	SpkDestype	Indicates Speaker channel destination address type 1 : I/O 0 does not appear.
2, 1	Reserved	0 is returned after a read.
0	SpkLoad	DMA auto load on record length compare for Speaker channel 0 : stop 1 : load When this bit is set to 1, the DCU automatically begins transferring data from the secondary buffer when the primary buffer is empty.

12.2.11 DMAITRQREG (0x0A00 0662)

Bit	15	14	13	12	11	10	9	8
Name	Reserved	Reserved	Reserved	Reserved	Reserved	Reserved	Reserved	Reserved
R/W	R	R	R	R	R	R	R	R
At reset	0	0	0	0	0	0	0	0

Bit	7	6	5	4	3	2	1	0
Name	Reserved	Reserved	SpkEOP	MicEOP	Reserved	Reserved	Reserved	Reserved
R/W	R	R	R/W	R/W	R	R/W	R/W	R
At reset	0	0	0	0	0	0	0	0

Bit	Name	Function
15 to 6	Reserved	0 is returned after a read.
5	SpkEOP	Speaker channel end of process (EOP) interrupt status 0 : none 1 : Speaker channel EOP interrupt pending
4	MicEOP	Microphone channel EOP interrupt status 0 : none 1 : Microphone channel EOP interrupt pending
3	Reserved	0 is returned after a read.
2, 1	Reserved	Write 0 when write. 0 is returned after a read.
0	Reserved	0 is returned after a read.

This register indicates interrupt status of each DMA channel by end of process (EOP). Once an interrupt occurs, clear the interrupt request by writing a zero to the corresponding status bit in this register.

12.2.12 DMACLTREG (0x0A00 0664)

Bit	15	14	13	12	11	10	9	8
Name	SpkCNT1	SpkCNT0	MicCNT1	MicCNT0	Reserved	Reserved	Reserved	Reserved
R/W	R/W	R/W	R/W	R/W	R	R	R	R
At reset	0	0	0	0	0	0	0	0

Bit	7	6	5	4	3	2	1	0
Name	Reserved	Reserved	Reserved	Reserved	Reserved	Reserved	Reserved	Reserved
R/W	R/W	R/W	R/W	R/W	R/W	R/W	R/W	R/W
At reset	0	0	0	0	0	0	0	0

Bit	Name	Function
15, 14	SpkCNT(1:0)	Speaker channel source address count control 00 : Increment 01 : Decrement Others : Reserved
13, 12	MicCNT(1:0)	Microphone channel destination address count control 00 : Increment 01 : Decrement Others : Reserved
11 to 8	Reserved	0 is returned after a read.
7 to 0	Reserved	Write 0 when write. 0 is returned after a read.

12.2.13 DMAITMKREG (0x0A00 0666)

Bit	15	14	13	12	11	10	9	8
Name	Reserved	Reserved	Reserved	Reserved	Reserved	Reserved	Reserved	Reserved
R/W	R	R	R	R	R	R	R	R
At reset	0	0	0	0	0	0	0	0

Bit	7	6	5	4	3	2	1	0
Name	Reserved	Reserved	SpkEOPMsk	MicEOPMsk	Reserved	Reserved	Reserved	Reserved
R/W	R	R	R/W	R/W	R	R/W	R/W	R
At reset	0	0	0	0	0	0	0	0

Bit	Name	Function
15 to 6	Reserved	0 is returned after a read.
5	SpkEOPMsk	Speaker channel end of process (EOP) interrupt mask 0 : Disable 1 : Enable
4	MicEOPMsk	Microphone channel EOP interrupt mask 0 : Disable 1 : Enable
3	Reserved	0 is returned after a read.
2, 1	Reserved	Write 0 when write. 0 is returned after a read.
0	Reserved	0 is returned after a read.

CHAPTER 13 CLOCKED SERIAL INTERFACE UNIT (CSI)

13.1 Overview

The CSI manages communication via a synchronous serial bus. The CSI has the following key characteristics:

- Slave-only synchronous serial interface
- Able to transmit and receive data simultaneously
- Supports fixed 8-bit character length
- Supports back-to-back character transmission and reception
- Continuous transfer mode for auto scanning of peripherals
- Programmable clock phase and clock polarity
- Supports burst lengths of 1 to 65535 bits

The CSI interface is enabled on the following GPIO pins:

GPIO Pin	CSI Signal	Definition
GPIO10	FRM	Optional multifunction control input. In one mode, FRM determines data direction (transmit or receive). In the other mode, FRM enables (low level) or inhibits (high level) transmissions.
GPIO2	SCK	Serial clock input (Maximum frequency: 1.6 MHz)
GPIO1	SO	Serial data output
GPIO0	SI	Serial data input

13.2 Operation of CSI

13.2.1 Transmit / receive operations

Transmit and receive operations are initiated by an external master to drive the serial clock SCK. The characteristics of the protocol are controlled by the CSIMODE register, in particular by CKPOL, CKMD, FRMEN, and FRMMD bits. CKPOL and CKMD bits control the relationship between data driven on SO and SI, and the phase of the serial clock input to SCK. FRMEN and FRMMD bits enable and control the FRM input.

13.2.2 SCK phase and CSI transfer timing

The external master drives SCK and SI and samples data driven on SO. The CSI supports 4 basic operating modes for SCK depending on the settings of CKPOL and CKMD bits. These are illustrated in the following figure.

Figure 13-1. SCK and SI/SO Relationship

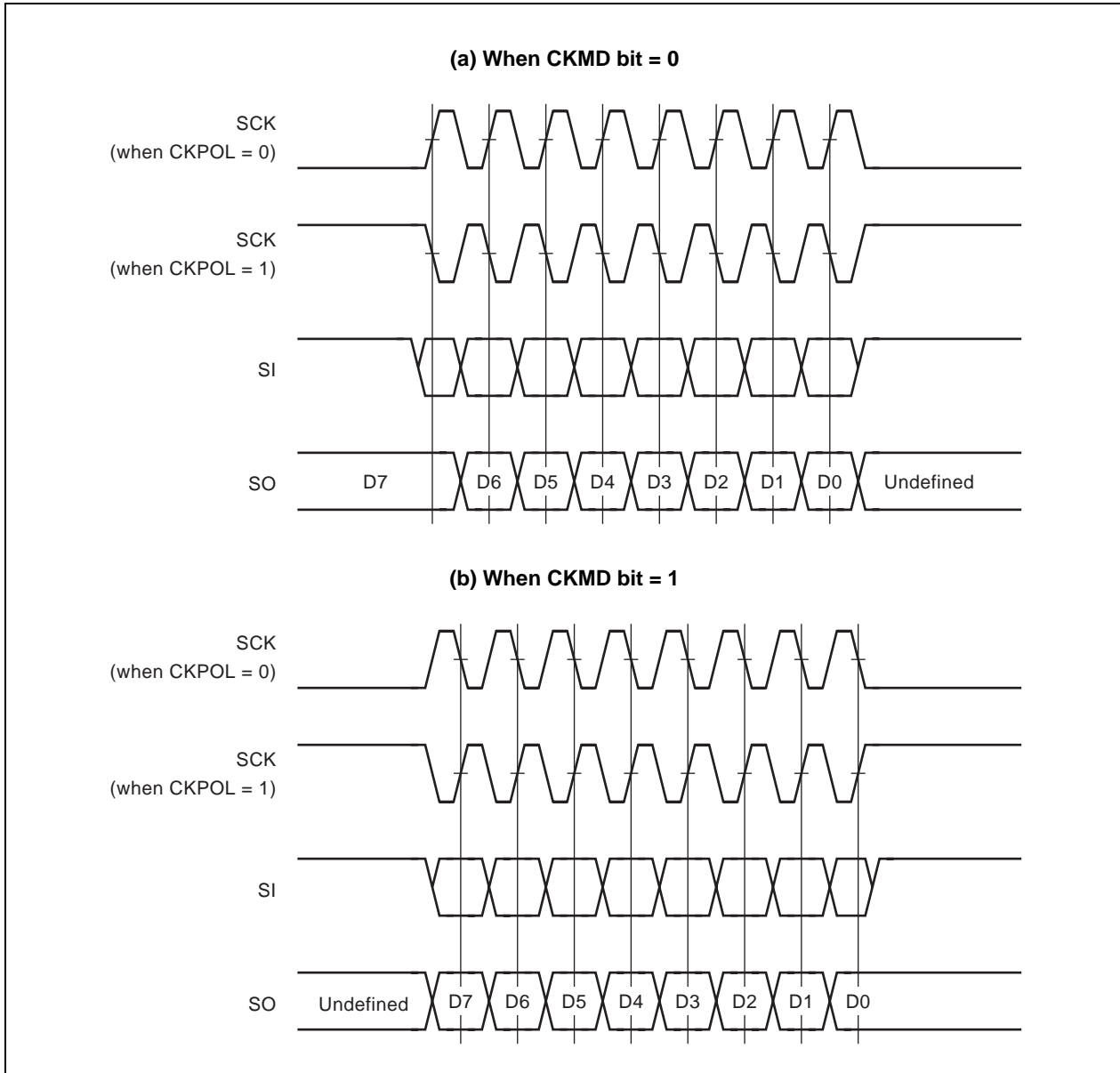

This figure illustrates CSI cycles when the FRM input is disabled (FRMEN bit = 0) or configured to provide direction control (FRMEN bit = 1 and FRMMD bit = 0). When FRMEN bit = 1 and FRMMD bit = 1, SO is driven as high impedance during a high level input to FRM.

(1) When CKMD = 0 and CKPOL = 0

In this mode, data bit D7 is driven as valid prior to the first rising edge of SCK. Thereafter, data is transmitted at the falling edge of SCK and sampled by the VR4181 or the external master at the rising edge of SCK.

(2) When CKMD = 0 and CKPOL = 1

In this mode, data bit D7 is driven as valid and then sampled at the first falling edge of SCK. Thereafter, data is transmitted at the rising edge of SCK and sampled by the VR4181 or the external master at the falling edge of SCK.

(3) When CKMD = 1 and CKPOL = 0

In this mode, data bit D7 is driven valid on the first rising edge of SCK and sampled at the first falling edge of SCK. Thereafter, data is transmitted at the rising edge of SCK and sampled by the VR4181 or the external master at the falling edge of SCK.

(4) When CKMD = 1 and CKPOL = 1

In this mode, data bit D7 is driven as valid at the first falling edge of SCK and sampled at the first rising edge of SCK. Thereafter, data is transmitted at the falling edge of SCK and sampled by the VR4181 or the external master at the rising edge of SCK.

13.2.3 CSI Transfer Types**(1) Burst mode**

Burst mode is supported for both transmit and receive transfers. Burst lengths for transmit and receive are independently programmable and can be set from 1 to 65535 bits. The Transmit and Receive shift registers are both 8-bit lengths. During burst mode, when the receive shift register goes “full”, the data is automatically transferred to the receive FIFO. When the transmit shift register goes “empty”, it is automatically reloaded from the transmit FIFO.

Once the burst length has been set and the burst transaction enabled, the CSI behaves as follows:

The CSI begins tracking the number of bits transmitted and/or received. At the end of each bit transfer, the bit count is updated and compared to the corresponding burst length value (transmit and/or receive). If the number of bits transferred is equal to the burst length, the CSI shift register is halted.

If the transfer is a reception, the contents of the shift register will be copied to the receive FIFO, a Receive Burst End interrupt request will be generated if unmasked, and additional activities on the SCK input will be ignored. If the transfer is a transmission, a Transmit Burst End interrupt request will be generated if unmasked and additional SCK cycles will cause the data remaining in the transmit shift register to be output on SO.

(2) Continuous mode

Continuous mode transfers are always defined as 8-bit fixed length transfers. In continuous mode, software must control the flow of data between the VR4181 and the external master.

When continuous mode is enabled and the receive shift register goes “full”, the data is automatically transferred to the receive FIFO. When the transmit shift register goes “empty”, it is automatically reloaded from the transmit FIFO.

13.2.4 Transmit and receive FIFOs

The CSI contains two 8-deep 16-bit FIFOs. One is for transmission and the other for reception. The transmit and receive shift registers access the FIFOs by 8 bits at a time. The CPU accesses the FIFOs in either 8-bit or 16-bit units.

The threshold of each FIFO is independently programmable. For the transmit FIFO, an interrupt request is generated to inform the CPU that 1, 2, or 4 16-bit words are empty in the FIFO. For the receive FIFO, an interrupt request is generated to inform the CPU that 1, 2, or 4 16-bit words can be read from the FIFO.

The FIFO control logic can also generate interrupt requests to signal an overrun condition for the receive FIFO or an underrun condition for the transmit FIFO. An overrun occurs when the receive shift register attempts to transfer data to a location in the FIFO which has not be read by the DMA unit or the CPU. An under-run condition occurs when the transmit shift register attempts to load a value from the FIFO which has not been updated by the DMA unit or the CPU.

(1) Overrun / underrun errors

When an overrun error occurs, the receive FIFO logic generates an overrun interrupt request if unmasked, and overwrites the next location in the FIFO with the contents of the receive shift register.

When an underrun error occurs, the transmit FIFO logic generates an underrun interrupt request if unmasked, and reloads the transmit shift register with the contents of the next location in the FIFO.

The software must attempt to recover the data loss caused by the overrun or underrun error.

13.3 CSI Registers

The CSI provides the following registers:

Table 13-1. CSI Registers

Address	R/W	Register symbol	Function
0x0B00 0900	R/W	CSIMODE	CSI mode register
0x0B00 0902	R	CSIRXDATA	CSI receive data register
0x0B00 0904	R/W	CSITXDATA	CSI transmit data register
0x0B00 0906	R/W	CSILSTAT	CSI line status register
0x0B00 0908	R/W	CSIINTMSK	CSI interrupt mask register
0x0B00 090A	R/W	CSIINTSTAT	CSI interrupt status register
0x0B00 090C	R/W	CSITXBLEN	CSI transmit burst length register
0x0B00 090E	R/W	CSIRXBLEN	CSI receive burst length register

13.3.1 CSIMODE (0x0B00 0900)

(1/2)

Bit	15	14	13	12	11	10	9	8
Name	FRMEN	TXEN	TXBMD	TXCLR	Reserved	RXEN	RXBMD	RXCLR
R/W	R/W	R/W	R/W	R/W	R	R/W	R/W	R/W
RTCRST	0	0	0	0	0	0	0	0
Other resets	0	0	0	0	0	0	0	0

Bit	7	6	5	4	3	2	1	0
Name	FRMMD	CKPOL	CKMD	Reserved	Reserved	Reserved	Reserved	LSBMSB
R/W	R/W	R/W	R/W	R	R	R	R	R/W
RTCRST	0	0	0	0	0	0	0	0
Other resets	0	0	0	0	0	0	0	0

Bit	Name	Function
15	FRMEN	CSI FRM enable 0 : FRM input disabled. FRM signal ignored. 1 : FRM input enabled. Mode is set by FRMMD bit.
14	TXEN	CSI Transmit Enable 0 : Disable transmit operations 1 : Enable transmit operations
13	TXBMD	CSI Transmit Burst Mode 0 : Transmit cycles defined as continuous mode 1 : Transmit cycles defined as burst mode
12	TXCLR	CSI Transmit Buffer Clear 0 : Enable transmit shift register and FIFO 1 : Hold transmit shift register in reset and reset FIFO
11	Reserved	0 is returned after read
10	RXEN	CSI Receive Enable 0 : Disable receive operations 1 : Enable receive operations
9	RXBMD	CSI Receive Burst Mode 0 : Receive cycles defined as continuous mode 1 : Receive cycles defined as burst mode
8	RXCLR	CSI Receive Buffer Clear 0 : Enable receive shift register and FIFO 1 : Hold receive shift register in reset and reset FIFO
7	FRMMD	FRM mode 0 : FRM controls transfer directions (receive = 1, transmit = 0) 1 : FRM enables transfers (transmit/receive enabled when FRM = 0)

(2/2)

Bit	Name	Function
6	CKPOL	CSI clock polarity ^{Note} 0 : SCK is active high (1st transition is low to high) 1 : SCK is active low (1st transition is high to low)
5	CKMD	CSI clocking mode ^{Note} 0 : Character data is valid prior to the 1st transition of SCK 1 : Character data is valid at the 1st transition of SCK
4 to 1	Reserved	0 is returned after read
0	LSBMSB	Transmit/receive mode bit ordering 0 : Bit 7 is the first bit transmitted or received (MSB mode) 1 : Bit 0 is the first bit transmitted or received (LSB mode)

Note TXCLR and RXCLR bits must be cleared after changing CKPOL or CKMD bit.

13.3.2 CSIRXDATA (0x0B00 0902)

Bit	15	14	13	12	11	10	9	8
Name	RXD15	RXD14	RXD13	RXD12	RXD11	RXD10	RXD9	RXD8
R/W	R	R	R	R	R	R	R	R
RTCRST	0	0	0	0	0	0	0	0
Other resets	0	0	0	0	0	0	0	0

Bit	7	6	5	4	3	2	1	0
Name	RXD7	RXD6	RXD5	RXD4	RXD3	RXD2	RXD1	RXD0
R/W	R	R	R	R	R	R	R	R
RTCRST	0	0	0	0	0	0	0	0
Other resets	0	0	0	0	0	0	0	0

Bit	Name	Function
15 to 0	RXD(15:0)	CSI receive data. CSI data received on SI pin is read through these data bits.

13.3.3 CSITXDATA (0x0B00 0904)

Bit	15	14	13	12	11	10	9	8
Name	TXD15	TXD14	TXD13	TXD12	TXD11	TXD10	TXD9	TXD8
R/W	R/W	R/W	R/W	R/W	R/W	R/W	R/W	R/W
RTCRST	0	0	0	0	0	0	0	0
Other resets	0	0	0	0	0	0	0	0

Bit	7	6	5	4	3	2	1	0
Name	TXD7	TXD6	TXD5	TXD4	TXD3	TXD2	TXD1	TXD0
R/W	R/W	R/W	R/W	R/W	R/W	R/W	R/W	R/W
RTCRST	0	0	0	0	0	0	0	0
Other resets	0	0	0	0	0	0	0	0

Bit	Name	Function
15 to 0	TXD(15:0)	CSI transmit data. CSI data written to these bits is transmitted on the SO pin.

13.3.4 CSILSTAT (0x0B00 0906)

(1/2)

Bit	15	14	13	12	11	10	9	8
Name	TFIFOT1	TFIFOT0	Reserved	Reserved	Reserved	TXFIFO	TXFIFOE	TXBUSY
R/W	R/W	R/W	R	R	R	R	R	R
RTCRST	0	0	0	0	0	0	1	0
Other resets	0	0	0	0	0	0	1	0

Bit	7	6	5	4	3	2	1	0
Name	RFIFOT1	RFIFOT0	Reserved	FRMDIR	Reserved	RXFIFO	RXFIFOE	RXBUSY
R/W	R/W	R/W	R	R	R	R	R	R
RTCRST	0	0	0	0	0	0	0	0
Other resets	0	0	0	0	0	0	0	0

Bit	Name	Function
15, 14	TFIFOT(1:0)	CSI transmit FIFO threshold. These bits select when transmit FIFO empty status is notified. 00 : 1 or more words empty in transmit FIFO 01 : 2 or more words empty in transmit FIFO 10 : 4 or more words empty in transmit FIFO 11 : Reserved
13 to 11	Reserved	0 is returned after read
10	TXFIFO	CSI transmit FIFO full status. This bit is set to 1 when the transmit FIFO contains no free space. 0 : Transmit FIFO not full 1 : Transmit FIFO full
9	TXFIFOE	CSI transmit FIFO empty status. This bit is set to 1 when the transmit FIFO goes empty as defined by TFIFOT bits. 0 : Transmit FIFO not empty 1 : Transmit FIFO empty
8	TXBUSY	CSI transmit shift register status 0 : Transmit shift register idle 1 : Character transmission in progress
7, 6	RFIFOT(1:0)	CSI receive FIFO threshold. These bits select when receive FIFO full status is notified. 00 : 1 or more words valid in receive FIFO 01 : 2 or more words valid in receive FIFO 10 : 4 or more words valid in receive FIFO 11 : Reserved
5	Reserved	0 is returned after read

Bit	Name	Function
4	FRMDIR	FRM input pin status 0 : Low (transmit direction) 1 : High (receive direction)
3	Reserved	0 is returned after read
2	RXFIFO	CSI receive FIFO full status. This bit is set to 1 when the receive FIFO goes full as defined by RFIFOT bits. 0 : Receive FIFO not full 1 : Receive FIFO full
1	RXFIFOE	CSI receive FIFO empty status. This bit is set to 1 when the receive FIFO contains no valid data. 0 : Receive FIFO not empty 1 : Receive FIFO empty
0	RXBUSY	CSI receive shift register status 0 : Receive shift register idle 1 : Character reception in progress

13.3.5 CSIINTMSK (0x0B00 0908)

Bit	15	14	13	12	11	10	9	8
Name	Reserved	Reserved	Reserved	Reserved	MUNDRN	MTXBEND	MTXFIFOE	MTXBUSY
R/W	R	R	R	R	R/W	R/W	R/W	R/W
RTCRST	0	0	0	0	1	1	1	1
Other resets	0	0	0	0	1	1	1	1

Bit	7	6	5	4	3	2	1	0
Name	Reserved	Reserved	Reserved	Reserved	MOVRRN	MRXBEND	MRXFIFOE	MRXBUSY
R/W	R	R	R	R	R/W	R/W	R/W	R/W
RTCRST	0	0	0	0	1	1	1	1
Other resets	0	0	0	0	1	1	1	1

Bit	Name	Function
15 to 12	Reserved	0 is returned after read
11	MUNDRN	Mask transmit FIFO underrun interrupt requests 0 : Underrun interrupt requests unmasked 1 : Underrun interrupt requests masked
10	MTXBEND	Mask Transmit Burst End interrupt requests 0 : Transmit Burst End interrupt requests unmasked 1 : Transmit Burst End interrupt requests masked
9	MTXFIFOE	Mask Transmit FIFO Empty interrupt requests 0 : Transmit FIFO Empty interrupt requests unmasked 1 : Transmit FIFO Empty interrupt requests masked
8	MTXBUSY	Mask Transmit Shift Register Busy interrupt requests 0 : Transmit Shift Register Busy interrupt requests unmasked 1 : Transmit Shift Register Busy interrupt requests masked
7 to 4	Reserved	0 is returned after read
3	MOVRRN	Mask Receive FIFO Overrun interrupt requests 0 : Receive FIFO Overrun interrupt requests unmasked 1 : Receive FIFO Overrun interrupt requests masked
2	MRXBEND	Mask Receive Burst End interrupt requests 0 : Receive Burst End interrupt requests unmasked 1 : Receive Burst End interrupt requests masked
1	MRXFIFOE	Mask Receive FIFO Full interrupt requests 0 : Receive FIFO Full interrupt requests unmasked 1 : Receive FIFO Full interrupt requests masked
0	MRXBUSY	Mask Receive Shift Register Busy interrupt requests 0 : Receive Shift Register Busy interrupt requests unmasked 1 : Receive Shift Register Busy interrupt requests masked

13.3.6 CSIINTSTAT (0x0B00 090A)

(1/2)

Bit	15	14	13	12	11	10	9	8
Name	Reserved	Reserved	Reserved	Reserved	URNINT	TXBEINT	TXFEINT	TXBSYINT
R/W	R	R	R	R	R/W	R/W	R/W	R/W
RTCRST	0	0	0	0	0	0	0	0
Other resets	0	0	0	0	0	0	0	0

Bit	7	6	5	4	3	2	1	0
Name	Reserved	Reserved	Reserved	Reserved	ORNINT	RXBEINT	RXFFINT	RXSYINT
R/W	R	R	R	R	R/W	R/W	R/W	R/W
RTCRST	0	0	0	0	0	0	0	0
Other resets	0	0	0	0	0	0	0	0

Bit	Name	Function
15 to 12	Reserved	0 is returned after read
11	URNINT	Transmit FIFO Underrun interrupt request status 0 : No Underrun interrupt request pending 1 : Underrun interrupt request pending This bit is cleared by writing 1.
10	TXBEINT	Transmit Burst End interrupt request status 0 : No Transmit Burst End interrupt request pending 1 : Transmit Burst End interrupt request pending This bit is cleared by writing 1.
9	TXFEINT	Transmit FIFO Empty interrupt request status 0 : No Transmit FIFO Empty interrupt request pending 1 : Transmit FIFO Empty interrupt request pending This bit is cleared by writing 1.
8	TXBSYINT	Transmit Shift Register Busy interrupt request status 0 : No Transmit Shift Register Busy interrupt request pending 1 : Transmit Shift Register Busy interrupt request pending This bit is cleared by writing 1.
7 to 4	Reserved	0 is returned after read
3	ORNINT	Receive FIFO Overrun interrupt request status 0 : No Receive FIFO Overrun interrupt request pending 1 : Receive FIFO Overrun interrupt request pending This bit is cleared by writing 1.

(2/2)

Bit	Name	Function
2	RXBEINT	Receive Burst End interrupt request status 0 : No Receive Burst End interrupt request pending 1 : Receive Burst End interrupt request pending This bit is cleared by writing 1.
1	RXFFINT	Receive FIFO Full interrupt request status 0 : No Receive FIFO Full interrupt request pending 1 : Receive FIFO Full interrupt request pending This bit is cleared by writing 1.
0	RXBSYINT	Receive Shift Register Busy interrupt request status 0 : No Receive Shift Register Busy interrupt request pending 1 : Receive Shift Register Busy interrupt request pending This bit is cleared by writing 1.

13.3.7 CSITXBLEN (0x0B00 090C)

Bit	15	14	13	12	11	10	9	8
Name	TXBLN15	TXBLN14	TXBLN13	TXBLN12	TXBLN11	TXBLN10	TXBLN9	TXBLN8
R/W	R/W	R/W	R/W	R/W	R/W	R/W	R/W	R/W
RTCST	0	0	0	0	0	0	0	0
Other resets	0	0	0	0	0	0	0	0

Bit	7	6	5	4	3	2	1	0
Name	TXBLN7	TXBLN6	TXBLN5	TXBLN4	TXBLN3	TXBLN2	TXBLN1	TXBLN0
R/W	R/W	R/W	R/W	R/W	R/W	R/W	R/W	R/W
RTCST	0	0	0	0	0	0	0	0
Other resets	0	0	0	0	0	0	0	0

Bit	Name	Function
15 to 0	TXBLN(15:0)	<p>Transmit burst length. These bits determine the number of bits transmitted during one burst cycle.</p> <p>0x0000 : Reserved 0x0001 : 1 bit 0x0002 : 2 bits : : 0x00FD : 253 bits 0x00FE : 254 bits 0x00FF : 255 bits : : 0xFFFD : 65533 bits 0xFFFE : 65534 bits 0xFFFF : 65535 bits</p>

13.3.8 CSIRXBLN (0x0B00 090E)

Bit	15	14	13	12	11	10	9	8
Name	RXBLN15	RXBLN14	RXBLN13	RXBLN12	RXBLN11	RXBLN10	RXBLN9	RXBLN8
R/W	R/W	R/W	R/W	R/W	R/W	R/W	R/W	R/W
RTCRST	0	0	0	0	0	0	0	0
Other resets	0	0	0	0	0	0	0	0

Bit	7	6	5	4	3	2	1	0
Name	RXBLN7	RXBLN6	RXBLN5	RXBLN4	RXBLN3	RXBLN2	RXBLN1	RXBLN0
R/W	R/W	R/W	R/W	R/W	R/W	R/W	R/W	R/W
RTCRST	0	0	0	0	0	0	0	0
Other resets	0	0	0	0	0	0	0	0

Bit	Name	Function
15 to 0	RXBLN(15:0)	<p>Receive burst length. These bits determine the number of bits received during one burst cycle.</p> <p>0x0000 : Reserved 0x0001 : 1 bit 0x0002 : 2 bits : : 0x00FD : 253 bits 0x00FE : 254 bits 0x00FF : 255 bits : : 0xFFFFD : 65533 bits 0xFFFFE : 65534 bits 0xFFFFF : 65535 bits</p>

CHAPTER 14 INTERRUPT CONTROL UNIT (ICU)

14.1 Overview

The ICU collects interrupt requests from the various on-chip peripheral units and transfers them with internal interrupt request signals (Int0, Int1, Int2, Int3, and NMI) to the CPU core.

The signals used to notice interrupt requests to the CPU are as below.

NMI: battint_intr only. Switching between NMI and Int0 is enabled according to NMIREG register's settings. Because NMI's interrupt masking cannot be controlled by means of software, switch to Int0 to mask battint_intr.

Int3: Not used (fixed to 1 (inactive))

Int2: rtc_long2_intr only (RTCLong2 Timer)

Int1: rtc_long1_intr only (RTCLong1 Timer)

Int0: All other interrupts. For details of the interrupt sources, see **14.2 Register Set**.

How an interrupt request is notified to the CPU core is shown below.

If an interrupt request occurs in the peripheral units, the corresponding bit in the interrupt indication register of Level 2 (xxxINTREG) is set to 1. The interrupt indication register is ANDed bit-wise with the corresponding interrupt mask register of Level 2 (MxxxINTREG). If the occurred interrupt request is enabled (set to 1) in the mask register, the interrupt request is notified to the interrupt indication register of Level 1 (SYSINTREG) and the corresponding bit is set to 1. At this time, the interrupt requests from the same register of Level 2 are notified to the SYSINTREG as a single interrupt request.

Interrupt requests from some units directly set their corresponding bits in the SYSINTREG.

The SYSINTREG is ANDed bit-wise with the interrupt mask register of Level 1 (MSYSINTREG). If the interrupt request is enabled by MSYSINTREG (set to 1), a corresponding interrupt request signal is output from the ICU to the CPU core. battintr is connected to the NMI or Int0 signal of the CPU core (selected by setting of NMIREG). rtc_long signals are connected to the Int2 or Int1 signal of the CPU core. The other interrupt requests are connected to the Int0 signal of the CPU core as a single interrupt request.

The following figure shows an outline of interrupt control in the ICU.

Figure 14-1. Peripheral Logic Block Assignment for Interrupt Registers

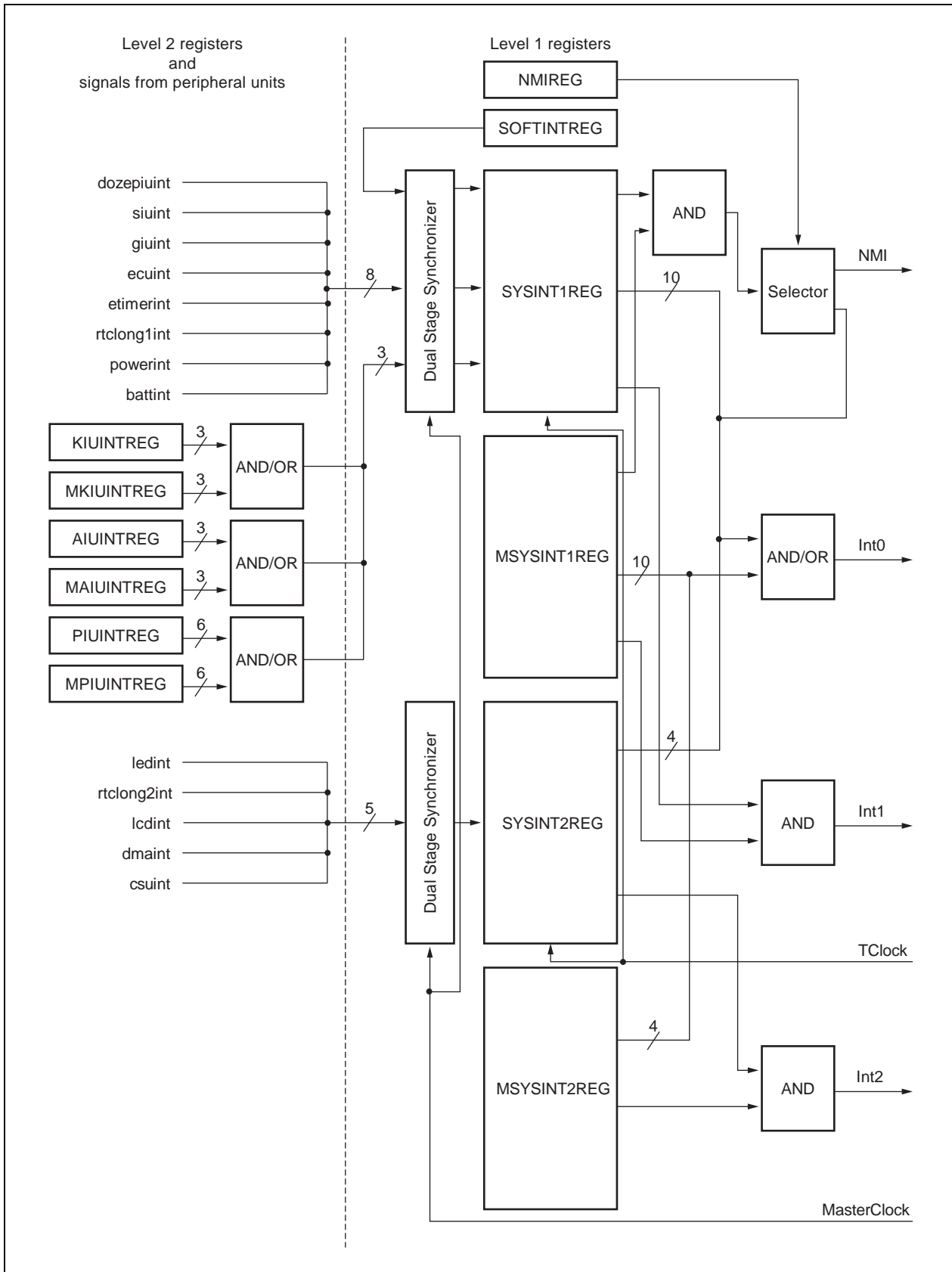

14.2 Register Set

Table 14-1. ICU Registers

Address	R/W	Register symbol	Function
0x0A00 0080	R	SYSINT1REG	Level 1 system register 1
0x0A00 008C	R/W	MSYNT1REG	Level 1 mask system register 1
0x0A00 0098	R/W	NMIREG	NMI register
0x0A00 009A	R/W	SOFTINTREG	Software interrupt register
0x0A00 0200	R	SYSINT2REG	Level 1 system register 2
0x0A00 0206	R/W	MSYSINT2REG	Level 1 mask system register 2
0x0B00 0082	R	PIUINTREG	Level 2 PIU register
0x0B00 0084	R	AIUINTREG	Level 2 AIU register
0x0B00 008E	R/W	MPIUINTREG	Level 2 mask PIU register
0x0B00 0090	R/W	MAIUINTREG	Level 2 mask AIU register
0x0B00 0092	R/W	MKIUINTREG	Level 2 mask KIU register
0x0B00 0198	R	KIUINTREG	Level 2 KIU register

14.2.1 SYSINT1REG (0x0A00 0080)

(1/2)

Bit	15	14	13	12	11	10	9	8
Name	Reserved	Reserved	DOZEPIU INTR	Reserved	SOFTINTR	Reserved	SIUINTR	GIUINTR
R/W	R	R	R	R	R	R	R	R
RTCRST	0	0	0	0	0	0	0	0
Other resets	0	0	0	0	0	0	0	0

Bit	7	6	5	4	3	2	1	0
Name	KIUINTR	AIUINTR	PIUINTR	Reserved	ETIMER INTR	RTCL1 INTR	POWER INTR	BATINTR
R/W	R	R	R	R	R	R	R	R
RTCRST	0	0	0	0	0	0	0	0
Other resets	0	0	0	0	0	0	0	0

Bit	Name	Function
15, 14	Reserved	0 is returned when read
13	DOZEPIUINTR	PIU interrupt request during Suspend mode 0 : Not occurred 1 : Occurred
12	Reserved	0 is returned when read
11	SOFTINTR	Software interrupt request 0 : Not occurred 1 : Occurred
10	Reserved	0 is returned when read
9	SIUINTR	SIU interrupt request 0 : Not occurred 1 : Occurred
8	GIUINTR	GIU interrupt request 0 : Not occurred 1 : Occurred
7	KIUINTR	KIU interrupt request 0 : Not occurred 1 : Occurred
6	AIUINTR	AIU interrupt request 0 : Not occurred 1 : Occurred

Bit	Name	Function
5	PIUINTR	PIU interrupt request 0 : Not occurred 1 : Occurred
4	Reserved	0 is returned when read
3	ETIMERINTR	ETIMER interrupt request 0 : Not occurred 1 : Occurred
2	RTCL1INTR	RTC Long 1 interrupt request 0 : Not occurred 1 : Occurred
1	POWERINTR	Power SW interrupt request 0 : Not occurred 1 : Occurred
0	BATINTR	Battery low interrupt request 0 : Not occurred 1 : Occurred

This register indicates level-1 interrupt requests' status.

14.2.2 MSYSINT1REG (0x0A00 008C)

(1/2)

Bit	15	14	13	12	11	10	9	8
Name	Reserved	Reserved	MDOZEPIU INTR	Reserved	MSOFT INTR	Reserved	MSIUINTR	MGIUINTR
R/W	R	R	R/W	R	R/W	R	R/W	R/W
RTCRST	0	0	0	0	0	0	0	0
Other resets	0	0	0	0	0	0	0	0

Bit	7	6	5	4	3	2	1	0
Name	MKIUINTR	MAIUINTR	MPIUINTR	Reserved	METIMER INTR	MRTCL1 INTR	MPOWER INTR	MBATINTR
R/W	R/W	R/W	R/W	R	R/W	R/W	R/W	R/W
RTCRST	0	0	0	0	0	0	0	0
Other resets	0	0	0	0	0	0	0	0

Bit	Name	Function
15, 14	Reserved	0 is returned when read
13	MDOZEPIUINTR	Enables PIU interrupt during Suspend mode 0 : Disable 1 : Enable
12	Reserved	0 is returned when read
11	MSOFTINTR	Enables software interrupt 0 : Disable 1 : Enable
10	Reserved	0 is returned when read
9	MSIUINTR	Enables SIU interrupt 0 : Disable 1 : Enable
8	MGIUINTR	Enables GIU interrupt 0 : Disable 1 : Enable
7	MKIUINTR	Enables KIU interrupt 0 : Disable 1 : Enable
6	MAIUINTR	Enables AIU interrupt 0 : Disable 1 : Enable

Bit	Name	Function
5	MPIUINTR	Enables PIU interrupt 0 : Disable 1 : Enable
4	Reserved	0 is returned when read
3	METIMERINTR	Enables ETIMER interrupt 0 : Disable 1 : Enable
2	MRTCL1INTR	Enables RTC Long 1 interrupt 0 : Disable 1 : Enable
1	MPOWERINTR	Enables Power SW interrupt 0 : Disable 1 : Enable
0	MBATINTR	Enables battery low interrupt 0 : Disable 1 : Enable

This register is used to enable/disable level-1 interrupts.

14.2.3 NMIREG (0x0A00 0098)

Bit	15	14	13	12	11	10	9	8
Name	Reserved	Reserved	Reserved	Reserved	Reserved	Reserved	Reserved	Reserved
R/W	R	R	R	R	R	R	R	R
RTCRST	0	0	0	0	0	0	0	0
Other resets	0	0	0	0	0	0	0	0

Bit	7	6	5	4	3	2	1	0
Name	Reserved	Reserved	Reserved	Reserved	Reserved	Reserved	Reserved	NMIORINT
R/W	R	R	R	R	R	R	R	R/W
RTCRST	0	0	0	0	0	0	0	0
Other resets	0	0	0	0	0	0	0	0

Bit	Name	Function
15 to 1	Reserved	0 is returned when read
0	NMIORINT	Battery low interrupt request routing 0 : NMI 1 : Int0

This register is used to set the type of interrupt request signal used to notify the Vr4110 CPU core when a battery low interrupt request has occurred.

14.2.4 SOFTINTREG (0x0A00 009A)

Bit	15	14	13	12	11	10	9	8
Name	Reserved	Reserved	Reserved	Reserved	Reserved	Reserved	Reserved	Reserved
R/W	R	R	R	R	R	R	R	R
RTCST	0	0	0	0	0	0	0	0
Other resets	0	0	0	0	0	0	0	0

Bit	7	6	5	4	3	2	1	0
Name	Reserved	Reserved	Reserved	Reserved	Reserved	Reserved	Reserved	SOFTINTR
R/W	R	R	R	R	R	R	R	W
RTCST	0	0	0	0	0	0	0	0
Other resets	0	0	0	0	0	0	0	0

Bit	Name	Function
15 to 1	Reserved	0 is returned when read
0	SOFTINTR	Set/clear a software interrupt request. This bit is a write-only bit. Software interrupt request pending status is reported in the SYSINT1REG (0x0A000080). 0 : Clear 1 : Set

This register is used to set a software interrupt request.

14.2.5 SYSINT2REG (0x0A00 0200)

Bit	15	14	13	12	11	10	9	8
Name	Reserved	Reserved	Reserved	Reserved	Reserved	Reserved	Reserved	Reserved
R/W	R	R	R	R	R	R	R	R
RTCRST	0	0	0	0	0	0	0	0
Other resets	0	0	0	0	0	0	0	0

Bit	7	6	5	4	3	2	1	0
Name	Reserved	LCDINTR	DMAINTR	Reserved	CSUINTR	ECUINTR	LEDINTR	RTCL2INTR
R/W	R	R	R	R	R	R	R	R
RTCRST	0	0	0	0	0	0	0	0
Other resets	0	0	0	0	0	0	0	0

Bit	Name	Function
15 to 7	Reserved	0 is returned when read
6	LCDINTR	LCD interrupt request 0 : Not occurred 1 : Occurred
5	DMAINTR	DMA interrupt request 0 : Not occurred 1 : Occurred
4	Reserved	0 is returned when read
3	CSUINTR	CSI interrupt request 0 : Not occurred 1 : Occurred
2	ECUINTR	CompactFlash interrupt request 0 : Not occurred 1 : Occurred
1	LEDINTR	LED interrupt request 0 : Not occurred 1 : Occurred
0	RTCL2INTR	RTC Long 2 interrupt request 0 : Not occurred 1 : Occurred

This register indicates level-1 interrupt requests' status.

14.2.6 MSYSINTREG2 (0x0A00 0206)

Bit	15	14	13	12	11	10	9	8
Name	Reserved	Reserved	Reserved	Reserved	Reserved	Reserved	Reserved	Reserved
R/W	R	R	R	R	R	R	R	R
RTCST	0	0	0	0	0	0	0	0
Other resets	0	0	0	0	0	0	0	0

Bit	7	6	5	4	3	2	1	0
Name	Reserved	MLCDINTR	MDMAINTR	Reserved	MCSUINTR	MECUINTR	MLEDINTR	MRTCL2 INTR
R/W	R	R/W	R/W	R/W	R/W	R/W	R/W	R/W
RTCST	0	0	0	0	0	0	0	0
Other resets	0	0	0	0	0	0	0	0

Bit	Name	Function
15 to 7	Reserved	0 is returned when read
6	MLCDINTR	Enables LCD interrupt 0 : Disable 1 : Enable
5	MDMAINTR	Enables DMA interrupt 0 : Disable 1 : Enable
4	Reserved	Write 0 when write. 0 is returned when read
3	MCSUINTR	Enables CSI interrupt 0 : Disable 1 : Enable
2	MECUINTR	Enables CompactFlash interrupt 0 : Disable 1 : Enable
1	MLEDINTR	Enables LED interrupt 0 : Disable 1 : Enable
0	MRTCL2INTR	Enables RTC Long 2 interrupt 0 : Disable 1 : Enable

This register is used to enable/disable level-1 interrupts.

14.2.7 PIUINTREG (0x0B00 0082)

Bit	15	14	13	12	11	10	9	8
Name	Reserved	Reserved	Reserved	Reserved	Reserved	Reserved	Reserved	Reserved
R/W	R	R	R	R	R	R	R	R
RTCRST	0	0	0	0	0	0	0	0
Other resets	0	0	0	0	0	0	0	0

Bit	7	6	5	4	3	2	1	0
Name	Reserved	PADCMD INTR	PADADP INTR	PADPAGE1 INTR	PADPAGE0 INTR	PADDLOST INTR	Reserved	PENCHG INTR
R/W	R	R	R	R	R	R	R	R
RTCRST	0	0	0	0	0	0	0	0
Other resets	0	0	0	0	0	0	0	0

Bit	Name	Function
15 to 7	Reserved	0 is returned when read
6	PADCMDINTR	PIU command scan interrupt request. This interrupt request occurs when command scan detects valid data. 0 : Not occurred 1 : Occurred
5	PADADPINTR	PIU AD Port Scan interrupt request. This interrupt request occurs when AD Port Scan detects a set of valid data. 0 : Not occurred 1 : Occurred
4	PADPAGE1INTR	PIU data buffer page 1 interrupt request. This interrupt request occurs when a set of valid data is stored in page 1 of data buffer. 0 : Not occurred 1 : Occurred
3	PADPAGE0INTR	PIU data buffer page 0 interrupt request. This interrupt request occurs when a set of valid data is stored in page 0 of data buffer. 0 : Not occurred 1 : Occurred
2	PADDLOSTINTR	A/D data timeout. This interrupt request occurs when a set of data is not detected within specified time. 0 : Not occurred 1 : Occurred
1	Reserved	0 is returned when read
0	PENCHGINTR	Change in touch panel contact status 0 : Not occurred 1 : Occurred

This register indicates when various PIU-related interrupt requests (level 2) occur.

14.2.8 AIUINTREG (0x0B00 0084)

Bit	15	14	13	12	11	10	9	8
Name	Reserved	Reserved	Reserved	Reserved	Reserved	Reserved	INTMIDDLE	INTMST
R/W	R	R	R	R	R	R	R	R
RTCST	0	0	0	0	0	0	0	0
Other resets	0	0	0	0	0	0	0	0

Bit	7	6	5	4	3	2	1	0
Name	Reserved	Reserved	Reserved	Reserved	Reserved	Reserved	INTSIDLE	Reserved
R/W	R	R	R	R	R	R	R	R
RTCST	0	0	0	0	0	0	0	0
Other resets	0	0	0	0	0	0	0	0

Bit	Name	Function
15 to 10	Reserved	0 is returned when read
9	INTMIDDLE	Audio input (MIC) idle interrupt request (received data is lost). This interrupt request occurs if a valid data exists in MIDATREG register when data is received from A/D converter. 0 : Not occurred 1 : Occurred
8	INTMST	Audio input (MIC) receive completion interrupt request. This interrupt request occurs when a 10-bit converted data from the A/D converter is received. 0 : Not occurred 1 : Occurred
7 to 2	Reserved	0 is returned when read
1	INTSIDLE	Audio output (speaker) idle interrupt request (mute). This interrupt request occurs if there is no valid data in SODATREG register when data is transferred to D/A converter. 0 : Not occurred 1 : Occurred
0	Reserved	0 is returned when read

This register indicates when various AIU-related interrupt requests occur.

14.2.9 MPIUINTREG (0x0B00 008E)

Bit	15	14	13	12	11	10	9	8
Name	Reserved	Reserved	Reserved	Reserved	Reserved	Reserved	Reserved	Reserved
R/W	R	R	R	R	R	R	R	R
RTCRST	0	0	0	0	0	0	0	0
Other resets	0	0	0	0	0	0	0	0

Bit	7	6	5	4	3	2	1	0
Name	Reserved	PADCMD INTR	PADADP INTR	PADPAGE1 INTR	PADPAGE0 INTR	PADDLOST INTR	Reserved	PENCHG INTR
R/W	R	R/W	R/W	R/W	R/W	R/W	R	R/W
RTCRST	0	0	0	0	0	0	0	0
Other resets	0	0	0	0	0	0	0	0

Bit	Name	Function
15 to 7	Reserved	0 is returned when read
6	PADCMDINTR	Enables PIU command scan interrupt 0 : Disable 1 : Enable
5	PADADPINTR	Enables PIU AD Port Scan interrupt 0 : Disable 1 : Enable
4	PADPAGE1INTR	Enables PIU data buffer page 1 interrupt 0 : Disable 1 : Enable
3	PADPAGE0INTR	Enables PIU data buffer page 0 interrupt 0 : Disable 1 : Enable
2	PADDLOSTINTR	Enables A/D data timeout interrupt 0 : Disable 1 : Enable
1	Reserved	0 is returned when read
0	PENCHGINTR	Enables touch panel contact status change interrupt 0 : Disable 1 : Enable

This register is used to mask various PIU-related interrupts.

14.2.10 MAUIINTREG (0x0B00 0090)

Bit	15	14	13	12	11	10	9	8
Name	Reserved	Reserved	Reserved	Reserved	Reserved	Reserved	INTMIDDLE	INTMST
R/W	R	R	R	R	R/W	R/W	R/W	R/W
RTCST	0	0	0	0	0	0	0	0
Other resets	0	0	0	0	0	0	0	0

Bit	7	6	5	4	3	2	1	0
Name	Reserved	Reserved	Reserved	Reserved	Reserved	Reserved	INTSIDLE	Reserved
R/W	R	R	R	R	R/W	R/W	R/W	R
RTCST	0	0	0	0	0	0	0	0
Other resets	0	0	0	0	0	0	0	0

Bit	Name	Function
15 to 12	Reserved	0 is returned when read
11, 10	Reserved	Write 0 when write. 0 is returned when read.
9	INTMIDDLE	Enables audio input (MIC) idle interrupt (received data is lost) 0 : Disable 1 : Enable
8	INTMST	Enables audio input (MIC) receive complete interrupt 0 : Disable 1 : Enable
7 to 4	Reserved	0 is returned when read
3, 2	Reserved	Write 0 when write. 0 is returned when read.
1	INTSIDLE	Enables audio output (speaker) idle interrupt (mute) 0 : Disable 1 : Enable
0	Reserved	0 is returned when read

This register is used to mask various AIU-related interrupts.

14.2.11 MKIUINTREG (0x0B00 0092)

Bit	15	14	13	12	11	10	9	8
Name	Reserved	Reserved	Reserved	Reserved	Reserved	Reserved	Reserved	Reserved
R/W	R	R	R	R	R	R	R	R
RTCRST	0	0	0	0	0	0	0	0
Other resets	0	0	0	0	0	0	0	0

Bit	7	6	5	4	3	2	1	0
Name	Reserved	Reserved	Reserved	Reserved	Reserved	MSKKDAT LOST	MSKKDAT RDY	MSKK DOWNINT
R/W	R	R	R	R	R	R/W	R/W	R/W
RTCRST	0	0	0	0	0	0	0	0
Other resets	0	0	0	0	0	0	0	0

Bit	Name	Function
15 to 3	Reserved	0 is returned when read
2	MSKKDATLOST	Enables Keyboard Data Lost interrupt 0 : Disable 1 : Enable This bit may be used to temporarily mask the Keyboard Data Lost interrupt request. This bit does not effect Keyboard Data Lost event detection.
1	MSKKDATRDY	Enables Keyboard Data Ready interrupt 0 : Disable 1 : Enable This bit may be used to temporarily mask the Keyboard Data Ready interrupt request. This bit does not effect Keyboard Data Ready event detection.
0	MSKKDOWNINT	Enables Key Down interrupt 0 : Disable 1 : Enable This bit may be used to temporarily mask the Key Down interrupt request. This bit does not effect Key Down event detection.

14.2.12 KIUINTREG (0x0B00 0198)

Bit	15	14	13	12	11	10	9	8
Name	Reserved	Reserved	Reserved	Reserved	Reserved	Reserved	Reserved	Reserved
R/W	R	R	R	R	R	R	R	R
RTCST	0	0	0	0	0	0	0	0
Other resets	0	0	0	0	0	0	0	0

Bit	7	6	5	4	3	2	1	0
Name	Reserved	Reserved	Reserved	Reserved	Reserved	KDATLOST	KDATRDY	KDOWNINT
R/W	R	R	R	R	R	R/W	R/W	R/W
RTCST	0	0	0	0	0	0	0	0
Other resets	0	0	0	0	0	0	0	0

Bit	Name	Function
15 to 3	Reserved	0 is returned when read
2	MSKKDATLOST	Keyboard Data Lost interrupt request. This bit is set to 1 if the RETDAT0 register is updated prior to being read by the CPU. 0 : Not occurred 1 : Occurred This bit is cleared by writing 1.
1	MSKKDATRDY	Keyboard Data Ready interrupt request. This bit is set to 1 when the last enabled RETDAT register is updated. 0 : Not occurred 1 : Occurred This bit is cleared by writing 1.
0	MSKKDOWNINT	Key Down interrupt request. This bit is set to 1 when the scan sequencer is idle and any SCANIN input has been sampled low. 0 : Not occurred 1 : Occurred This bit is cleared by writing 1.

[MEMO]

CHAPTER 15 POWER MANAGEMENT UNIT (PMU)

This chapter describes the Power Management Unit (PMU) operation, register settings and power modes.

15.1 General

The PMU performs power management within the V_R4181 and controls the power supply throughout the system. The PMU provides the following functions:

- Reset control
- Shutdown control
- Power-on control
- Low-power mode control

15.2 Reset Control

The operations of the RTC, peripheral units, CPU core, and PMUINTREG register bit settings during a reset are listed below.

Table 15-1. Operations during Reset

Reset type	RTC	Peripheral units	CPU core	PMUINTREG bits
RTC reset	Reset	Reset	Cold Reset	RTCST = 1
RSTSW reset 1	Active	Reset	Cold Reset	RSTSW = 1 SDRAM = 0
RSTSW reset 2	Active	Active	Cold Reset	RSTSW = 1 SDRAM = 1

Caution When bit 6 of the PMUINTREG register is set to 1, only the CPU core is reset during a RSTSW reset cycle, and all internal peripheral units retain their current state. Software must re-initialize or reset all peripheral units in this case.

Bit 6 of the PMUINTREG register should be set to 1 only when SDRAM memory is used to preserve SDRAM data during a RSTSW reset.

15.2.1 RTC reset

When the RTCRST# signal becomes active, the PMU resets all internal peripheral units including the RTC unit. It also resets (Cold Reset) the CPU core.

In addition, the RTCRST bit in the PMUINTREG register is set to 1. After the CPU core is restarted, the RTCRST bit must be checked and cleared to 0 by software.

For details of the timing of RTC reset, refer to **CHAPTER 8 INITIALIZATION INTERFACE**.

15.2.2 RSTSW reset

When the RSTSW# signal becomes active, the PMU resets (Cold Reset) the CPU core. When bit 6 of the PMUINTREG register is cleared to 0, the PMU also resets all internal peripheral units.

In addition, the RSTSW bit in the PMUINTREG register is set to 1. After the CPU core is restarted, the RSTSW bit must be checked and cleared to 0 by software.

For details of the timing of RSTSW reset, refer to **CHAPTER 8 INITIALIZATION INTERFACE**.

15.2.3 Preserving DRAM data on RSTSW reset

(1) Preserving EDO-DRAM data

When an RSTSW reset takes place, the PMU activates the CAS#/RAS# pins to generate a CBR self refresh request to EDO DRAM.

Remark There is no burst CBR refresh before and after CBR self refresh by RSTSW reset.

Figure 15-1. EDO DRAM Signals on RSTSW Reset (SDRAM bit = 0)

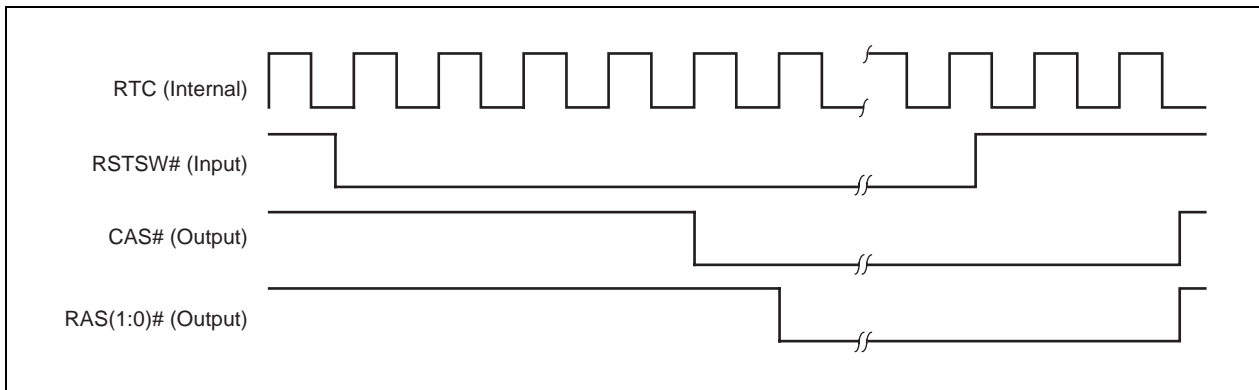

(2) Preserving SDRAM data

VR4181 does not perform any self refresh cycles on RSTSW reset when using SDRAM. When bit 6 of the PMUINTREG register is set to 1, the PMU does not reset the memory controller (MEMC). Therefore, the MEMC completes current SDRAM access and performs CBR refresh cycle on RSTSW reset. On the other hand, when bit 6 of the PMUINTREG register is set to 0, the MEMC is reset regardless of current cycle and does not perform CBR refresh cycle (SDRAM data will be destroyed).

15.3 Shutdown Control

The operations of the RTC, peripheral units, CPU core, and PMUINTREG register bit settings during a reset are listed below.

For detail of the timing of each shutdown, refer to **CHAPTER 8 INITIALIZATION INTERFACE**.

Table 15-2. Operations during Shutdown

Shutdown type	RTC	Peripheral units	CPU core	PMUINTREG bits
HALTimer shutdown	Active	Reset	Cold Reset	HALTIMERRST = 1
Deadman's SW shutdown	Active	Reset	Cold Reset	TIMOUTRST = 1
Hibernate shutdown	Active	Reset	Cold Reset	–
BATTINH shutdown	Active	Reset	Cold Reset	BATTINH = 1

15.3.1 HALTimer shutdown

After the CPU core is activated (following the mode change from Shutdown or Hibernate mode to Fullspeed mode), or the CPU core is reset by RSTSW reset, software must write 1 to HALTIMERRST bit in the PMUCNTRREG register within about four seconds to clear the HALTimer.

If the HALTimer is not reset within about four seconds after the CPU core is activated, the PMU resets all peripheral units except for RTC and PMU. Next, the PMU resets (Cold Reset) the CPU core.

In addition, TIMOUTRST bit in PMUINTREG register is set to 1. After the CPU core is restarted, TIMOUTRST bit must be checked and cleared to 0 by software.

15.3.2 Deadman's SW shutdown

When the Deadman's SW function is enabled, software must write 1 to DSWCLR bit in the DSUCLRREG register each time a Deadman's SW setting is made, to clear the Deadman's SW counter (for more information on the function of the DSU, refer to **CHAPTER 17 DEADMAN'S SWITCH UNIT (DSU)**).

If the Deadman's SW counter is not cleared during a Deadman's SW setting, the PMU resets all peripheral units except for RTC and PMU. Next, the PMU resets (Cold Reset) the CPU core.

In addition, DMSRST bit in the PMUINTREG register is set to 1. After the CPU core is restarted, DMSRST bit must be checked and cleared to 0 by software.

15.3.3 Software shutdown

When the HIBERNATE instruction is executed, the PMU checks for currently pending interrupt requests. If there are no pending interrupt requests, it stops the CPU clock. It then resets all peripheral units except for the RTC and the PMU.

The PMU register contents do not change.

15.3.4 BATTINH shutdown

If the BATTINH signal is asserted when the CPU core is going to be activated, the PMU stops CPU activation and resets all peripheral units except for the RTC and the PMU. Next, it resets the CPU core.

In addition, BATTINH bit in the PMUINTREG register is set to 1. After the CPU core is restarted, BATTINH bit must be checked and cleared to 0 by software.

For details of the timing of BATTINH shutdown, see **15.4 Power-on Control** below.

15.4 Power-on Control

The causes of CPU core activation (mode change from shutdown mode or Hibernate mode to Fullspeed mode) are called activation factors. There are twenty activation factors: a power switch interrupt (POWER), sixteen types of GPIO activation interrupts (GPIO(15:0)), a DCD interrupt (DCD#), a CompactFlash interrupt, and an elapsed timer interrupt.

Battery low detection (BATTINH/BATTINT# pin check) is a factor that prevents CPU core activation.

The period (power-on wait time), in which the POWERON pin is active at power-on, can be specified by using PMUWAITREG register. After RTCRST, by which the CPU core is initialized, the period is 343.75 ms. Power-on wait time can be specified when activation is caused by sources other than RTCRST.

When MPOWER signal is low level (Hibernate mode or during CPU core activation), to stop supplying voltage to the 2.5 V power-supply systems is recommended to reduce the leak current. This means that this power supply can become 0 V while the MPOWER signal is inactive. The following operation will not be affected by supplying voltage of 2.3 V or more to this power supply within the period from when the MPOWER signal becomes active to when PLL starts oscillation.

Caution When the CPU core moves to the Hibernate mode by executing the HIBERNATE instruction, if an activation factor occurs simultaneously, the CPU core may be activated without asserting the POWERON signal after the MPOWER signal is once de-asserted. Moreover, if RSTSW#, which is not an activation factor of the Hibernate mode, is asserted at the same time as the activation factor occurs, the CPU core may be activated without asserting the POWERON signal after the MPOWER signal is de-asserted once.

15.4.1 Activation via Power Switch interrupt request

When the POWER signal is asserted, the PMU asserts the POWERON signal and provides external notification that the CPU core is being activated. After asserting the POWERON signal, the PMU checks the BATTINH signal and then de-asserts the POWERON signal.

If the BATTINH signal is high level, the PMU cancels peripheral unit reset and starts the Cold Reset sequence to activate the CPU core.

If the BATTINH signal is low level, the PMU sets 1 to BATTINH bit in the PMUINTREG register and then performs another shutdown. After the CPU core is restarted, BATTINH bit must be checked and cleared to 0 by software.

Remark Activation via Power Switch interrupt request never sets POWERSWINTR bit in the PMUINTREG to 1.

Figure 15-2. Activation via Power Switch Interrupt Request (BATTINH = H)

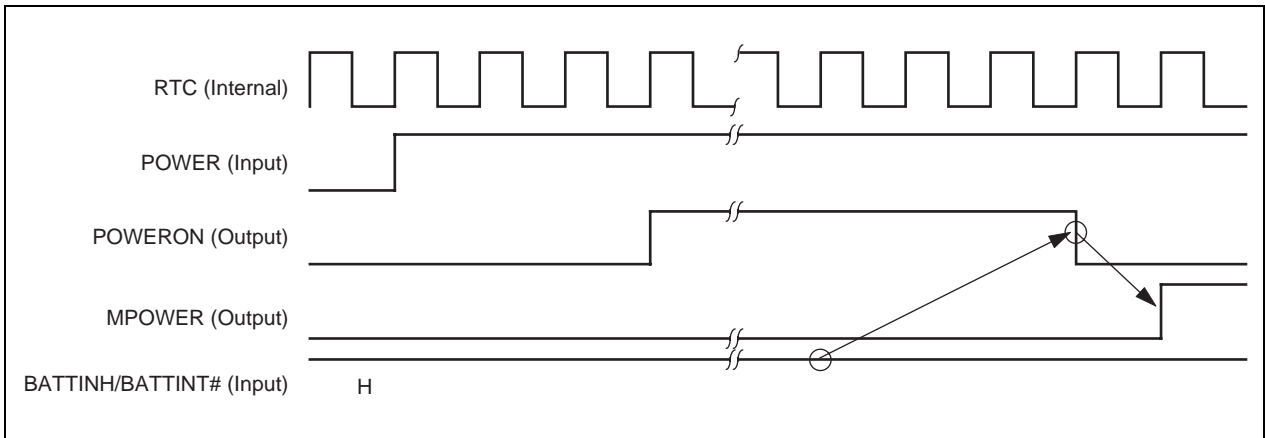
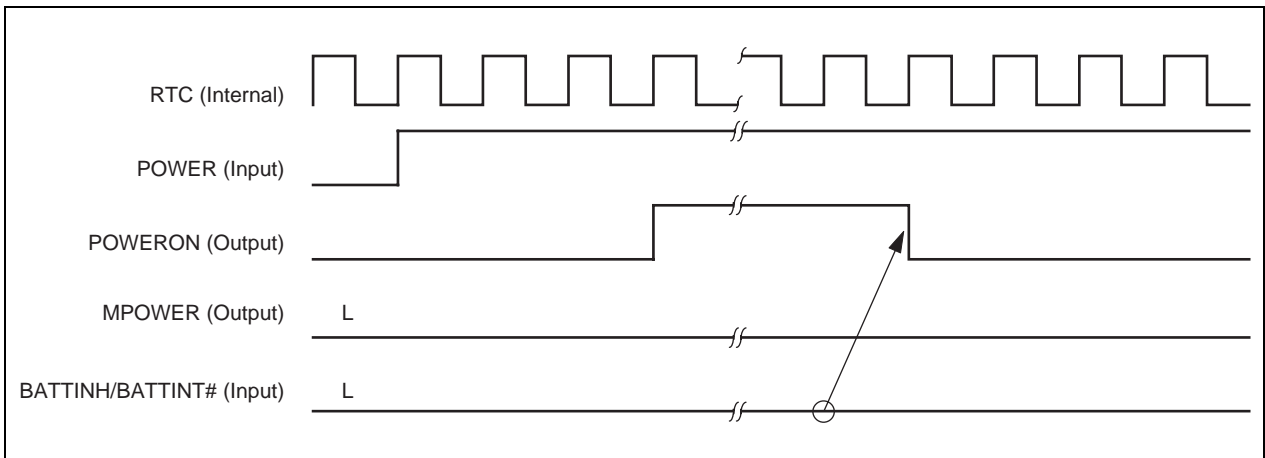

Figure 15-3. Activation via Power Switch Interrupt Request (BATTINH = L)



15.4.2 Activation via CompactFlash interrupt request

When the CF_INT signal is asserted, the PMU asserts the POWERON signal and provides external notification that the CPU core is being activated. After asserting the POWERON signal, the PMU checks the BATTINH signal and then de-asserts the POWERON signal.

If the BATTINH signal is high level, the PMU cancels peripheral unit reset and starts the Cold Reset sequence to activate the CPU core.

If the BATTINH signal is low level, the PMU sets 1 to BATTINH bit in the PMUINTREG register and then performs another shutdown. After the CPU core is restarted, BATTINH bit must be checked and cleared to 0 by software.

Figure 15-4. Activation via CompactFlash Interrupt Request (BATTINH = H)

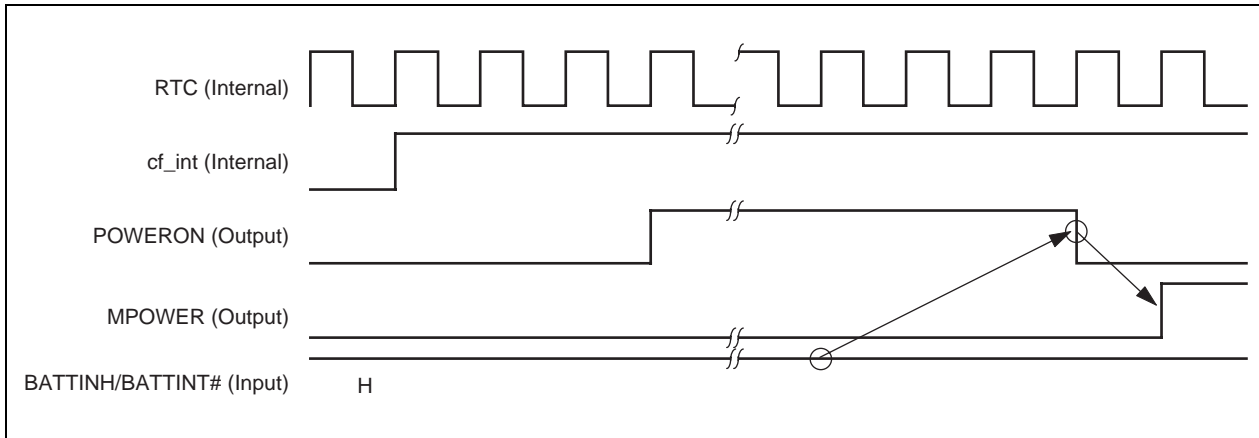
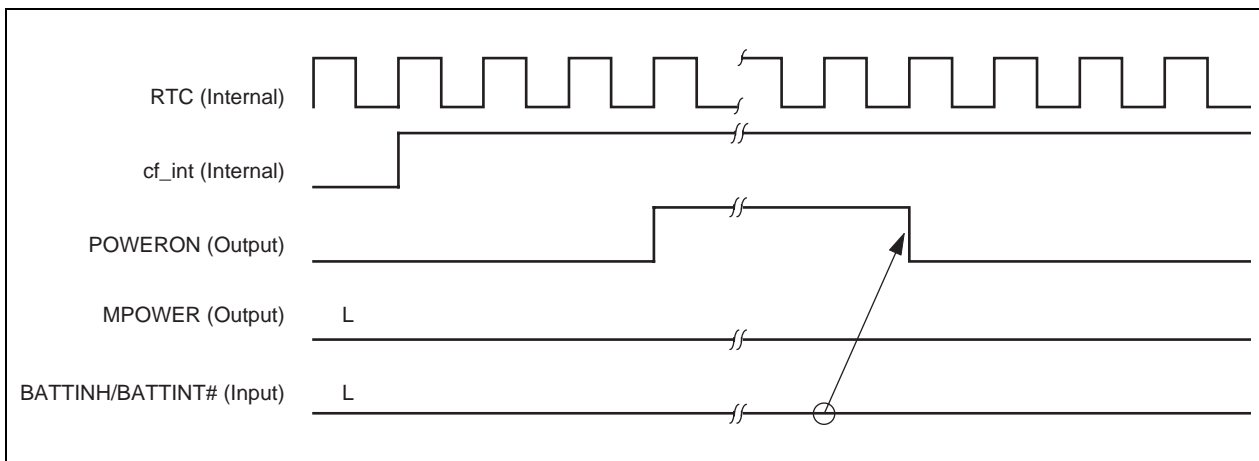

Figure 15-5. Activation via CompactFlash Interrupt Request (BATTINH = L)



15.4.3 Activation via GPIO Activation interrupt request

When any of the GPIO(15:0) signals are asserted, the PMU checks the GPIO(15:0) activation interrupt enable bits in the GIU. If GPIO(15:0) activation interrupts are enabled, the PMU asserts the POWERON signal and provides external notification that the CPU core is being activated (since the GPIO(15:0) activation enable interrupt bits are cleared after an RTC reset, the GPIO(15:0) signal cannot be used for activation immediately after an RTC reset).

The PMU asserts the POWERON signal, then checks the BATTINH signal and de-asserts the POWERON signal.

When the BATTINH signal is high level, the PMU cancels the peripheral unit reset and starts the Cold Reset sequence to activate the CPU core.

When the BATTINH signal is low level, the PMU sets 1 to BATTINH bit in the PMUINTREG register and then performs another shutdown. After the CPU core is restarted, the BATTINH bit must be checked and cleared to 0 by software.

The CPU sets 1 to the corresponding GPIOINTR bit in the PMUINTREG or PMUINT2REG regardless of whether activation succeeds or fails.

Caution The changes in the GPIO signal are ignored while POWERON signal is active.

Figure 15-6. Activation via GPIO Activation Interrupt (BATTINH = H)

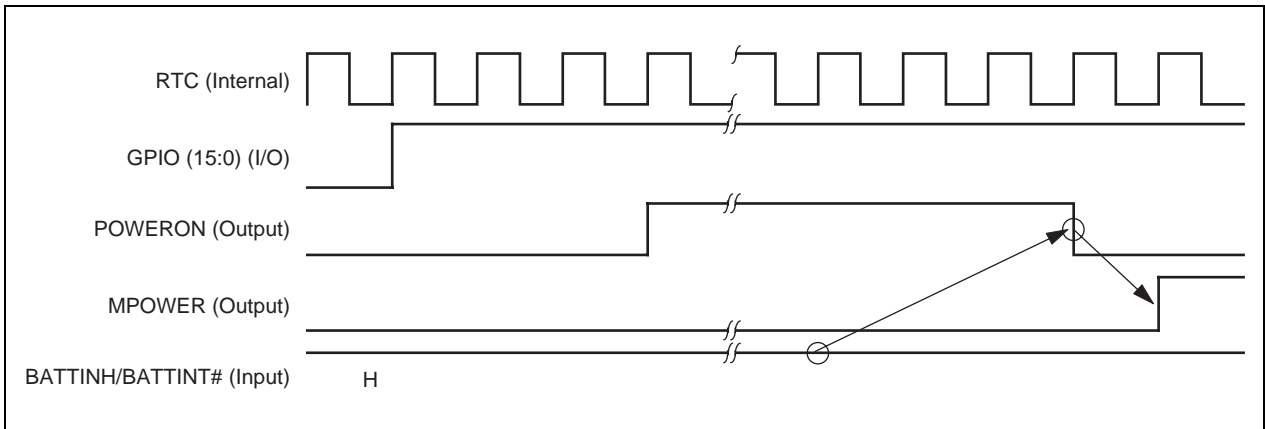
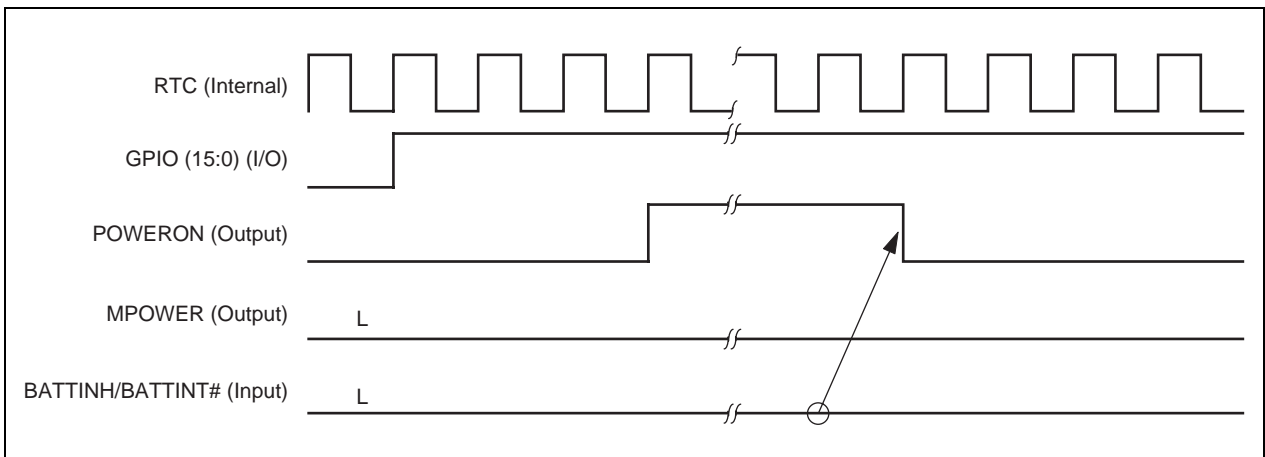

Figure 15-7. Activation via GPIO Activation Interrupt (BATTINH = L)



15.4.4 Activation via DCD Interrupt

When the DCD# signal is asserted, the PMU asserts the POWERON signal and provides external notification that the CPU core is being activated. After asserting the POWERON signal, the PMU checks the BATTINH signal and then de-asserts the POWERON signal.

If the BATTINH signal is high level, the PMU cancels the peripheral unit reset and starts the Cold Reset sequence to activate the CPU core.

If the BATTINH signal is low level, the PMU sets 1 to BATTINH bit in the PMUINTREG register and then performs another shutdown. After the CPU core is restarted, the BATTINH bit must be checked and cleared to 0 by software.

The DCDST bit in the PMUINTREG register does not indicate whether a DCD interrupt has occurred but instead reflects the current status of the DCD# pin.

Cautions

1. Once POWERSW has been asserted, the PMU cannot recognize changes in the DCD# signal. If the DCD# state when POWERSW is asserted is different from the DCD# state when POWERSW is de-asserted, the change in the DCD# signal is detected only after POWERSW is de-asserted. However, if the DCD# state when POWERSW is asserted is the same as the DCD# state when POWERSW is de-asserted, any changes in the DCD# signal that occur while POWERSW is asserted are not detected.

2. The changes in the DCD# signal are ignored while POWERON signal is active.
3. There is no indicator which shows DCD wake-up, if DCD# signal has already changed from active to inactive during power-on sequence. In other words, if software can not find wake-up cause and if DCDST bit indicates that DCD# signal is inactive, the above situation occurred.

Figure 15-8. Activation via DCD Interrupt (BATTINH = H)

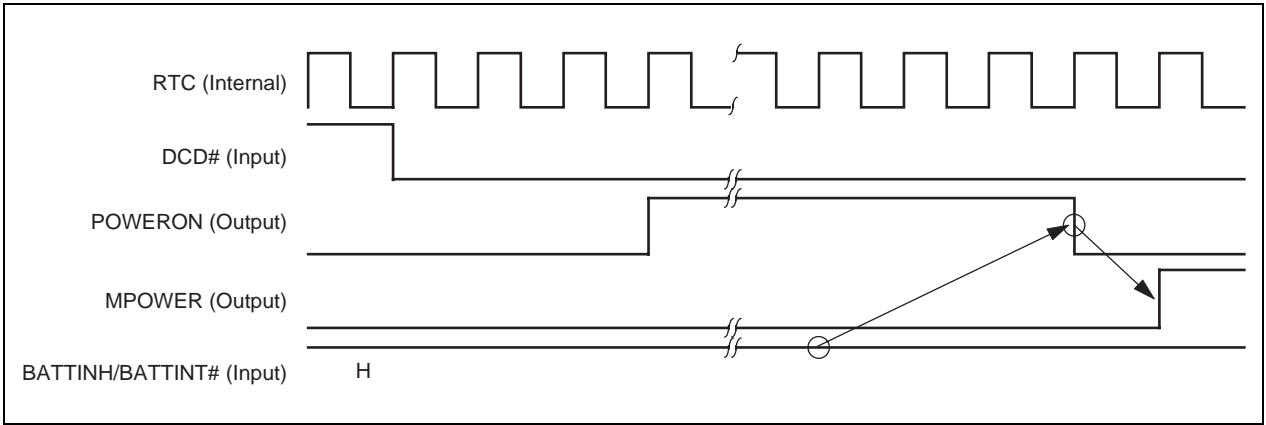
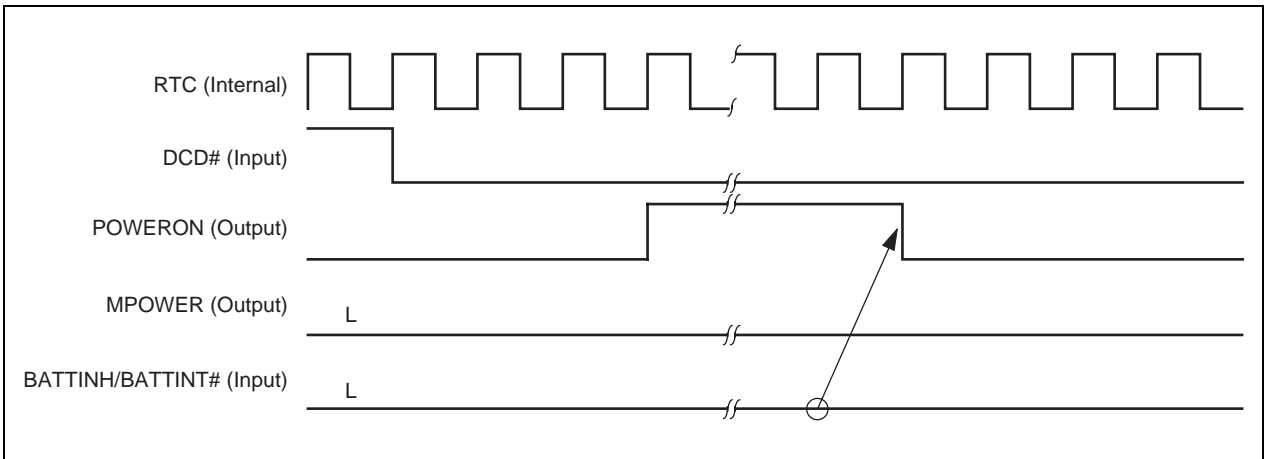

Figure 15-9. Activation via DCD Interrupt (BATTINH = L)



15.4.5 Activation via Elapsed Timer interrupt (alarm interrupt)

When the alarm interrupt (alarm_intr) signal generated from the elapsed timer is asserted, the PMU asserts the POWERON signal and provides external notification that the CPU core is being activated. After asserting the POWERON signal, the PMU checks the BATTINH signal and then de-asserts the POWERON signal.

If the BATTINH signal is high level, the PMU cancels the peripheral unit reset and starts the Cold Reset sequence to activate the CPU core.

If the BATTINH signal is low level, the PMU sets 1 to BATTINH bit in the PMUINTREG register and then performs another shutdown. After the CPU core is restarted, the BATTINH bit must be checked and cleared to 0 by software.

Caution The alarm interrupt is ignored while the POWERON signal is active. After the POWERON signal becomes inactive, the PMU is notified.

Figure 15-10. Activation via Alarm Interrupt (BATTINH = H)

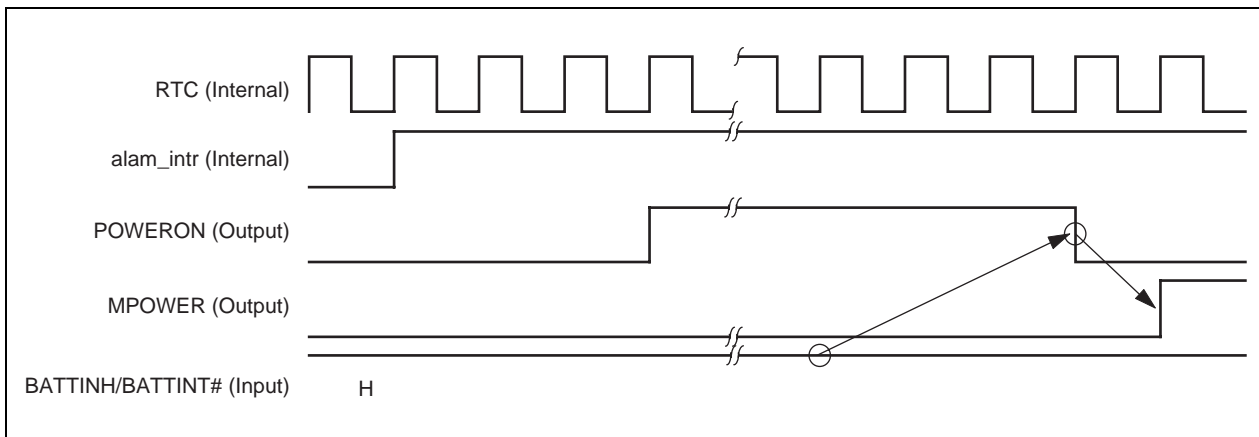
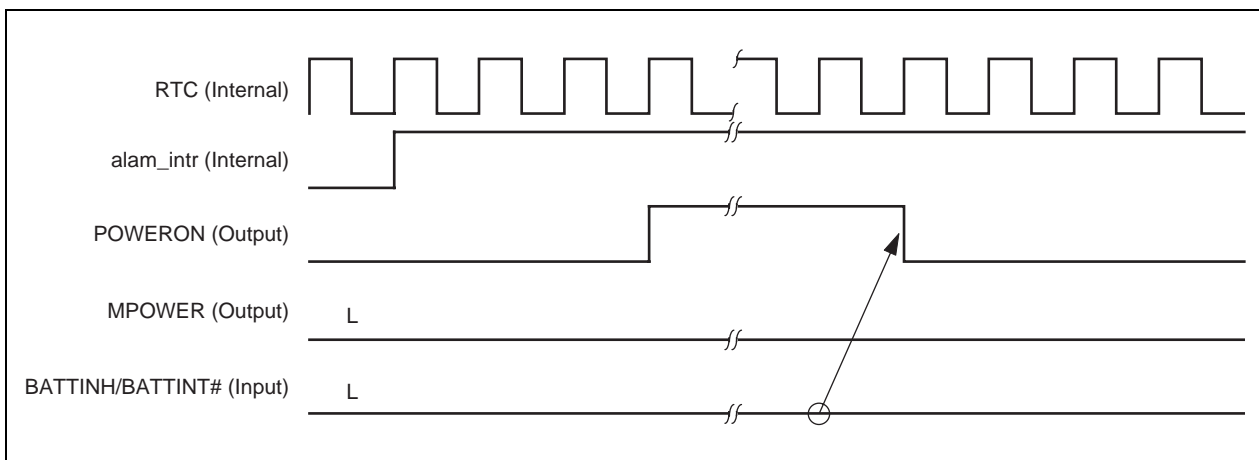

Figure 15-11. Activation via Alarm Interrupt (BATTINH = L)



15.5 DRAM Interface Control

The PMU provides a register to control the DRAM interface during Hibernate mode. The DRAMHIBCTL register permits software to directly control the state of the DRAM interface pins prior to executing a HIBERNATE instruction.

The DRAMHIBCTL register also provides status from the MEMC. The software flow when entering and exiting Hibernate mode is shown below.

15.5.1 System request to enter Hibernate mode (EDO DRAM)

- <1> Copy contents of all 2.5 V register ^{Note} that must be preserved during Hibernate mode into the battery backed general purpose registers, MISCREG(0:15), in the GIU (i.e. DRAM type and configuration, ROM type and configuration, etc.)

Note 3.3 V peripheral units (battery backed): PMU, GIU, LED, and RTC
 2.5 V peripheral units: all peripheral except PMU, GIU, LED, and RTC

- <2> Copy the codes for hibernation (<3> through <10> below) into the cache beginning at a 16-byte boundary, and jump to the cached codes.
- <3> Stop all peripheral clocks by writing zero to the CMUCLKMSK register.
- <4> If DRAM cannot accept mixed use of burst and distributive CBR refresh, set refresh count to every 250 ns, and execute CBR refresh cycles during $(0x3FFF \times \text{TClock period}) + \text{DRAM's self refresh specification}$.
- <5> Set refresh count to maximum in the BCURFCNTREG register to prevent a refresh cycle from interruption of the hibernation sequence.
- <6> Set SUSPEND bit in the DRAMHIBCTL register to 1 to request the MEMC to perform a burst refresh cycle if enabled, and then put the DRAM into self refresh mode.
- <7> Poll OK_STOP_CLK bit in the DRAMHIBCTL register to 1 to request the MEMC to perform a burst refresh cycle and then put the DRAM into self refresh mode.
- <8> Set DRAM_EN bit in the DRAMHIBCTL register to 1 so that the DRAM interface signals are latched and held in a self refresh configuration (Now the V_{R4181} is ready to enter Hibernate mode).
- <9> Set STOP_CLK bit in the DRAMHIBCTL register to 1 to request that TClock for MEMC stops.
- <10> Execute a HIBERNATE instruction.

15.5.2 System request to enter Hibernate mode (SDRAM)

- <1> Copy contents of all 2.5 V register ^{Note} that must be preserved during Hibernate mode into the battery backed general purpose registers, MISCREG(0:15), in the GIU (i.e. DRAM type and configuration, ROM type and configuration, etc.).

Note 3.3 V peripheral units (battery backed): PMU, GIU, LED, and RTC
 2.5 V peripheral units: all peripheral except PMU, GIU, LED, and RTC

- <2> Copy the codes for hibernation (<3> through <10> below) into the cache beginning at a 16-byte boundary, and jump to the cached codes.
- <3> Stop all peripheral clocks by writing zero to the CMUCLKMSK register.
- <4> Set refresh count to maximum in the BCURFCNTREG register to prevent a refresh cycle from interruption of the hibernation sequence.
- <5> Set SUSPEND bit in the DRAMHIBCTL register to 1 to request the MEMC to perform a burst refresh cycle and then put the DRAM into self refresh mode.
- <6> Poll OK_STOP_CLK bit in the DRAMHIBCTL register to 1 to request the MEMC to perform a burst refresh cycle and then put the DRAM into self refresh mode.
- <7> Set DRAM_EN bit in the DRAMHIBCTL register to 1 so that the DRAM interface signals are latched and held in a self-refresh configuration.
- <8> Clear SUSPEND bit in the DRAMHIBCTL register to 0.
- <9> Set STOP_CLK bit in the DRAMHIBCTL register to 1 to request that TClock stops.
- <10> Execute a HIBERNATE instruction.

15.5.3 Wake-up from Hibernate mode (EDO DRAM)

- <1> A wake-up event occurs such as a transition on the POWER pin, a DCD interrupt, etc. which causes the PMU to start a power-on sequence.
- <2> Power is applied to the external system of 3.3 V logic and the Vr4181 of 2.5 V logic. The PMU waits until the external 3.3 V and the 2.5 V power supply are stable, and then negates reset to the internal Vr4110 CPU and Vr4181 logic.
- <3> Software execution resumes at the reset vector. At the same time, the MEMC begins a burst refresh cycle if enabled, since SUSPEND bit in the DRAMHIBCTL register is still set to 1. Such refresh cycles are not indicated on the DRAM interface pins since these pins are being driven with the latched self refresh configuration when Hibernate mode was entered.
- <4> Copy the codes for waking up (<5> through <13> below) into the cache beginning at a 16-byte boundary, and jump to the cached codes.
- <5> Software begins polling OK_STOP_CLK bit in the DRAMHIBCTL register to determine when the MEMC has completed the burst refresh and entered self-refresh mode.
- <6> Software should check and clear TIMOUTRST bit in the PMUINTREG register in the case a HALTimer Shutdown had occurred.
- <7> Reinitialize all the registers and peripherals during Hibernate mode and restore those registers saved in the battery backed general purpose registers, MISKREG(0:15), in the GIU.

Remark Software must wait until the MEMC completes the burst refresh and enters self-refresh mode before reinitializing the MEMC registers. Otherwise unpredictable behavior of MEMC could result.

- <8> Clear DRAM_EN bit in the DRAMHIBCTL register to 0 so that the DRAM interface signals are again driven directly by the MEMC.
- <9> Clear SUSPEND bit to 0, which causes the MEMC to exit self-refresh mode and begin a burst refresh cycle.
- <10> Poll OK_USE_MEM bit to determine when the burst refresh cycle has completed.
- <11> When OK_USE_MEM bit is set 1, the burst has completed.
- <12> Set refresh count to every 250 ns, and execute CBR refresh cycles during $(0x3FFF \times \text{TClock period}) + \text{DRAM self refresh specification}$.
- <13> Restore desired refresh rate to the BCURFCNTREG register, and then return to uncached segment.
- <14> Software exits the wake-up sequence and returns control to the system.

15.5.4 Wake-up from Hibernate mode (SDRAM)

- <1> A wake-up event occurs such as a transition on the POWER pin, a DCD interrupt, etc. which causes the PMU to start a power-on sequence.
- <2> Power is applied to the external system of 3.3 V logic and the V_{R4181} of 2.5 V logic. The PMU waits until the external 3.3 V and the 2.5 V power supply are stable, and then negates reset to the internal V_{R4110} CPU and V_{R4181} logic.
- <3> Software execution resumes at the reset vector.
- <4> Software should check and clear TIMOUTRST bit in the PMUINTREG in the case that a HALTimer Shutdown had occurred.
- <5> Copy codes for waking up (<6> through <10> below) into the cache beginning at a 16-byte boundary, and jump to the cached codes.
- <6> Reinitialize all the registers and peripherals reset during Hibernate mode and restore those registers saved in the battery backed general purpose registers, MISKREG(0:15), in the GIU.
- <7> Clear DRAM_EN bit in the DRAMHIBCTL register to 0 so that the DRAM interface signals are again driven directly by the MEMC.
- <8> Set the BCURFCNTREG register to a value that will generate a refresh request every 1 μs .
- <9> Wait until at least $0x3FFF \times \text{TClock period}$. This sequence is for burst refresh after self refresh.
- <10> Restore desired refresh rate to the BCURFCNTREG register, and then return to uncached segment.
- <11> Exit the wake-up sequence and return control to the system.

15.5.5 Suspend mode

In entering and exiting Suspend mode, skip the DRAM_EN bit in the DRAMHIBCTL register settings; otherwise, the control of DRAMHIBCTL register is essentially the same as that of Hibernate mode.

15.6 Register Set

The PMU registers are listed below:

Table 15-3. PMU Registers

Address	R/W	Register symbol	Function
0x0B00 00A0	R/W	PMUINTREG	PMU status register
0x0B00 00A2	R/W	PMUCNTREG	PMU control register
0x0B00 00A8	R/W	PMUWAITREG	PMU wait counter register
0x0B00 00AC	R/W	PMUDIVREG	PMU divide mode register
0x0B00 00B2	R/W	DRAMHIBCTL(4:0)	DRAM Hibernate control register

15.6.1 PMUINTREG (0x0B00 00A0)

(1/2)

Bit	15	14	13	12	11	10	9	8
Name	Reserved	Reserved	Reserved	GP WAKEUP	CF_INT	DCDST	RTCINTR	BATTINH
R/W	R	R	R	R/W	R/W	R	R/W	R/W
RTCRST	0	0	0	0	0	0	0	0
Other resets	0	0	0	0	0	0	0	0

Bit	7	6	5	4	3	2	1	0
Name	Reserved	SDRAM	TIMOUT RST	RTCRST	RSTSW	DMSRST	BATTINTR	POWER SWINTR
R/W	R/W	R/W	R/W	R/W	R/W	R/W	R/W	R/W
RTCRST	0	0	0	0	0	0	0	0
Other resets	0	0	0	0	0	0	0	0

Bit	Name	Function
15 to 13	Reserved	0 is returned when read
12	GPWAKEUP	GPIO interrupt request detection. Cleared to 0 when 1 is written. 1 : Detected 0 : Not detected This bit must be checked and cleared to 0 after the CPU core is restarted.
11	CF_INT	CF_INT interrupt request detection. Cleared to 0 when 1 is written. 1 : Detected 0 : Not detected This bit must be checked and cleared to 0 after the CPU core is restarted.
10	DCDST	DCD# pin state 1 : High level (inactive) 0 : Low level (active)
9	RTCINTR	RTC alarm interrupt request detection. Cleared to 0 when 1 is written. 1 : Detected 0 : Not detected This bit must be checked and cleared to 0 after the CPU core is restarted.
8	BATTINH	Battery low detection during activation. Cleared to 0 when 1 is written. 1 : Detected 0 : Not detected This bit must be checked and cleared to 0 after the CPU core is restarted.
7	Reserved	Write 0 when write. 0 is returned when read.
6	SDRAM	This bit determines whether the internal peripheral units are reset by RSTSW. This bit must be clear to 0 when EDO-DRAM is used. 1 : Reset (SDRAM data lost during RSTSW) 0 : Not reset (SDRAM data preserved during RSTSW)

Bit	Name	Function
5	TIMOUTRST	HALTimer reset request detection. Cleared to 0 when 1 is written. 1 : Detected 0 : Not detected This bit must be checked and cleared to 0 after the CPU core is restarted.
4	RTCST	RTC reset detection. Cleared to 0 when 1 is written. 1 : Detected 0 : Not detected This bit must be checked and cleared to 0 after the CPU core is restarted.
3	RSTSW	Reset Switch (RSTSW) interrupt request detection. Cleared to 0 when 1 is written. 1 : Detected 0 : Not detected This bit must be checked and cleared to 0 after the CPU core is restarted.
2	DMSRST	Deadman's Switch interrupt request detection. Cleared to 0 when 1 is written. 1 : Detected 0 : Not detected This bit must be checked and cleared to 0 after the CPU core is restarted.
1	BATTINTR	Battery low detection during normal operation. Cleared to 0 when 1 is written. 1 : Detected 0 : Not detected This bit must be checked and cleared to 0 after the CPU core is restarted.
0	POWERSWINTR	Power Switch interrupt request detection. Cleared to 0 when 1 is written. 1 : Detected 0 : Not detected This bit must be checked and cleared to 0 after the CPU core is restarted.

This register indicates that whether power-on factor or reset signal is detected.

It also indicates the status of the DCD# pin.

The BATTINTR bit is set to 1 when the BATTINH/BATTINT# signal becomes low and a battery-low interrupt request occurs in modes other than the Hibernate mode (MPOWER = H).

The POWERSWINTR bit is set to 1 when the POWER signal becomes high and a Power Switch interrupt request occurs in modes other than the Hibernate mode. However, this bit is not set to 1 when the POWER signal becomes high in the Hibernate mode (MPOWER = L).

15.6.2 PMUCNTREG (0x0B00 00A2)

(1/2)

Bit	15	14	13	12	11	10	9	8
Name	Reserved	Reserved	Reserved	Reserved	Reserved	Reserved	Reserved	Reserved
R/W	R	R	R	R	R	R	R	R
RTCST	0	0	0	0	0	0	0	0
Other resets	0	0	0	0	0	0	0	0

Bit	7	6	5	4	3	2	1	0
Name	STANDBY	Reserved	Selfrfresh	Suspend	Hibernate	HALTIMER RST	Reserved	Reserved
R/W	R/W	R/W	R	R	R	R/W	R	R/W
RTCST	0	0	0	0	0	0	0	0
Other resets	0	0	0	0	0	0	0	0

Bit	Name	Function
15 to 8	Reserved	0 is returned when read
7	STANDBY	Standby mode setting. This setting is performed only for software, and does not affect hardware in any way. 1 : Standby mode 0 : Normal mode
6	Reserved	Write 0 when write. 0 is returned when read.
5	Selfrfresh	Self refresh status 1 : Completed 0 : Not ready
4	Suspend	Suspend mode status (always 0 at Fullspeed mode) 1 : Suspend mode 0 : Not suspend mode
3	Hibernate	Hibernate mode status (always 0 at Fullspeed mode) 1 : Hibernate mode 0 : Not hibernate mode

(2/2)

Bit	Name	Function
2	HALTIMERRST	HALTimer reset 1 : Reset 0 : Set This bit is cleared to 0 automatically after reset of the HALTimer ^{Note1, 2}
1	Reserved	0 is returned when read
0	Reserved	Write 0 when write. 0 is returned when read.

Notes1. When HALTIMERRST bit is cleared to 0 just after set to 1, the HALTimer may not be reset. Wait more than 6 RTC clock cycles from writing 1 to writing 0.

2. Verify that HALTIMERRST bit is 0 before reset HALTimer. When this bit is 1, HALTimer is not reset even if write 1 to this bit. In this case, write 0 to this bit first, then write 1 after more than 6 RTC clock cycles.

This register is used to set CPU shutdown and overall system management operations.

The HALTIMERRST bit must be reset within about four seconds after activation. Resetting of the HALTIMERRST bit indicates that the VR4181 itself has been activated normally. If the HALTIMERRST bit is not reset within about four seconds after activation, program execution is regarded as abnormal (possibly due to a runaway) and an automatic shutdown is performed.

15.6.3 PMUWAITREG (0x0B00 00A8)

Bit	15	14	13	12	11	10	9	8
Name	Reserved	Reserved	WCOUNT 13	WCOUNT 12	WCOUNT 11	WCOUNT 10	WCOUNT 9	WCOUNT 8
R/W	R	R	R/W	R/W	R/W	R/W	R/W	R/W
RTCST	0	0	1	0	1	1	0	0
Other resets	0	0	Note	Note	Note	Note	Note	Note

Bit	7	6	5	4	3	2	1	0
Name	WCOUNT 7	WCOUNT 6	WCOUNT 5	WCOUNT 4	WCOUNT 3	WCOUNT 2	WCOUNT 1	WCOUNT 0
R/W	R/W	R/W	R/W	R/W	R/W	R/W	R/W	R/W
RTCST	0	0	0	0	0	0	0	0
Other resets	Note	Note	Note	Note	Note	Note	Note	Note

Bit	Name	Function
15, 14	Reserved	0 is returned when read
13 to 0	WCOUNT(13:0)	Activation wait time timer count value Activation wait time = WCOUNT(13:0) x (1/32.768) ms

Note Hold the value before reset

This register is used to set the activation wait time when the CPU is activated.

This register is set to 0x2C00 (it sets 343.75 ms activation wait time) after RTC reset. Therefore, the 343.75 ms wait time is always inserted as an activation wait time, when the CPU is activated immediately after RTC reset. The activation wait time can be changed by setting this register for the CPU activation from the Hibernate mode.

When this register is set to 0x0, 0x1, 0x2, 0x3, or 0x4, the operation is not guaranteed. Software must set the value of this register to 0x4 or greater to assure reliable operation.

15.6.4 PMUDIVREG (0x0B00 00AC)

Bit	15	14	13	12	11	10	9	8
Name	Reserved	Reserved	Reserved	Reserved	Reserved	Reserved	Reserved	Reserved
R/W	R	R	R	R	R	R	R	R
RTCRST	0	0	0	0	0	0	0	0
Other resets	0	0	0	0	0	0	0	0

Bit	7	6	5	4	3	2	1	0
Name	Reserved	Reserved	Reserved	Reserved	Reserved	DIV2	DIV1	DIV0
R/W	R	R	R	R	R	R/W	R/W	R/W
RTCRST	0	0	0	0	0	0	0	0
Other resets	0	0	0	0	0	Note	Note	Note

Bit	Name	Function
15 to 3	Reserved	0 is returned when read
2 to 0	DIV(2:0)	Divide mode 111 : RFU 110 : RFU 101 : RFU 100 : DIV4 mode 011 : DIV3 mode 010 : DIV2 mode 001 : DIV1 mode 000 : Default divide-mode setting (DIV2)

Note Hold the value before reset

This register is used to set CPU core's divide mode. The divide mode setting determines the division rate of the TClock in relation to the pipeline clock (PClock) frequency.

Since the contents of this register are cleared to 0 during an RTC reset, the divide mode setting always DIV2 mode just after RTC reset.

Though the divide mode has been set via this register, the setting does not become effective immediately in the processor's operations. In order to change divided mode, software has to execute a HIBERNATE instruction. The divided mode will change when the CPU core wakes up from Hibernate mode.

15.6.5 DRAMHIBCTL (0x0B00 00B2)

Bit	15	14	13	12	11	10	9	8
Name	Reserved	Reserved	Reserved	Reserved	Reserved	Reserved	Reserved	Reserved
R/W	R	R	R	R	R	R	R	R
RTCST	0	0	0	0	0	0	0	0
Other resets	0	0	0	0	0	0	0	0

Bit	7	6	5	4	3	2	1	0
Name	Reserved	Reserved	Reserved	OK_USE_MEM	OK_STOP_CLK	STOP_CLK	SUSPEND	DRAM_EN
R/W	R	R	R	R	R	R/W	R/W	R/W
RTCST	0	0	0	0	0	0	0	0
Other resets	0	0	0	Note	Note	Note	Note	Note

Bit	Name	Function
15 to 5	Reserved	0 is returned when read
4	OK_USE_MEM	OK to use memory 1 : Ready 0 : Not ready
3	OK_STOP_CLK	OK to stop clocks 1 : Ready (DRAM is in self refresh mode) 0 : Not ready (MEMC is busy to do burst refresh)
2	STOP_CLK	Run/stop clocks for MEMC 1 : Stop 0 : Run
1	SUSPEND	Self refresh request. This bit is for software request to MEMC to perform burst refresh and enter self refresh mode 1 : Request 0 : No request
0	DRAM_EN	DRAM interface operation enable 1 : Disabled (Hibernate mode) 0 : Enabled (normal mode)

Note Hold the value before reset

15.7 V_R4181 Power Mode

This section describes the V_R4181 power modes in detail. The V_R4181 supports the following four power modes:

- Fullspeed mode
- Standby mode
- Suspend mode
- Hibernate mode

15.7.1 Power mode and state transition

The V_R4181 transits from Fullspeed mode to Standby mode, Suspend mode, or Hibernate mode by executing a STANBY, SUSPEND, or HIBERNATE instruction respectively. RTCRST is always valid in every mode, and initializes (resets) units in the V_R4181 including the RTC. However, the V_R4181 does not restart by RTCRST.

The figure on the following page, Figure 15-12, is a conceptual diagram showing the interaction and control of the four power modes of the V_R4181.

Figure 15-12. Transition of Vr4181 Operating Mode (Power Mode)

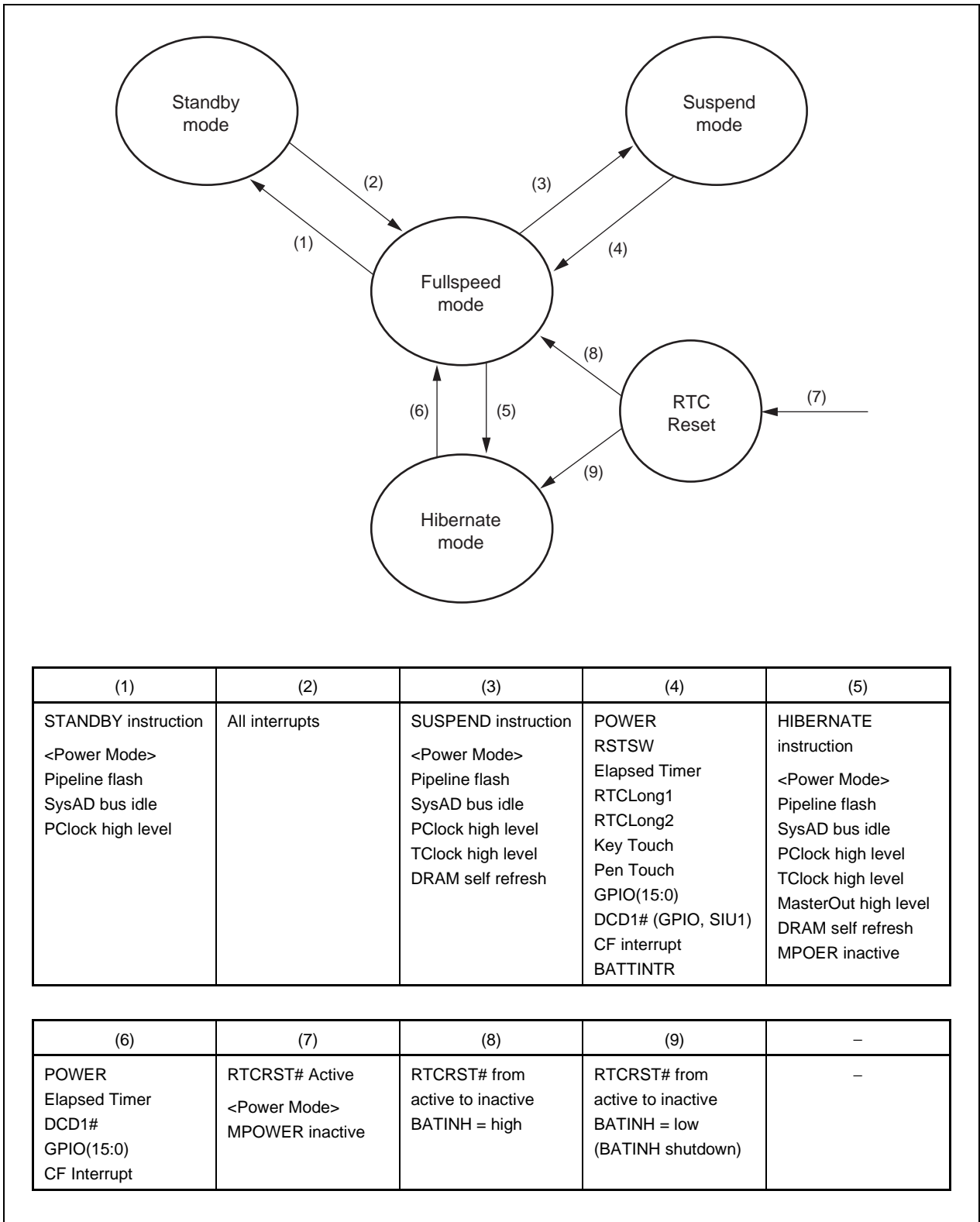

Table 15-4 shows power mode overview and transaction:

Table 15-4. Overview of Power Mode

Mode	Internal peripheral unit					CPU core
	RTC	ICU	DMA	LCDC	Other	
Fullspeed	On	On	On	On	Selectable	On
Standby	On	On	On	On	Selectable	Off
Suspend	On	On	Off	Off	Off	Off
Hibernate	On	Off	Off	Off	Off	Off
Off	Off	Off	Off	Off	Off	Off

(1) Fullspeed mode

All internal clocks and bus clocks operate. The V_R4181 can perform every function in the Fullspeed mode.

(2) Standby mode

All internal clocks except for clocks within the internal peripheral units and timer/interrupt unit in the CPU core are fixed to high level.

To transit from Fullspeed mode to Standby mode, execute the STANDBY instruction. After the STANDBY instruction passed the WB stage, the V_R4181 waits until SysAD bus (internal) enters idle state. Then, internal clocks shut down, and pipeline operation stops. PLL, timer/interrupt clock, internal bus clock (Tclock and MasterOut), and RTC continue their operation.

(3) Suspend mode

All internal clocks are fixed to high level, except for internal clocks within all internal peripheral units other than RTC and PMU and clocks within all units other than timer/interrupt unit.

To transition from Fullspeed mode to Suspend mode, execute the SUSPEND instruction. After the SUSPEND instruction passed the WB stage, DRAM enters self refresh mode, and the MPOWER pin becomes inactive, the V_R4181 waits until SysAD bus (internal) enters idle state. Then, internal clocks are shut down, and pipeline operation stops. PLL, timer/interrupt clock, MasterOut, and RTC continue their operation.

Software must first disable the internal LCD controller and power-down LCD panel, and place the DRAM into self refresh mode before executing the SUSPEND instruction.

(4) Hibernate mode

All clocks within the CPU core and clocks within all internal peripheral units other than RTC and PMU are fixed to high level.

To switch to Hibernate mode from Fullspeed mode, first execute the hibernate sequence (refer to **15.5 DRAM Interface Control**). After executing the HIBERNATE instruction, V_R4181 waits until the SysAD bus (internal) enters idle state after the completion of the WB stage of the HIBERNATE instruction, and the MPOWER pin has been made inactive. Then the internal clocks are shut down, and the pipeline stops. PLL also stops, but the RTC continues to operate.

CHAPTER 16 REALTIME CLOCK UNIT (RTC)

This chapter describes the RTC unit's operations and register settings.

16.1 General

The RTC unit has a total of three timers, including the following two types.

- RTCLong.....This is a 24-bit programmable counter that counts down using 32.768 kHz frequency. Cycle interrupts occur for up to 512 seconds. The RTC unit includes two RTCLong timers.
- ElapsedTimeThis is a 48-bit up counter that counts up using 32.768 kHz frequency. It counts up to 272 years before returning to zero. It includes 48-bit comparator (ECMPHREG, ECMPREG, and ECMPMREG) and 48-bit alarm time register (ETIMELREG, ETIMEMREG, and ETIMEHREG) to enable interrupts to occur at specified times.

16.2 Register Set

The RTC registers are listed below.

Table 16-1. RTC Registers

Address	R/W	Register symbol	Function
0x0B00 00C0	R/W	ETIMELREG	Elapsed Time L register
0x0B00 00C2	R/W	ETIMEMREG	Elapsed Time M register
0x0B00 00C4	R/W	ETIMEHREG	Elapsed Time H register
0x0B00 00C8	R/W	ECMPLREG	Elapsed compare L register
0x0B00 00CA	R/W	ECMPMREG	Elapsed compare M register
0x0B00 00CC	R/W	ECMPHREG	Elapsed compare H register
0x0B00 00D0	R/W	RTCL1LREG	RTC Long 1 L register
0x0B00 00D2	R/W	RTCL1HREG	RTC Long 1 H register
0x0B00 00D4	R	RTCL1CNTLREG	RTC Long 1 count L register
0x0B00 00D6	R	RTCL1CNTHREG	RTC Long 1 count H register
0x0B00 00D8	R/W	RTCL2LREG	RTC Long 2 L register
0x0B00 00DA	R/W	RTCL2HREG	RTC Long 2 H register
0x0B00 00DC	R	RTCL2CNTLREG	RTC Long 2 count L register
0x0B00 00DE	R	RTCL2CNTHREG	RTC Long 2 count H register
0x0B00 01DE	R/W	RTCINTREG	RTC interrupt register

Each register is described in detail below.

16.2.1 Elapsed Time registers

(1) ETIMELREG (0x0B00 00C0)

Bit	15	14	13	12	11	10	9	8
Name	ETIME15	ETIME14	ETIME13	ETIME12	ETIME11	ETIME10	ETIME9	ETIME8
R/W	R/W	R/W	R/W	R/W	R/W	R/W	R/W	R/W
RTCRST	0	0	0	0	0	0	0	0
Other resets	Note	Note	Note	Note	Note	Note	Note	Note

Bit	7	6	5	4	3	2	1	0
Name	ETIME7	ETIME6	ETIME5	ETIME4	ETIME3	ETIME2	ETIME1	ETIME0
R/W	R/W	R/W	R/W	R/W	R/W	R/W	R/W	R/W
RTCRST	0	0	0	0	0	0	0	0
Other resets	Note	Note	Note	Note	Note	Note	Note	Note

Bit	Name	Function
15 to 0	ETIME(15:0)	ElapsedTime bit 15 to 0

Note Continues counting.

(2) ETIMEMREG (0x0B00 00C2)

Bit	15	14	13	12	11	10	9	8
Name	ETIME31	ETIME30	ETIME29	ETIME28	ETIME27	ETIME26	ETIME25	ETIME24
R/W	R/W	R/W	R/W	R/W	R/W	R/W	R/W	R/W
RTCRST	0	0	0	0	0	0	0	0
Other resets	Note	Note	Note	Note	Note	Note	Note	Note

Bit	7	6	5	4	3	2	1	0
Name	ETIME23	ETIME22	ETIME21	ETIME20	ETIME19	ETIME18	ETIME17	ETIME16
R/W	R/W	R/W	R/W	R/W	R/W	R/W	R/W	R/W
RTCRST	0	0	0	0	0	0	0	0
Other resets	Note	Note	Note	Note	Note	Note	Note	Note

Bit	Name	Function
15 to 0	ETIME(31:16)	ElapsedTime bit 31 to 16

Note Continues counting.

(3) ETIMEHREG (0x0B00 00C4)

Bit	15	14	13	12	11	10	9	8
Name	ETIME47	ETIME46	ETIME45	ETIME44	ETIME43	ETIME42	ETIME41	ETIME40
R/W	R/W	R/W	R/W	R/W	R/W	R/W	R/W	R/W
RTCRST	0	0	0	0	0	0	0	0
Other resets	Note	Note	Note	Note	Note	Note	Note	Note

Bit	7	6	5	4	3	2	1	0
Name	ETIME39	ETIME38	ETIME37	ETIME36	ETIME35	ETIME34	ETIME33	ETIME32
R/W	R/W	R/W	R/W	R/W	R/W	R/W	R/W	R/W
RTCRST	0	0	0	0	0	0	0	0
Other resets	Note	Note	Note	Note	Note	Note	Note	Note

Bit	Name	Function
15 to 0	ETIME(47:32)	ElapsedTime bit 47 to 32

Note Continues counting

These registers indicate the elapsed timer's value. They count up using a 32.768 kHz frequency and when a match occurs with the elapsed compare registers, an alarm (elapsed time interrupt) occurs (and the count-up continues). A write operation is valid once values have been written to all registers (ETIMELREG, ETIMEMREG, and ETIMEHREG).

These registers have no buffers for read. Therefore, an illegal data may be read if the counter value changes during a read operation. When using a read data, be sure to read a value twice and check that two read values are the same.

When setting these registers again, wait until at least 100 μ s (\cong 32.768 kHz clock \times 3) have elapsed before doing so.

16.2.2 Elapsed Time compare registers

(1) ECMPPLREG (0x0B00 00C8)

Bit	15	14	13	12	11	10	9	8
Name	ECMP15	ECMP14	ECMP13	ECMP12	ECMP11	ECMP10	ECMP9	ECMP8
R/W	R/W	R/W	R/W	R/W	R/W	R/W	R/W	R/W
RTCRST	0	0	0	0	0	0	0	0
Other resets	Note	Note	Note	Note	Note	Note	Note	Note

Bit	7	6	5	4	3	2	1	0
Name	ECMP7	ECMP6	ECMP5	ECMP4	ECMP3	ECMP2	ECMP1	ECMP0
R/W	R/W	R/W	R/W	R/W	R/W	R/W	R/W	R/W
RTCRST	0	0	0	0	0	0	0	0
Other resets	Note	Note	Note	Note	Note	Note	Note	Note

Bit	Name	Function
15 to 0	ECMP(15:0)	Value to be compared with ElapsedTime bit 15 to 0

Note Previous value is retained.

(2) ECMPMREG (0x0B00 00CA)

Bit	15	14	13	12	11	10	9	8
Name	ECMP31	ECMP30	ECMP29	ECMP28	ECMP27	ECMP26	ECMP25	ECMP24
R/W	R/W	R/W	R/W	R/W	R/W	R/W	R/W	R/W
RTCRST	0	0	0	0	0	0	0	0
Other resets	Note	Note	Note	Note	Note	Note	Note	Note

Bit	7	6	5	4	3	2	1	0
Name	ECMP23	ECMP22	ECMP21	ECMP20	ECMP19	ECMP18	ECMP17	ECMP16
R/W	R/W	R/W	R/W	R/W	R/W	R/W	R/W	R/W
RTCRST	0	0	0	0	0	0	0	0
Other resets	Note	Note	Note	Note	Note	Note	Note	Note

Bit	Name	Function
15 to 0	ECMP(31:16)	Value to be compared with ElapsedTime bit 31 to 16

Note Previous value is retained.

(3) ECMPHREG (0x0B00 00CC)

Bit	15	14	13	12	11	10	9	8
Name	ECMP47	ECMP46	ECMP45	ECMP44	ECMP43	ECMP42	ECMP41	ECMP40
R/W	R/W	R/W	R/W	R/W	R/W	R/W	R/W	R/W
RTCRST	0	0	0	0	0	0	0	0
Other resets	Note	Note	Note	Note	Note	Note	Note	Note

Bit	7	6	5	4	3	2	1	0
Name	ECMP39	ECMP38	ECMP37	ECMP36	ECMP35	ECMP34	ECMP33	ECMP32
R/W	R/W	R/W	R/W	R/W	R/W	R/W	R/W	R/W
RTCRST	0	0	0	0	0	0	0	0
Other resets	Note	Note	Note	Note	Note	Note	Note	Note

Bit	Name	Function
15 to 0	ECMP(47:32)	Value to be compared with ElapsedTime bit 47 to 32

Note Previous value is retained.

Use these registers to set the values to be compared with values in the elapsed time registers.

A write operation is valid once values have been written to all registers (ECMPLREG, ECMPMREG, and ECMPHREG).

When setting these registers again, wait until at least 100 μ s (\cong 32.768 kHz clock \times 3) have elapsed before doing so.

16.2.3 RTC Long 1 registers

(1) RTCL1LREG (0x0B00 00D0)

Bit	15	14	13	12	11	10	9	8
Name	RTCL1P15	RTCL1P14	RTCL1P13	RTCL1P12	RTCL1P11	RTCL1P10	RTCL1P9	RTCL1P8
R/W	R/W	R/W	R/W	R/W	R/W	R/W	R/W	R/W
RTCRST	0	0	0	0	0	0	0	0
Other resets	Note	Note	Note	Note	Note	Note	Note	Note

Bit	7	6	5	4	3	2	1	0
Name	RTCL1P7	RTCL1P6	RTCL1P5	RTCL1P4	RTCL1P3	RTCL1P2	RTCL1P1	RTCL1P0
R/W	R/W	R/W	R/W	R/W	R/W	R/W	R/W	R/W
RTCRST	0	0	0	0	0	0	0	0
Other resets	Note	Note	Note	Note	Note	Note	Note	Note

Bit	Name	Function
15 to 0	RTCL1P(15:0)	Bit 15 to 0 for RTCLong1 counter cycle

Note Previous value is retained.

(2) RTCL1HREG (0x0B00 00D2)

Bit	15	14	13	12	11	10	9	8
Name	Reserved	Reserved	Reserved	Reserved	Reserved	Reserved	Reserved	Reserved
R/W	R	R	R	R	R	R	R	R
RTCRST	0	0	0	0	0	0	0	0
Other resets	Note	Note	Note	Note	Note	Note	Note	Note

Bit	7	6	5	4	3	2	1	0
Name	RTCL1P23	RTCL1P22	RTCL1P21	RTCL1P20	RTCL1P19	RTCL1P18	RTCL1P17	RTCL1P16
R/W	R/W	R/W	R/W	R/W	R/W	R/W	R/W	R/W
RTCRST	0	0	0	0	0	0	0	0
Other resets	Note	Note	Note	Note	Note	Note	Note	Note

Bit	Name	Function
15 to 8	Reserved	0 is returned when read
7 to 0	RTCL1P(23:16)	Bit 23 to 16 for RTCLong1 counter cycle

Note Previous value is retained.

Use these registers to set the RTCLong1 counter cycle. The RTCLong1 counter begins its countdown at the value written to these registers.

A write operation is valid once values have been written to both registers (RTCL1LREG and RTCL1HREG).

When setting these registers again, wait until at least 100 μ s (\cong 32.768 kHz clock \times 3) have elapsed before doing so.

Cautions 1. The RTC unit is stopped when all zeros are written.

2. Any combined setting of “RTCL1HREG = 0x0000” and “RTCL1LREG = 0x0001, 0x0002, 0x0003, 0x0004” is prohibited.

16.2.4 RTC Long 1 Count registers

(1) RTCL1CNTLREG (0x0B00 00D4)

Bit	15	14	13	12	11	10	9	8
Name	RTCL1C15	RTCL1C14	RTCL1C13	RTCL1C12	RTCL1C11	RTCL1C10	RTCL1C9	RTCL1C8
R/W	R	R	R	R	R	R	R	R
RTCRST	0	0	0	0	0	0	0	0
Other resets	Note	Note	Note	Note	Note	Note	Note	Note

Bit	7	6	5	4	3	2	1	0
Name	RTCL1C7	RTCL1C6	RTCL1C5	RTCL1C4	RTCL1C3	RTCL1C2	RTCL1C1	RTCL1C0
R/W	R	R	R	R	R	R	R	R
RTCRST	0	0	0	0	0	0	0	0
Other resets	Note	Note	Note	Note	Note	Note	Note	Note

Bit	Name	Function
15 to 0	RTCL1C(15:0)	RTCLong1 counter bit 15 to 0

Note Continues counting.

(2) RTCL1CNTHREG (0x0B00 00D6)

Bit	15	14	13	12	11	10	9	8
Name	Reserved	Reserved	Reserved	Reserved	Reserved	Reserved	Reserved	Reserved
R/W	R	R	R	R	R	R	R	R
RTCRST	0	0	0	0	0	0	0	0
Other resets	Note	Note	Note	Note	Note	Note	Note	Note

Bit	7	6	5	4	3	2	1	0
Name	RTCL1C23	RTCL1C22	RTCL1C21	RTCL1C20	RTCL1C19	RTCL1C18	RTCL1C17	RTCL1C16
R/W	R	R	R	R	R	R	R	R
RTCRST	0	0	0	0	0	0	0	0
Other resets	Note	Note	Note	Note	Note	Note	Note	Note

Bit	Name	Function
15 to 8	Reserved	0 is returned when read
7 to 0	RTCL1C(23:16)	RTCLong1 counter bit 23 to 16

Note Continues counting.

These registers indicate the RTCLong1 counter's values. The countdown uses a 32.768-kHz frequency and begins at the value set to the RTCLong1 registers. An RTCLong1 interrupt occurs when the counter reaches 0x00 0001 (at which point the counter returns to the start value and continues counting).

These registers have no buffers for read. Therefore, an illegal data may be read if the counter value changes during a read operation. When using a read data, be sure to read a value twice and check that two read vales are the same.

When setting these registers again, wait until at least 100 μ s (\cong 32.768 kHz clock \times 3) have elapsed before doing so.

16.2.5 RTC Long 2 registers

(1) RTCL2LREG (0x0B00 00D8)

Bit	15	14	13	12	11	10	9	8
Name	RTCL2P15	RTCL2P14	RTCL2P13	RTCL2P12	RTCL2P11	RTCL2P10	RTCL2P9	RTCL2P8
R/W	R/W	R/W	R/W	R/W	R/W	R/W	R/W	R/W
RTCRST	0	0	0	0	0	0	0	0
Other resets	Note	Note	Note	Note	Note	Note	Note	Note

Bit	7	6	5	4	3	2	1	0
Name	RTCL2P7	RTCL2P6	RTCL2P5	RTCL2P4	RTCL2P3	RTCL2P2	RTCL2P1	RTCL2P0
R/W	R/W	R/W	R/W	R/W	R/W	R/W	R/W	R/W
RTCRST	0	0	0	0	0	0	0	0
Other resets	Note	Note	Note	Note	Note	Note	Note	Note

Bit	Name	Function
15 to 0	RTCL2P(15:0)	Bit 15 to 0 for RTCLong2 counter cycle

Note Previous value is retained.

(2) RTCL2HREG (0x0B00 00DA)

Bit	15	14	13	12	11	10	9	8
Name	Reserved	Reserved	Reserved	Reserved	Reserved	Reserved	Reserved	Reserved
R/W	R	R	R	R	R	R	R	R
RTCRST	0	0	0	0	0	0	0	0
Other resets	Note	Note	Note	Note	Note	Note	Note	Note

Bit	7	6	5	4	3	2	1	0
Name	RTCL2P23	RTCL2P22	RTCL2P21	RTCL2P20	RTCL2P19	RTCL2P18	RTCL2P17	RTCL2P16
R/W	R/W	R/W	R/W	R/W	R/W	R/W	R/W	R/W
RTCRST	0	0	0	0	0	0	0	0
Other resets	Note	Note	Note	Note	Note	Note	Note	Note

Bit	Name	Function
15 to 8	Reserved	0 is returned when read
7 to 0	RTCL2P(23:16)	Bit 23 to 16 for RTCLong2 counter cycle

Note Previous value is retained.

Use these registers to set the RTCLong2 counter cycle. The RTCLong2 counter begins its countdown at the value written to these registers.

A write operation is valid once values have been written to both registers (RTCL2LREG and RTCL2HREG).

When setting these registers again, wait until at least $100 \mu\text{s}$ ($\cong 32.768 \text{ kHz clock} \times 3$) have elapsed before doing so.

Cautions 1. The RTC unit is stopped when all zeros are written.

2. Any combined setting of “RTCL2HREG = 0x0000” and “RTCL2LREG = 0x0001, 0x0002, 0x0003, 0x0004” is prohibited.

16.2.6 RTC Long 2 Count registers

(1) RTCL2CNTLREG (0x0B00 00DC)

Bit	15	14	13	12	11	10	9	8
Name	RTCL2C15	RTCL2C14	RTCL2C13	RTCL2C12	RTCL2C11	RTCL2C10	RTCL2C9	RTCL2C8
R/W	R	R	R	R	R	R	R	R
RTCRST	0	0	0	0	0	0	0	0
Other resets	Note	Note	Note	Note	Note	Note	Note	Note

Bit	7	6	5	4	3	2	1	0
Name	RTCL2C7	RTCL2C6	RTCL2C5	RTCL2C4	RTCL2C3	RTCL2C2	RTCL2C1	RTCL2C0
R/W	R	R	R	R	R	R	R	R
RTCRST	0	0	0	0	0	0	0	0
Other resets	Note	Note	Note	Note	Note	Note	Note	Note

Bit	Name	Function
15 to 0	RTCL2C(15:0)	RTCLong2 counter bit 15 to 0

Note Continues counting.

(2) RTCL2CNTHREG (0x0B00 00DE)

Bit	15	14	13	12	11	10	9	8
Name	Reserved	Reserved	Reserved	Reserved	Reserved	Reserved	Reserved	Reserved
R/W	R	R	R	R	R	R	R	R
RTCRST	0	0	0	0	0	0	0	0
Other resets	Note	Note	Note	Note	Note	Note	Note	Note

Bit	7	6	5	4	3	2	1	0
Name	RTCL2C23	RTCL2C22	RTCL2C21	RTCL2C20	RTCL2C19	RTCL2C18	RTCL2C17	RTCL2C16
R/W	R	R	R	R	R	R	R	R
RTCRST	0	0	0	0	0	0	0	0
Other resets	Note	Note	Note	Note	Note	Note	Note	Note

Bit	Name	Function
15 to 8	Reserved	0 is returned when read
7 to 0	RTCL2C(23:16)	RTCLong2 counter bit 23 to 16

Note Continues counting.

These registers indicate the RTCLong2 counter's values. The countdown uses a 32.768-kHz frequency and begins at the value set to the RTCLong2 registers. An RTCLong2 interrupt occurs when the counter reaches 0x00 0001 (at which point the counter returns to the start value and continues counting).

These registers have no buffers for read. Therefore, an illegal data may be read if the counter value changes during a read operation. When using a read data, be sure to read a value twice and check that two read vales are the same.

16.2.7 RTC interrupt register

(1) RTCINTREG (0x0B00 01DE)

Bit	15	14	13	12	11	10	9	8
Name	Reserved	Reserved	Reserved	Reserved	Reserved	Reserved	Reserved	Reserved
R/W	R	R	R	R	R	R	R	R
RTCRST	0	0	0	0	0	0	0	0
Other resets	0	0	0	0	0	0	0	0

Bit	7	6	5	4	3	2	1	0
Name	Reserved	Reserved	Reserved	Reserved	Reserved	RTCINTR2	RTCINTR1	RTCINTR0
R/W	R	R	R	R	R	R/W	R/W	R/W
RTCRST	0	0	0	0	0	0	0	0
Other resets	0	0	0	0	0	Note	Note	Note

Bit	Name	Function
15 to 3	Reserved	0 is returned when read
2	RTCINTR2	RTCLong2 interrupt. Cleared to 0 when 1 is written. 1 : Occurred 0 : Normal
1	RTCINTR1	RTCLong1 interrupt. Cleared to 0 when 1 is written. 1 : Occurred 0 : Normal
0	RTCINTR0	Status bit for elapsed time interrupt. Cleared to 0 when 1 is written. 1 : Occurred 0 : Normal

Note Previous value is retained.

This register is used to set/indicate the occurrences of interrupt requests of RTC.

[MEMO]

CHAPTER 17 DEADMAN'S SWITCH UNIT (DSU)

This chapter describes the DSU (Deadman's Switch Unit)'s operations and register settings.

17.1 General

The DSU detects when the VR4181 is in runaway (endless loop) state and resets the VR4181 to minimize runaway time. The use of the DSU to minimize runaway time effectively minimizes data loss that can occur due to software-related runaway states.

17.2 Register Set

The DSU registers are listed below.

Table 17-1. DSU Registers

Address	R/W	Register symbol	Function
0x0B00 00E0	R/W	DSUCNTREG	DSU control register
0x0B00 00E2	R/W	DSUSETREG	DSU dead time set register
0x0B00 00E4	W	DSUCLRREG	DSU clear register
0x0B00 00E6	R/W	DSUTIMREG	DSU elapsed time register

Each register is described in detail below.

17.2.1 DSUCNTREG (0x0B00 00E0)

Bit	15	14	13	12	11	10	9	8
Name	Reserved	Reserved	Reserved	Reserved	Reserved	Reserved	Reserved	Reserved
R/W	R	R	R	R	R	R	R	R
RTCRST	0	0	0	0	0	0	0	0
Other resets	0	0	0	0	0	0	0	0

Bit	7	6	5	4	3	2	1	0
Name	Reserved	Reserved	Reserved	Reserved	Reserved	Reserved	Reserved	DSWEN
R/W	R	R	R	R	R	R	R	R/W
RTCRST	0	0	0	0	0	0	0	0
Other resets	0	0	0	0	0	0	0	0

Bit	Name	Function
15 to 1	Reserved	0 is returned when read
0	DSWEN	Deadman's Switch function enable 1 : Enabled 0 : Disabled

This register is used to enable use of the Deadman's Switch functions.

17.2.2 DSUSETREG (0x0B00 00E2)

Bit	15	14	13	12	11	10	9	8
Name	Reserved	Reserved	Reserved	Reserved	Reserved	Reserved	Reserved	Reserved
R/W	R	R	R	R	R	R	R	R
RTCRST	0	0	0	0	0	0	0	0
Other resets	0	0	0	0	0	0	0	0

Bit	7	6	5	4	3	2	1	0
Name	Reserved	Reserved	Reserved	Reserved	DEDTIME3	DEDTIME2	DEDTIME1	DEDTIME0
R/W	R	R	R	R	R/W	R/W	R/W	R/W
RTCRST	0	0	0	0	0	0	0	1
Other resets	0	0	0	0	0	0	0	1

Bit	Name	Function
15 to 4	Reserved	0 is returned when read
3 to 0	DEDTIME(3:0)	Deadman's Switch cycle setting 1111 : 15 sec 1110 : 14 sec : 0010 : 2 sec 0001 : 1 sec 0000 : Setting prohibited

This register sets the cycle for Deadman's Switch functions.

The Deadman's Switch cycle can be set in 1-second increments in a range from 1 to 15 seconds. However, the VR4181's operation is undefined when 0x0 has been set to DEDTIME(3:0). The DSWCLR bit in the DSUCLRREG register must be set by means of software within the specified cycle time.

17.2.3 DSUCLRREG (0x0B00 00E4)

Bit	15	14	13	12	11	10	9	8
Name	Reserved	Reserved	Reserved	Reserved	Reserved	Reserved	Reserved	Reserved
R/W	R	R	R	R	R	R	R	R
RTCRST	0	0	0	0	0	0	0	0
Other resets	0	0	0	0	0	0	0	0

Bit	7	6	5	4	3	2	1	0
Name	Reserved	Reserved	Reserved	Reserved	Reserved	Reserved	Reserved	DSWCLR
R/W	R	R	R	R	R	R	R	W
RTCRST	0	0	0	0	0	0	0	0
Other resets	0	0	0	0	0	0	0	0

Bit	Name	Function
15 to 1	Reserved	0 is returned when read
0	DSWCLR	Deadman's Switch counter clear 1 : Clear 0 : Timer counting

This register clears the Deadman's Switch counter by setting the DSWCLR bit in this register to 1.

The Vr4181 automatically shuts down if 1 is not written to this register within the period specified in the DSUSETREG register.

In order to start next count, the DSWCLR bit in this register must be cleared to 0.

17.2.4 DSUTIMREG (0x0B00 00E6)

Bit	15	14	13	12	11	10	9	8
Name	Reserved	Reserved	Reserved	Reserved	Reserved	Reserved	Reserved	Reserved
R/W	R	R	R	R	R	R	R	R
RTCRST	0	0	0	0	0	0	0	0
Other resets	0	0	0	0	0	0	0	0

Bit	7	6	5	4	3	2	1	0
Name	Reserved	Reserved	Reserved	Reserved	CRTTIME3	CRTTIME2	CRTTIME1	CRTTIME0
R/W	R	R	R	R	R/W	R/W	R/W	R/W
RTCRST	0	0	0	0	0	0	0	0
Other resets	0	0	0	0	0	0	0	0

Bit	Name	Function
15 to 4	Reserved	0 is returned when read
3 to 0	CRTTIME(3:0)	Current Deadman's Switch timer value (elapsed time) 1111 : 15 sec 1110 : 14 sec : 0010 : 2 sec 0001 : 1 sec 0000 : Setting prohibited

This register indicates the elapsed time for the current Deadman's Switch timer.

17.3 Register Setting Flow

The DSU register setting flow is described below.

<1> Set the DSU's count-up value (from 1 to 15 seconds).

The CPU will be reset if the timer is not cleared (1 is not written to DSUCLRREG) within this time period.

DSUDTMREG address : 0x0B00 00E2 data : 0x000x

<2> Enable the DSU

DSUCNTREG address : 0x0B00 00E0 data : 0x0001

<3> Clear the timer within the time period specified in step 1 above. Set the timer to start another counting.

DSUCLRREG address : 0x0B00 00E4 data : 0x0001 (counter clear)

DSUCLRREG address : 0x0B00 00E4 data : 0x0000 (next count start)

For normal use, repeat step 3. To obtain the current elapsed time:

DSITIMREG address : 0x0B00 00E6 read (4 bits)

<4> Disable the DSU for DOZE mode or a shutdown.

DSUCNTREG address : 0x0B00 00E0 data : 0x0000

CHAPTER 18 GENERAL PURPOSE I/O UNIT (GIU)

18.1 Overview

18.1.1 GPIO pins and alternate functions

The VR4181 provides 32 general-purpose I/O divided into two groups of 16 pins each. The first group, GPIO(15:0) pins, are capable of supporting the following types of functions:

- Clocked serial interface (CSI)
- Secondary RS-232-C interface
- Color LCD interface (upper 4-bit data) or CompactFlash Card Detect inputs
- General-purpose outputs
- Interrupt/wake-up inputs
- Programmable chip selects
- External ISA system clock output

As Interrupt/wake-up inputs, any of GPIO(15:0) pins can be used.

The assignment of interface signals to particular GPIO pins is shown in the following table:

Table 18-1. Signal Assignment of GPIO(15:0) Pins

GPIO pin	Alternate signal 1	Alternate signal 2	Definition
GPIO15	FPD7	CD2#	Color LCD data bit output or Card Detect 2 input
GPIO14	FPD6	CD1#	Color LCD data bit output or Card Detect 1 input
GPIO13	FPD5	–	Color LCD data bit output
GPIO12	FPD4	–	Color LCD data bit output
GPIO11	PCS1#	–	Programmable chip select 1 output.
GPIO10	FRM	SYSCLK	CSI FRM input or SYSCLK output
GPIO9	CTS2#	–	Secondary RS-232-C CTS input
GPIO8	DSR2#	–	Secondary RS-232-C DSR input
GPIO7	DTR2#	–	Secondary RS-232-C DTR output
GPIO6	RTS2#	–	Secondary RS-232-C RTS output
GPIO5	DCD2#	–	Secondary RS-232-C DCD input
GPIO4	–	–	–
GPIO3	PCS0#	–	Programmable chip select 0 output.
GPIO2	SCK	–	CSI serial clock input
GPIO1	SO	–	CSI serial data output
GPIO0	SI	–	CSI serial data input

The second group, GPIO(31:16) pins, are capable of supporting the following types of functions:

- External ISA I/O interface
- External 16-bit bus-sizing signal
- ROM chip select
- Primary RS-232-C interface
- General-purpose input
- General-purpose output

Remark GPIO(31:16) pins can not be used as interrupt / wake-up input.

The assignment of interface signals to particular GPIO pins is shown in the following table:

Table 18-2. Signal Assignment of GPIO(31:16) Pins

GPIO pin	Alternate signal 1	Alternate signal 2	Definition
GPIO31	DSR1#	–	Primary RS-232-C DSR input
GPIO30	DTR1#	–	Primary RS-232-C DTR output
GPIO29	DCD1#	–	Primary RS-232-C DCD input
GPIO28	CTS1#	–	Primary RS-232-C CTS input
GPIO27	RTS1#	–	Primary RS-232-C RTS output
GPIO26	TxD1	–	Primary RS-232-C TxD output
GPIO25	RxD1	–	Primary RS-232-C RxD input
GPIO24	ROMCS2#	–	ROM chip select for bank 0
GPIO23	ROMCS1#	–	ROM chip select for bank 1
GPIO22	ROMCS0#	–	ROM chip select for bank 2
GPIO21	RESET#	–	External ISA reset
GPIO20 ^{Note}	UBE#	M	External ISA upper byte enable or LCD modulation output
GPIO19	IOCS16#	–	External ISA I/O chip select 16
GPIO18	IORDY	–	External ISA I/O channel ready
GPIO17	IOWR#	–	External ISA I/O write strobe
GPIO16	IORD#	–	External ISA I/O read strobe

Note This signal supports input only.

The GPIO29/DCD1# pin can cause the system to wake-up from a low power mode if enabled by software. The other pins listed above are only capable of providing general-purpose input or output, or the optional function listed.

18.1.2 Pin direction control

For each GPIO pin, the GIU provides one buffer enable, GPENn, one output data, GPOn, and one input data, GPIIn. The function of each GPIO pin is decoded by 2 register bits in one of the GPIO Mode registers. The most significant bit, GPnMD1, controls the direction of the GPIO pin while the system is powered (Fullspeed, Standby, and Suspend modes). When this bit is set to 1, the GPIO pin is normally configured as an output.

During Hibernate mode, the GPIO buffer enables are controlled by the GPHIBSTH and GPHIBSTL registers.

Remark n = 0 to 31

18.1.3 Non-volatile registers

The GIU includes sixteen 16-bit general-purpose battery-backed registers. These registers can be used by system software to save the state of selected registers located in the 2.5V core prior to entering Hibernate mode. Once a wake-up event occurs, system software can then restore the state of those 2.5V registers from the general-purpose battery-backed registers.

The battery-backed registers are located in the address range of 0x0B00 0330 to 0x0B00 034F.

18.2 Alternate Functions Overview

18.2.1 Clocked serial interface (CSI)

The clocked serial interface is enabled by writing to the GPIO Mode registers and utilizes the following GPIO pins:

Table 18-3. CSI Interface Signals

GPIO pin	CSI signal	Type
GPIO2	SCK	Input
GPIO1	SO	Output
GPIO0	SI	Input
GPIO10	FRM	Input

The GPIO10/FRM pin provides a multifunction control input option. In one mode, FRM determines data direction (transmit or receive). In the other mode, FRM inhibits transmission until sampled low. This mode is set in bit 15, FRMEN, of the CSIMODE register (address: 0x0B00 0900) (see **CHAPTER 13 CLOCKED SERIAL INTERFACE UNIT (CSI)**).

18.2.2 Primary and secondary serial (RS-232-C) interface

The GIU also provides pin mapping for the primary and secondary serial interfaces (RS-232-C, equivalent to 16550 UART).

The primary serial interface is enabled by writing to the GPIO Mode registers. It utilizes the following GPIO pins:

Table 18-4. Primary Serial Interface Signals

GPIO pin	Primary serial interface signal	Type
GPIO26	TxD1	Output
GPIO25	RxD1	Input
GPIO31	DSR1#	Input
GPIO30	DTR1#	Output
GPIO28	CTS1#	Input
GPIO27	RTS1#	Output
GPIO29	DCD1#	Input

The GIU drives inputs to the primary serial interface based on the settings in the GPIO Mode registers and the GPSICTL register (address: 0x0B00 031A). Bit 15, LOOPBK1, of the GPSICTL register is the control bit for the primary serial interface (for additional information, see **18.3.14 GPSICTL (0x0B00 031A)**).

When a GPIO pin has been assigned to provide one of the primary serial interface inputs, RxD1, DTR1#, RTS1#, or DCD1#, the GIU simply passes the signal driven on the GPIO pin to the associated primary serial interface input. Otherwise, the GIU drives these signals based on the value programmed in the GPSICTL register as follows:

Table 18-5. Primary Serial Interface Loopback Control

LOOPBK1 bit value	Source for driving primary serial interface input
0	DSR1# driven with REGDSR1 (bit 9) value CTS1# driven with REGCTS1 (bit 10) value DCD1# driven with REGDCD1 (bit 8) value RxD1 driven with REGRXD1 (bit 11) value
1	DSR1# driven with primary serial interface DTR1# output CTS1# driven with primary serial interface RTS1# output DCD1# driven with REGDCD1 (bit 8) value RxD1 driven with REGRXD1 (bit 11) value

The control bit for the secondary serial interface is bit 7, LOOKBK2, of the GPSICTL register (address: 0x0B00 031A) (for additional information, see **18.3.14 GPSICTL (0x0B00 031A)**).

The secondary serial interface utilizes the dedicated IRDIN/RxD2 and IRDOUT/TxD2 pins. The line control signals, DTR2#, RTS2#, DCD2#, DSR2#, and CTS2# are enabled by writing to the GPIO Mode registers and are utilized through the following GPIO pins:

Table 18-6. Secondary Serial Interface Signals Using GPIO Pins

GPIO pin	Secondary serial interface signal	Type
GPIO9	CTS2#	Input
GPIO8	DSR2#	Input
GPIO6	RTS2#	Output
GPIO5	DCD2#	Input
GPIO7	DTR2#	Output

The transmit and receive signals, TxD2 and RxD2, are enabled by writing to the SIURSEL_2 register in SIU2 block.

Control of the secondary serial interface line status inputs is identical to that of the primary serial interface. That is, when a GPIO pin has been enabled to provide a line status signal for the secondary serial interface, the signal input on that GPIO pin is passed unmodified to the secondary serial interface. Otherwise, the GIU drives these signals based on the value programmed in the GPSICTL register as follows:

Table 18-7. Secondary Serial Interface Loopback Control

LOOPBK2 bit value	Source for driving secondary serial interface input
0	DSR2# driven with REGDSR2 (bit 1) value CTS2# driven with REGCTS2 (bit 2) value DCD2# driven with REGDCD2 (bit 0) value
1	DSR2# driven with secondary serial interface DTR2# output CTS2# driven with secondary serial interface RTS2# output DCD2# driven with REGDCD2 (bit 0) value

Note that the GIU does not drive the secondary serial interface RxD2 input. This signal is always available to the serial interface as either IRDIN or RxD2.

18.2.3 LCD interface

The GIU supports two functions for the LCD interface. The first is pin mapping for 8-bit STN color LCD panel support. The second is pin mapping for support of an external LCDC with integrated frame buffer RAM.

For additional details about the LCD registers, see **CHAPTER 26 LCD CONTROLLER**.

(1) STN color LCD interface pin mapping

The color LCD panel interface is enabled by writing to the GPIO Mode registers and utilizes the following GPIO pins:

Table 18-8. STN Color LCD Interface Signals

GPIO pin	LCD signal	Type
GPIO(15:12)	FPD(7:4)	Output

(2) External LCDC pin mapping

The GIU can be configured to provide an interface to an external LCDC by setting the LCDGPEN bit of the LCDGPMD register to 1. In this mode the following internal LCD controller pins are redefined to support the external LCDC interface:

Table 18-9. External LCDC Interface Signals

LCD pin	External LCDC interface signal	Type
SHCLK	LCDCS#	Output
LOCLK	MEMCS16#	Input
VPLCD	General-purpose output (VPGPIO1)	Output
VPBIAS	General-purpose output (VPGPIO0)	Output

The LCDCS# output is generated from address decode logic in the GIU. The address range can be specified by programming the LCDGPMD register. The following address ranges are supported:

- (1) 0x1338 0000 to 0x133F FFFF (512KB)
- (2) 0x133C 0000 to 0x133F FFFF (256KB)
- (3) 0x133E 0000 to 0x133F FFFF (128KB)
- (4) 0x130A 0000 to 0x130A FFFF (64KB PC compatible address space)

Remark All memory cycles that access the external LCDC address space are treated as 16-bit cycles.

The MEMCS16# input is provided to support external memory devices (besides the external LCDC) which need 16-bit cycle support. During an external memory cycle, if the MEMCS16# input is enabled and asserted, the ISA bridge will generate a 16-bit cycle.

The VPLCD and VPBIAS outputs are defined as general-purpose outputs (VPGPIO1, VPGPIO0) when the LCDGPEN bit of the LCDGPMD register is set to 1.

18.2.4 Programmable chip selects

The GIU provides two programmable chip selects, PCS(1:0)#. These chip selects are available on the following GPIO pins:

Table 18-10. Programmable Chip Select Signals

GPIO pin	Programmable chip select	Type
GPIO11	PCS1#	Output
GPIO3	PCS0#	Output

Each programmable chip select can be defined as memory- or I/O-mapped, 8- or 16-bit data width, and 1 to 64K bytes of address ranges supporting. The chip selects can also be qualified with I/O or memory read or write strobes.

18.2.5 16-bit cycle support

The GIU generates two internal outputs (gpiocs16_l and gpmemcs16_l) to the internal ISA bus to signal the data width of the target of an external ISA cycle. These outputs are AND'ed with the outputs from other internal blocks to drive the ISA Bridge inputs.

The gpiocs16_l output is controlled by either programmable chip select through the PCSMODE register (0x0B00 032C) or IOCS16#/GPIO19 pin. When a programmable chip select has been defined as I/O mapped and 16-bit data width, the gpiocs16_l output is asserted while the I/O cycle address is within the range specified for the programmable chip select. When the IOCS16#/GPIO19 pin has been configured as IOCS16#, the gpiocs16_l follows the state of IOCS16#.

The gpmemcs16_l output is controlled by programmable chip select, LCDCS# or LOCLK/MEMCS16# pin. When a programmable chip select has been defined as memory mapped and 16-bit data width, the gpmemcs16_l output is asserted while the memory cycle address is within the range specified for the programmable chip select. When LOCLK/MEMCS16# pin has been configured as MEMCS16#, the gpmemcs16_l follows the state of MEMCS16#.

When mapped as an 8-bit device, it is controlled through IOCS16#/GPIO19 pin. When mapped as a 16-bit device, it is controlled through the GIU.

18.2.6 General purpose input/output

Each one of the 32 GPIO pins can be enabled to provide general-purpose input or general-purpose output capabilities. When a pin is configured as general-purpose output, a value written to the GPDATLREG register or the GPDATHREG register appears on its corresponding GPIO pin. When a pin is configured as a general-purpose input, a value driven on the GPIO pin can be read from its corresponding data bit of the GPDATLREG or GPDATHREG register.

18.2.7 Interrupt requests and wake-up events

Each of the lower 16 GPIO pins, GPIO(15:0), can be defined as an interrupt request input. The GIU provides a single asynchronous interrupt request output to the MBA Host Bridge, GPIOINTR. The MBA Host Bridge is responsible for synchronizing this interrupt request with the MasterOut clock (internal).

The GIU provides a total of 5 registers to support GPIO interrupt requests. The interrupt enable register, GPINTEN, is used to enable interrupt requests on a particular GPIO pin. The interrupt mask register, GPINTMSK, permits temporary masking of an interrupt request for a particular GPIO pin. The interrupt control registers, GPINTCTLH and GPINTCTLL, define the interrupt trigger type (edge or level) and the polarity of the interrupt requests input to the GPIO pin. The interrupt status register, GPINTSTAT, allows software to determine the source of the GPIO interrupt request.

The function of the enable, mask, polarity, and type bits are shown in the following figure:

Figure 18-1. GPIO(15:0) Interrupt Request Detecting Logic

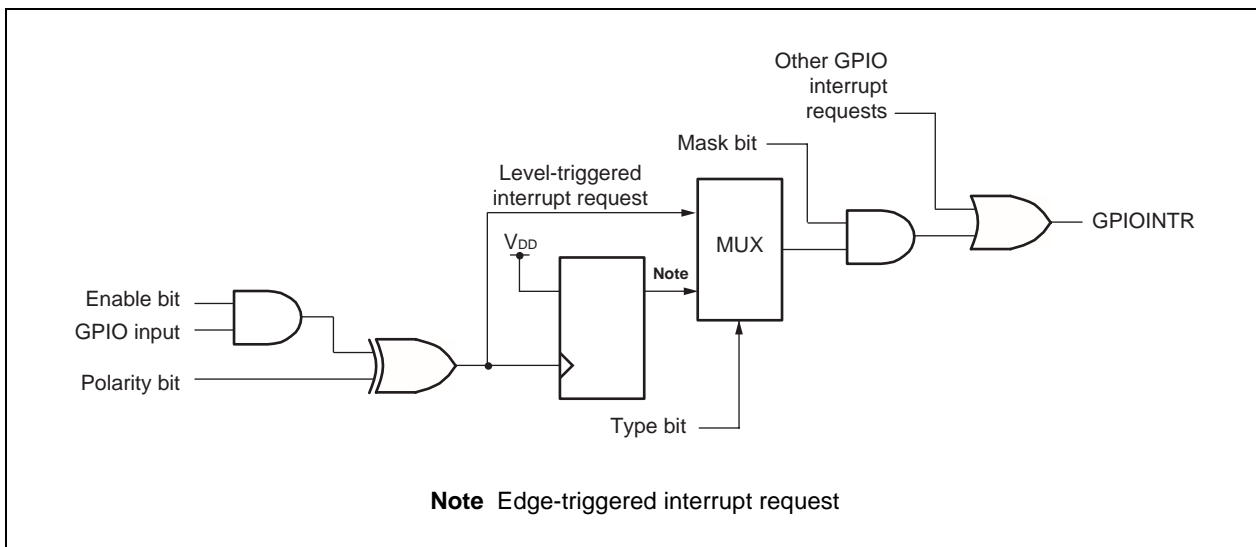

During Hibernate mode, any one of the GPIO(15:0) inputs can be enabled to generate a wake-up event. Wake-up event notification is asynchronous and output on the GPWAKEUP signal (internal)^{Note}. To enable GPIO wake-up events, the following conditions must be met:

- (1) Interrupts must be enabled for the GPIO pin (set in the GPINTEN register).
- (2) Interrupts must be unmasked for the GPIO pin (set in the GPINTMSK register).
- (3) The GPIO pin must be enabled during Hibernate mode (set in the GPHIBSTL register).

Note The state of this signal is displayed on GPWAKEUP bit of the PMUINTREG in the PMU.

18.3 Register Set

The GIU provides the following registers:

Table 18-11. GIU Registers (1/2)

Address	R/W	Register symbol	Function
0x0B00 0300	R/W	GPMD0REG	GPIO Mode 0 register
0x0B00 0302	R/W	GPMD1REG	GPIO Mode 1 register
0x0B00 0304	R/W	GPMD2REG	GPIO Mode 2 register
0x0B00 0306	R/W	GPMD3REG	GPIO Mode 3 register
0x0B00 0308	R/W	GPDATAHREG	GPIO data high register
0x0B00 030A	R/W	GPDATAHREG	GPIO data low register
0x0B00 030C	R/W	GPINTEN	GPIO interrupt enable register
0x0B00 030E	R/W	GPINTMSKL	GPIO interrupt mask register
0x0B00 0310	R/W	GPINTTYPH	GPIO interrupt type high register
0x0B00 0312	R/W	GPINTTYPL	GPIO interrupt type low register
0x0B00 0314	R/W	GPINTSTAT	GPIO interrupt status register
0x0B00 0316	R/W	GPHIBSTH	GPIO Hibernate pin state high register
0x0B00 0318	R/W	GPHIBSTL	GPIO Hibernate pin state low register
0x0B00 031A	R/W	GPSICTL	GPIO serial interface control register
0x0B00 031C	R/W	KEYEN	Keyboard scan pin enable register
0x0B00 0320	R/W	PCS0STRA	Programmable chip select 0 start address register
0x0B00 0322	R/W	PCS0STPA	Programmable chip select 0 stop address register
0x0B00 0324	R/W	PCS0HIA	Programmable chip select 0 high address register
0x0B00 0326	R/W	PCS1STRA	Programmable chip select 1 start address register
0x0B00 0328	R/W	PCS1STPA	Programmable chip select 1 stop address register
0x0B00 032A	R/W	PCS1HIA	Programmable chip select 1 high address register
0x0B00 032C	R/W	PCSMODE	Programmable chip select mode register
0x0B00 032E	R/W	LCDGPMODE	LCD general-purpose mode register

Table 18-11. GIU Registers (2/2)

Address	R/W	Register symbol	Function
0x0B00 0330	R/W	MISCREG0	Miscellaneous battery backed registers for non-volatile storage
0x0B00 0332	R/W	MISCREG1	
0x0B00 0334	R/W	MISCREG2	
0x0B00 0336	R/W	MISCREG3	
0x0B00 0338	R/W	MISCREG4	
0x0B00 033A	R/W	MISCREG5	
0x0B00 033C	R/W	MISCREG6	
0x0B00 033D	R/W	MISCREG7	
0x0B00 0340	R/W	MISCREG8	
0x0B00 0342	R/W	MISCREG9	
0x0B00 0344	R/W	MISCREG10	
0x0B00 0346	R/W	MISCREG11	
0x0B00 0348	R/W	MISCREG12	
0x0B00 034A	R/W	MISCREG13	
0x0B00 034C	R/W	MISCREG14	
0x0B00 034E	R/W	MISCREG15	

18.3.1 GPMD0REG (0x0B00 0300)

(1/2)

Bit	15	14	13	12	11	10	9	8
Name	GP7MD1	GP7MD0	GP6MD1	GP6MD0	GP5MD1	GP5MD0	GP4MD1	GP4MD0
R/W	R/W	R/W	R/W	R/W	R/W	R/W	R/W	R/W
RTCST	0	0	0	0	0	0	0	0
Other resets	Note	Note	Note	Note	Note	Note	Note	Note

Bit	7	6	5	4	3	2	1	0
Name	GP3MD1	GP3MD0	GP2MD1	GP2MD0	GP1MD1	GP1MD0	GP0MD1	GP0MD0
R/W	R/W	R/W	R/W	R/W	R/W	R/W	R/W	R/W
RTCST	0	0	0	0	0	0	0	0
Other resets	Note	Note	Note	Note	Note	Note	Note	Note

Bit	Name	Function
15, 14	GP7MD(1:0)	These bits control direction and function of the GPIO7 pin as follows: 00 : General-purpose input 01 : RFU 10 : General-purpose output 11 : Secondary RS-232-C DTR2# output
13, 12	GP6MD(1:0)	These bits control direction and function of the GPIO6 pin as follows: 00 : General-purpose input 01 : RFU 10 : General-purpose output 11 : Secondary RS-232-C RTS2# output
11, 10	GP5MD(1:0)	These bits control direction and function of the GPIO5 pin as follows: 00 : General-purpose input 01 : Secondary RS-232-C DCD2# input 10 : General-purpose output 11 : RFU
9, 8	GP4MD(1:0)	These bits control direction and function of the GPIO4 pin as follows: 00 : General-purpose input 01 : RFU 10 : General-purpose output 11 : RFU
7, 6	GP3MD(1:0)	These bits control direction and function of the GPIO3 pin as follows: 00 : General-purpose input 01 : RFU 10 : General-purpose output 11 : Programmable chip select 0 output

Note Hold the value before reset

(2/2)

Bit	Name	Function
5, 4	GP2MD(1:0)	These bits control direction and function of the GPIO2 pin as follows: 00 : General-purpose input 01 : CSI SCK input 10 : General-purpose output 11 : RFU
3, 2	GP1MD(1:0)	These bits control direction and function of the GPIO1 pin as follows: 00 : General-purpose input 01 : RFU 10 : General-purpose output 11 : CSI SO output
1, 0	GP0MD(1:0)	These bits control direction and function of the GPIO0 pin as follows: 00 : General-purpose input 01 : CSI SI input 10 : General-purpose output 11 : RFU

18.3.2 GPMD1REG (0x0B00 0302)

(1/2)

Bit	15	14	13	12	11	10	9	8
Name	GP15MD1	GP15MD0	GP14MD1	GP14MD0	GP13MD1	GP13MD0	GP12MD1	GP12MD0
R/W	R/W	R/W	R/W	R/W	R/W	R/W	R/W	R/W
RTCRST	0	0	0	0	0	0	0	0
Other resets	Note	Note	Note	Note	Note	Note	Note	Note

Bit	7	6	5	4	3	2	1	0
Name	GP11MD1	GP11MD0	GP10MD1	GP10MD0	GP9MD1	GP9MD0	GP8MD1	GP8MD0
R/W	R/W	R/W	R/W	R/W	R/W	R/W	R/W	R/W
RTCRST	0	0	0	0	0	0	0	0
Other resets	Note	Note	Note	Note	Note	Note	Note	Note

Bit	Name	Function
15, 14	GP15MD(1:0)	These bits control direction and function of the GPIO15 pin as follows: 00 : General-purpose input 01 : CD2# input 10 : General-purpose output 11 : Color LCD FPD7 output
13, 12	GP14MD(1:0)	These bits control direction and function of the GPIO14 pin as follows: 00 : General-purpose input 01 : CD1# input 10 : General-purpose output 11 : Color LCD FPD6 output
11, 10	GP13MD(1:0)	These bits control direction and function of the GPIO13 pin as follows: 00 : General-purpose input 01 : RFU 10 : General-purpose output 11 : Color LCD FPD5 output
9, 8	GP12MD(1:0)	These bits control direction and function of the GPIO12 pin as follows: 00 : General-purpose input 01 : RFU 10 : General-purpose output 11 : Color LCD FPD4 output
7, 6	GP11MD(1:0)	These bits control direction and function of the GPIO11 pin as follows: 00 : General-purpose input 01 : RFU 10 : General-purpose output 11 : Programmable chip select 1 output

Note Hold the value before reset

Remark When GPIO15 or GPIO14 are not defined as CD2# or CD1#, the corresponding internal card detect signals to CompactFlash Controller (ECU) are held low (card detect are active).

(2/2)

Bit	Name	Function
5, 4	GP10MD(1:0)	These bits control direction and function of the GPIO10 pin as follows: 00 : General-purpose input 01 : CSI FRM input 10 : General-purpose output 11 : SYSCLK output
3, 2	GP9MD(1:0)	These bits control direction and function of the GPIO9 pin as follows: 00 : General-purpose input 01 : Secondary RS-232-C CTS2# input 10 : General-purpose output 11 : RFU
1, 0	GP8MD(1:0)	These bits control direction and function of the GPIO8 pin as follows: 00 : General-purpose input 01 : Secondary RS-232-C DSR2# input 10 : General-purpose output 11 : RFU

18.3.3 GPMD2REG (0x0B00 0304)

(1/2)

Bit	15	14	13	12	11	10	9	8
Name	GP23MD1	GP23MD0	GP22MD1	GP22MD0	GP21MD1	GP21MD0	GP20MD1	GP20MD0
R/W	R/W	R/W	R/W	R/W	R/W	R/W	R/W	R/W
RTCST	0	0	0	0	0	0	0	0
Other resets	Note	Note	Note	Note	Note	Note	Note	Note

Bit	7	6	5	4	3	2	1	0
Name	GP19MD1	GP19MD0	GP18MD1	GP18MD0	GP17MD1	GP17MD0	GP16MD1	GP16MD0
R/W	R/W	R/W	R/W	R/W	R/W	R/W	R/W	R/W
RTCST	0	0	0	0	0	0	0	0
Other resets	Note	Note	Note	Note	Note	Note	Note	Note

Bit	Name	Function
15, 14	GP23MD(1:0)	These bits control direction and function of the GPIO23 pin as follows: 00 : General-purpose input 01 : RFU 10 : General-purpose output 11 : ROMCS1# output
13, 12	GP22MD(1:0)	These bits control direction and function of the GPIO22 pin as follows: 00 : General-purpose input 01 : RFU 10 : General-purpose output 11 : ROMCS0# output
11, 10	GP21MD(1:0)	These bits control direction and function of the GPIO21 pin as follows: 00 : General-purpose input 01 : RFU 10 : General-purpose output 11 : RESET# output
9, 8	GP20MD(1:0)	These bits control direction and function of the GPIO20 pin as follows: 00 : General-purpose input 01 : RFU 10 : LCD M output 11 : UBE# output
7, 6	GP19MD(1:0)	These bits control direction and function of the GPIO19 pin as follows: 00 : General-purpose input 01 : IOCS16# input 10 : General-purpose output 11 : RFU

Note Hold the value before reset

Caution LCD M output can not be used in the Vr4181 of Rev.1.0.

Bit	Name	Function
5, 4	GP18MD(1:0)	These bits control direction and function of the GPIO18 pin as follows: 00 : General-purpose input 01 : IORDY input 10 : General-purpose output 11 : RFU
3, 2	GP17MD(1:0)	These bits control direction and function of the GPIO17 pin as follows: 00 : General-purpose input 01 : RFU 10 : General-purpose output 11 : IOWR# output
1, 0	GP16MD(1:0)	These bits control direction and function of the GPIO16 pin as follows: 00 : General-purpose input 01 : RFU 10 : General-purpose output 11 : IORD# output

18.3.4 GPMD3REG (0x0B00 0306)

(1/2)

Bit	15	14	13	12	11	10	9	8
Name	GP31MD1	GP31MD0	GP30MD1	GP30MD0	GP29MD1	GP29MD0	GP28MD1	GP28MD0
R/W	R/W	R/W	R/W	R/W	R/W	R/W	R/W	R/W
RTCST	0	0	0	0	0	0	0	0
Other resets	Note	Note	Note	Note	Note	Note	Note	Note

Bit	7	6	5	4	3	2	1	0
Name	GP27MD1	GP27MD0	GP26MD1	GP26MD0	GP25MD1	GP25MD0	GP24MD1	GP24MD0
R/W	R/W	R/W	R/W	R/W	R/W	R/W	R/W	R/W
RTCST	0	0	0	0	0	0	0	0
Other resets	Note	Note	Note	Note	Note	Note	Note	Note

Bit	Name	Function
15, 14	GP31MD(1:0)	These bits control direction and function of the GPIO31 pin as follows: 00 : General-purpose input 01 : Primary RS-232-C DSR1# input 10 : General-purpose output 11 : RFU
13, 12	GP30MD(1:0)	These bits control direction and function of the GPIO30 pin as follows: 00 : General-purpose input 01 : RFU 10 : General-purpose output 11 : Primary RS-232-C DTR1# output
11, 10	GP29MD(1:0)	These bits control direction and function of the GPIO29 pin as follows: 00 : General-purpose input 01 : Primary RS-232-C DCD1# input 10 : General-purpose output 11 : RFU
9, 8	GP28MD(1:0)	These bits control direction and function of the GPIO28 pin as follows: 00 : General-purpose input 01 : RFU Primary RS-232-C CTS1# input 10 : General-purpose output 11 : RFU
7, 6	GP27MD(1:0)	These bits control direction and function of the GPIO27 pin as follows: 00 : General-purpose input 01 : RFU 10 : General-purpose output 11 : Primary RS-232-C RTS1# output

Note Hold the value before reset

(2/2)

Bit	Name	Function
5, 4	GP26MD(1:0)	These bits control direction and function of the GPIO26 pin as follows: 00 : General-purpose input 01 : RFU 10 : General-purpose output 11 : Primary RS-232-C TxD1 output
3, 2	GP25MD(1:0)	These bits control direction and function of the GPIO25 pin as follows: 00 : General-purpose input 01 : Primary RS-232-C RxD1 input 10 : General-purpose output 11 : RFU
1, 0	GP24MD(1:0)	These bits control direction and function of the GPIO24 pin as follows: 00 : General-purpose input 01 : RFU 10 : General-purpose output 11 : ROMCS2# output

18.3.5 GPDATHREG (0x0B00 0308)

Bit	15	14	13	12	11	10	9	8
Name	GPDAT31	GPDAT30	GPDAT29	GPDAT28	GPDAT27	GPDAT26	GPDAT25	GPDAT24
R/W	R	R	R	R	R	R	R	R
RTCRST	0	0	0	0	0	0	0	0
Other resets	Note	Note	Note	Note	Note	Note	Note	Note

Bit	7	6	5	4	3	2	1	0
Name	GPDAT23	GPDAT22	GPDAT21	GPDAT20	GPDAT19	GPDAT18	GPDAT17	GPDAT16
R/W	R/W	R/W	R/W	R/W	R/W	R/W	R/W	R/W
RTCRST	0	0	0	0	0	0	0	0
Other resets	Note	Note	Note	Note	Note	Note	Note	Note

Bit	Name	Function
15 to 0	GPDAT(31:16)	General-purpose data. GPDAT31 corresponds to the GPIO31 pin, GPDAT30 to the GPIO30 pin, and so on. When a GPIO pin is configured as a general-purpose input, the value of the pin can be read from this register. When the pin is defined as a general-purpose output, the value written to this register appears on the GPIO pin. When one of the GPIO(31:16) pins is configured as other function, the corresponding bit value in this register is invalid.

Note Hold the value before reset

18.3.6 GPDATLREG (0x0B00 030A)

Bit	15	14	13	12	11	10	9	8
Name	GPDAT15	GPDAT14	GPDAT13	GPDAT12	GPDAT11	GPDAT10	GPDAT9	GPDAT8
R/W	R/W	R/W	R/W	R/W	R/W	R/W	R/W	R/W
RTCRST	0	0	0	0	0	0	0	0
Other resets	Note	Note	Note	Note	Note	Note	Note	Note

Bit	7	6	5	4	3	2	1	0
Name	GPDAT7	GPDAT6	GPDAT5	GPDAT4	GPDAT3	GPDAT2	GPDAT1	GPDAT0
R/W	R/W	R/W	R/W	R/W	R/W	R/W	R/W	R/W
RTCRST	0	0	0	0	0	0	0	0
Other resets	Note	Note	Note	Note	Note	Note	Note	Note

Bit	Name	Function
15 to 0	GPDAT(15:0)	General-purpose Data. GPDAT15 corresponds to the GPIO15 pin, GPDAT14 to the GPIO14 pin, and so on. When a GPIO pin is configured as a general-purpose input, the value of the pin can be read from this register. When the pin is defined as a general-purpose output, the value written to this register appears on the GPIO pin. When one of the GPIO(15:0) pins is configured as other function, the corresponding bit value in this register is invalid.

Note Hold the value before reset

18.3.7 GPINTEN (0x0B00 030C)

Bit	15	14	13	12	11	10	9	8
Name	GIEN15	GIEN14	GIEN13	GIEN12	GIEN11	GIEN10	GIEN9	GIEN8
R/W	R/W	R/W	R/W	R/W	R/W	R/W	R/W	R/W
RTCST	0	0	0	0	0	0	0	0
Other resets	Note	Note	Note	Note	Note	Note	Note	Note

Bit	7	6	5	4	3	2	1	0
Name	GIEN7	GIEN6	GIEN5	GIEN4	GIEN3	GIEN2	GIEN1	GIEN0
R/W	R/W	R/W	R/W	R/W	R/W	R/W	R/W	R/W
RTCST	0	0	0	0	0	0	0	0
Other resets	Note	Note	Note	Note	Note	Note	Note	Note

Bit	Name	Function
15 to 0	GIEN(15:0)	GPIO interrupt enable bits. When one of the GPIO(15:0) pins is defined as a general-purpose input, the corresponding bit in this register enables interrupts for that pin as follows: 0 : Interrupt disabled 1 : Interrupt enabled

Note Hold the value before reset

Remark About the relationship between the GPINTEN and GPINTMSK registers, refer to **Figure 18-1. GPIO(15:0) Interrupt Request Detecting Logic.**

18.3.8 GPINTMSK (0x0B00 030E)

Bit	15	14	13	12	11	10	9	8
Name	GIMSK15	GIMSK14	GIMSK13	GIMSK12	GIMSK11	GIMSK10	GIMSK9	GIMSK8
R/W	R/W	R/W	R/W	R/W	R/W	R/W	R/W	R/W
RTCRST	1	1	1	1	1	1	1	1
Other resets	Note	Note	Note	Note	Note	Note	Note	Note

Bit	7	6	5	4	3	2	1	0
Name	GIMSK7	GIMSK6	GIMSK5	GIMSK4	GIMSK3	GIMSK2	GIMSK1	GIMSK0
R/W	R/W	R/W	R/W	R/W	R/W	R/W	R/W	R/W
RTCRST	1	1	1	1	1	1	1	1
Other resets	Note	Note	Note	Note	Note	Note	Note	Note

Bit	Name	Function
15 to 0	GIMSK(15:0)	GPIO interrupt mask bits. When a GPIO pin is defined as a general-purpose input and interrupts is enabled on that pin, the interrupt can be temporarily masked by setting the corresponding bit in this register as follows: 0 : Interrupt unmasked 1 : Interrupt masked

Note Hold the value before reset

Remark About the relationship between the GPINTEN and GPINTMSK registers, refer to **Figure 18-1. GPIO(15:0) Interrupt Request Detecting Logic.**

18.3.9 GPINTTYPH (0x0B00 0310)

(1/2)

Bit	15	14	13	12	11	10	9	8
Name	I15TYP1	I15TYP0	I14TYP1	I14TYP0	I13TYP1	I13TYP0	I12TYP1	I12TYP0
R/W	R/W	R/W	R/W	R/W	R/W	R/W	R/W	R/W
RTCST	0	0	0	0	0	0	0	0
Other resets	Note	Note	Note	Note	Note	Note	Note	Note

Bit	7	6	5	4	3	2	1	0
Name	I11TYP1	I11TYP0	I10TYP1	I10TYP0	I9TYP1	I9TYP0	I8TYP1	I8TYP0
R/W	R/W	R/W	R/W	R/W	R/W	R/W	R/W	R/W
RTCST	0	0	0	0	0	0	0	0
Other resets	Note	Note	Note	Note	Note	Note	Note	Note

Bit	Name	Function
15, 14	I15TYP(1:0)	These bits define the type of interrupt generated when the GPIO15 pin is defined as a general-purpose input: 00 : Negative edge triggered interrupt 01 : Positive edge triggered interrupt 10 : Low level triggered interrupt 11 : High level triggered interrupt
13, 12	I14TYP(1:0)	These bits define the type of interrupt generated when the GPIO14 pin is defined as a general-purpose input: 00 : Negative edge triggered interrupt 01 : Positive edge triggered interrupt 10 : Low level triggered interrupt 11 : High level triggered interrupt
11, 10	I13TYP(1:0)	These bits define the type of interrupt generated when the GPIO13 pin is defined as a general-purpose input: 00 : Negative edge triggered interrupt 01 : Positive edge triggered interrupt 10 : Low level triggered interrupt 11 : High level triggered interrupt
9, 8	I12TYP(1:0)	These bits define the type of interrupt generated when the GPIO12 pin is defined as a general-purpose input: 00 : Negative edge triggered interrupt 01 : Positive edge triggered interrupt 10 : Low level triggered interrupt 11 : High level triggered interrupt

Note Hold the value before reset

Bit	Name	Function
7, 6	I11TYP(1:0)	<p>These bits define the type of interrupt generated when the GPIO11 pin is defined as a general-purpose input:</p> <p>00 : Negative edge triggered interrupt 01 : Positive edge triggered interrupt 10 : Low level triggered interrupt 11 : High level triggered interrupt</p>
5, 4	I10TYP(1:0)	<p>These bits define the type of interrupt generated when the GPIO10 pin is defined as a general-purpose input:</p> <p>00 : Negative edge triggered interrupt 01 : Positive edge triggered interrupt 10 : Low level triggered interrupt 11 : High level triggered interrupt</p>
3, 2	I9TYP(1:0)	<p>These bits define the type of interrupt generated when the GPIO9 pin is defined as a general-purpose input:</p> <p>00 : Negative edge triggered interrupt 01 : Positive edge triggered interrupt 10 : Low level triggered interrupt 11 : High level triggered interrupt</p>
1, 0	I8TYP(1:0)	<p>These bits define the type of interrupt generated when the GPIO8 pin is defined as a general-purpose input:</p> <p>00 : Negative edge triggered interrupt 01 : Positive edge triggered interrupt 10 : Low level triggered interrupt 11 : High level triggered interrupt</p>

18.3.10 GPINTTYPL (0x0B00 0312)

(1/2)

Bit	15	14	13	12	11	10	9	8
Name	I7TYP1	I7TYP0	I6TYP1	I6TYP0	I5TYP1	I5TYP0	I4TYP1	I4TYP0
R/W	R/W	R/W	R/W	R/W	R/W	R/W	R/W	R/W
RTCRST	0	0	0	0	0	0	0	0
Other resets	Note	Note	Note	Note	Note	Note	Note	Note

Bit	7	6	5	4	3	2	1	0
Name	I3TYP1	I3TYP0	I2TYP1	I2TYP0	I1TYP1	I1TYP0	I0TYP1	I0TYP0
R/W	R/W	R/W	R/W	R/W	R/W	R/W	R/W	R/W
RTCRST	0	0	0	0	0	0	0	0
Other resets	Note	Note	Note	Note	Note	Note	Note	Note

Bit	Name	Function
15, 14	I7TYP(1:0)	These bits define the type of interrupt generated when the GPIO7 pin is defined as a general-purpose input: 00 : Negative edge triggered interrupt 01 : Positive edge triggered interrupt 10 : Low level triggered interrupt 11 : High level triggered interrupt
13, 12	I6TYP(1:0)	These bits define the type of interrupt generated when the GPIO6 pin is defined as a general-purpose input: 00 : Negative edge triggered interrupt 01 : Positive edge triggered interrupt 10 : Low level triggered interrupt 11 : High level triggered interrupt
11, 10	I5TYP(1:0)	These bits define the type of interrupt generated when the GPIO5 pin is defined as a general-purpose input: 00 : Negative edge triggered interrupt 01 : Positive edge triggered interrupt 10 : Low level triggered interrupt 11 : High level triggered interrupt
9, 8	I4TYP(1:0)	These bits define the type of interrupt generated when the GPIO4 pin is defined as a general-purpose input: 00 : Negative edge triggered interrupt 01 : Positive edge triggered interrupt 10 : Low level triggered interrupt 11 : High level triggered interrupt

Note Hold the value before reset

Bit	Name	Function
7, 6	I3TYP(1:0)	<p>These bits define the type of interrupt generated when the GPIO3 pin is defined as a general-purpose input:</p> <p>00 : Negative edge triggered interrupt 01 : Positive edge triggered interrupt 10 : Low level triggered interrupt 11 : High level triggered interrupt</p>
5, 4	I2TYP(1:0)	<p>These bits define the type of interrupt generated when the GPIO2 pin is defined as a general-purpose input:</p> <p>00 : Negative edge triggered interrupt 01 : Positive edge triggered interrupt 10 : Low level triggered interrupt 11 : High level triggered interrupt</p>
3, 2	I1TYP(1:0)	<p>These bits define the type of interrupt generated when the GPIO1 pin is defined as a general-purpose input:</p> <p>00 : Negative edge triggered interrupt 01 : Positive edge triggered interrupt 10 : Low level triggered interrupt 11 : High level triggered interrupt</p>
1, 0	I0TYP(1:0)	<p>These bits define the type of interrupt generated when the GPIO0 pin is defined as a general-purpose input:</p> <p>00 : Negative edge triggered interrupt 01 : Positive edge triggered interrupt 10 : Low level triggered interrupt 11 : High level triggered interrupt</p>

18.3.11 GPINTSTAT (0x0B00 0314)

Bit	15	14	13	12	11	10	9	8
Name	GISTS15	GISTS14	GISTS13	GISTS12	GISTS11	GISTS10	GISTS9	GISTS8
R/W	R/W	R/W	R/W	R/W	R/W	R/W	R/W	R/W
RTCST	0	0	0	0	0	0	0	0
Other resets	Note	Note	Note	Note	Note	Note	Note	Note

Bit	7	6	5	4	3	2	1	0
Name	GISTS7	GISTS6	GISTS5	GISTS4	GISTS3	GISTS2	GISTS1	GISTS0
R/W	R/W	R/W	R/W	R/W	R/W	R/W	R/W	R/W
RTCST	0	0	0	0	0	0	0	0
Other resets	Note	Note	Note	Note	Note	Note	Note	Note

Bit	Name	Function
15 to 0	GISTS(15:0)	GPIO interrupt request status bits. When a GPIO pin is defined as a general-purpose input, these bits reflect the interrupt request status as follows: 0 : No Interrupt request pending 1 : Interrupt request pending

Note Hold the value before reset

Interrupt request pending status is reflected regardless of the setting of the interrupt mask bits. Therefore, the status of an interrupt request can be returned as pending when this register is read even though the interrupt is masked.

When a GPIO interrupt request is defined as an edge triggered type, the interrupt request is cleared by writing 1 to the corresponding bit of this register. For example, if GPIO11 is defined as an edge triggered interrupt request input, an interrupt request generated by this pin would be cleared by writing 1 to the bit 11 of this register.

18.3.12 GPHIBSTH (0x0B00 0316)

Bit	15	14	13	12	11	10	9	8
Name	GPHST31	GPHST30	GPHST29	GPHST28	GPHST27	GPHST26	GPHST25	GPHST24
R/W	R/W	R/W	R/W	R/W	R/W	R/W	R/W	R/W
RTCRST	0	0	0	0	0	0	0	0
Other resets	Note	Note	Note	Note	Note	Note	Note	Note

Bit	7	6	5	4	3	2	1	0
Name	GPHST23	GPHST22	GPHST21	GPHST20	GPHST19	GPHST18	GPHST17	GPHST16
R/W	R/W	R/W	R/W	R/W	R/W	R/W	R/W	R/W
RTCRST	0	0	0	0	0	0	0	0
Other resets	Note	Note	Note	Note	Note	Note	Note	Note

Bit	Name	Function
15 to 0	GPHST(31:16)	<p>GPIO Hibernate pin state control. These bits determine the state of GPIO(31:16) during Hibernate mode as follows:</p> <p>0 : Output pin is in high impedance Input pin is ignored during Hibernate mode</p> <p>1 : Output pin remains actively driven Input pin is monitored during Hibernate mode</p>

Note Hold the value before reset

Caution GPIO29 pin (DCD1#) can be set to 1 and monitored during Hibernate mode. The GPHST bits for all other GPIO pins configured as inputs should be reset to 0. The stability of the register is uncertain under any other set of conditions.

18.3.13 GPHIBSTL (0x0B00 0318)

Bit	15	14	13	12	11	10	9	8
Name	GPHST15	GPHST14	GPHST13	GPHST12	GPHST11	GPHST10	GPHST9	GPHST8
R/W	R/W	R/W	R/W	R/W	R/W	R/W	R/W	R/W
RTCST	0	0	0	0	0	0	0	0
Other resets	Note	Note	Note	Note	Note	Note	Note	Note

Bit	7	6	5	4	3	2	1	0
Name	GPHST7	GPHST6	GPHST5	GPHST4	GPHST3	GPHST2	GPHST1	GPHST0
R/W	R/W	R/W	R/W	R/W	R/W	R/W	R/W	R/W
RTCST	0	0	0	0	0	0	0	0
Other resets	Note	Note	Note	Note	Note	Note	Note	Note

Bit	Name	Function
15 to 0	GPHST(15:0)	<p>GPIO Hibernate pin state control. These bits determine the state of GPIO(15:0) during Hibernate mode as follows:</p> <ul style="list-style-type: none"> 0 : Output pin is in high impedance Input pin is ignored during Hibernate mode 1 : Output pin remains actively driven Input pin is monitored during Hibernate mode

Note Hold the value before reset

Remark In order to support wake-up events on one of the GPIO(15:0) pins, the associated GPHST bit must be set to 1.

18.3.14 GPSICTL (0x0B00 031A)

(1/2)

Bit	15	14	13	12	11	10	9	8
Name	LOOPBK1	Reserved	Reserved	Reserved	REGRXD1	REGCTS1	REGDSR1	REGDCD1
R/W	R/W	R	R	R	R/W	R/W	R/W	R/W
RTCRST	0	0	0	0	1	1	1	1
Other resets	Note	0	0	0	Note	Note	Note	Note

Bit	7	6	5	4	3	2	1	0
Name	LOOPBK2	Reserved	Reserved	Reserved	Reserved	REGCTS2	REGDSR2	REGDCD2
R/W	R/W	R	R	R	R	R/W	R/W	R/W
RTCRST	0	0	0	0	0	1	1	1
Other resets	Note	0	0	0	0	Note	Note	Note

Bit	Name	Function
15	LOOPBK1	<p>Loopback enable for primary serial interface. When GPIO pins have not been allocated for the primary line status signals DSR1# and/or CTS1#, this bit can be set to 1 to allow the primary serial interface line control output signals to be connected to the line status input signals as follows:</p> <p>DTR1# output from serial interface drives the DSR1# input to serial interface RTS1# output from serial interface drives the CTS1# input to serial interface</p>
14 to 12	Reserved	0 is returned when read
11	REGRXD1	When a GPIO pin has not been enabled to provide RxD1, the RxD1 input to the primary serial interface is driven with the value of this bit.
10	REGCTS1	When the LOOPBK1 bit is reset to 0 and a GPIO pin has not been enabled to provide CTS1#, the CTS1# input to the primary serial interface is driven with the value of this bit.
9	REGDSR1	When the LOOPBK1 bit is reset to 0 and a GPIO pin has not been enabled to provide DSR1#, the DSR1# input to the primary serial interface is driven with the value of this bit.
8	REGDCD1	When a GPIO pin has not been enabled to provide DCD1#, the DCD1# input to the primary serial interface is driven with the value of this bit.

Note Hold the value before reset

Bit	Name	Function
7	LOOPBK2	<p>Loopback enable for secondary serial interface. When GPIO pins have not be allocated for the secondary line status signals DSR2# and/or CTS2#, this bit can be set to 1 to allow the secondary serial interface line control output signals to be connected to the line status input signals as follows:</p> <p>DTR2# output from serial interface drives the DSR2# input to serial interface RTS2# output from serial interface drives the CTS2# input to serial interface</p>
6 to 3	Reserved	0 is returned when read
2	REGCTS2	When the LOOPBK2 bit is reset to 0 and a GPIO pin has not been enabled to provide CTS2#, the CTS2# input to the secondary serial interface is driven with the value of this bit.
1	REGDSR2	When the LOOPBK2 bit is reset to 0 and a GPIO pin has not been enabled to provide DSR2#, the DSR2# input to the secondary serial interface is driven with the value of this bit.
0	REGDCD2	When a GPIO pin has not been enabled to provide DCD2#, the DCD2# input to the secondary serial interface is driven with the value of this bit.

18.3.15 KEYEN (0x0B00 031C)

Bit	15	14	13	12	11	10	9	8
Name	KEYSEL	Reserved	Reserved	Reserved	Reserved	Reserved	Reserved	Reserved
R/W	R/W	R	R	R	R	R	R	R
RTCRST	0	0	0	0	0	0	0	0
Other resets	Note	0	0	0	0	0	0	0

Bit	7	6	5	4	3	2	1	0
Name	CFHIBEN	Reserved	Reserved	Reserved	Reserved	Reserved	Reserved	Reserved
R/W	R/W	R	R	R	R	R	R	R
RTCRST	0	0	0	0	0	0	0	0
Other resets	Note	0	0	0	0	0	0	0

Bit	Name	Function
15	KEYSEL	Keyboard scan pin enable. This bit causes the pins assigned to support the CompactFlash interface to be redefined to support the keyboard scan interface. 0 : CompactFlash interface enabled and keyboard scan disabled 1 : Keyboard scan interface enabled and CompactFlash disabled
14 to 8	Reserved	0 is returned when read
7	CFHIBEN	CompactFlash interface enable during Hibernate mode 0 : Disable 1 : Enable
6 to 0	Reserved	0 is returned when read

Note Hold the value before reset

The GIU only provides the output signal, KEYSEL. An external logic is responsible for multiplexing the pin input, pin output, and pin buffer enable control from the ECU and the KIU.

When the CompactFlash interface is enabled during Hibernate mode, a high-to-low transition on the CompactFlash CF_BUSY pin will cause the Vr4181 to wake up and return to Fullspeed mode.

18.3.16 PCS0STRA (0x0B00 0320)

Bit	15	14	13	12	11	10	9	8
Name	PCS0STRA 15	PCS0STRA 14	PCS0STRA 13	PCS0STRA 12	PCS0STRA 11	PCS0STRA 10	PCS0STRA 9	PCS0STRA 8
R/W	R/W	R/W	R/W	R/W	R/W	R/W	R/W	R/W
RTCRST	0	0	0	0	0	0	0	0
Other resets	Note	Note	Note	Note	Note	Note	Note	Note

Bit	7	6	5	4	3	2	1	0
Name	PCS0STRA 7	PCS0STRA 6	PCS0STRA 5	PCS0STRA 4	PCS0STRA 3	PCS0STRA 2	PCS0STRA 1	PCS0STRA 0
R/W	R/W	R/W	R/W	R/W	R/W	R/W	R/W	R/W
RTCRST	0	0	0	0	0	0	0	0
Other resets	Note	Note	Note	Note	Note	Note	Note	Note

Bit	Name	Function
15 to 0	PCS0STRA(15:0)	Programmable chip select 0 start address. These bits determine the starting address for the memory or I/O chip select.

Note Hold the value before reset

18.3.17 PCS0STPA (0x0B00 0322)

Bit	15	14	13	12	11	10	9	8
Name	PCS0STPA 15	PCS0STPA 14	PCS0STPA 13	PCS0STPA 12	PCS0STPA 11	PCS0STPA 10	PCS0STPA 9	PCS0STPA 8
R/W	R/W	R/W	R/W	R/W	R/W	R/W	R/W	R/W
RTCRST	0	0	0	0	0	0	0	0
Other resets	Note	Note	Note	Note	Note	Note	Note	Note

Bit	7	6	5	4	3	2	1	0
Name	PCS0STPA 7	PCS0STPA 6	PCS0STPA 5	PCS0STPA 4	PCS0STPA 3	PCS0STPA 2	PCS0STPA 1	PCS0STPA 0
R/W	R/W	R/W	R/W	R/W	R/W	R/W	R/W	R/W
RTCRST	0	0	0	0	0	0	0	0
Other resets	Note	Note	Note	Note	Note	Note	Note	Note

Bit	Name	Function
15 to 0	PCS0STPA(15:0)	Programmable chip select 0 stop address. These bits determine the ending address for the memory or I/O chip select.

Note Hold the value before reset

18.3.18 PCS0HIA (0x0B00 0324)

Bit	15	14	13	12	11	10	9	8
Name	Reserved	Reserved	Reserved	Reserved	PCS0HIA 27	PCS0HIA 26	PCS0HIA 25	PCS0HIA 24
R/W	R	R	R	R	R/W	R/W	R/W	R/W
RTCRST	0	0	0	0	0	0	0	0
Other resets	0	0	0	0	Note1	Note1	Note1	Note1

Bit	7	6	5	4	3	2	1	0
Name	PCS0HIA 23	PCS0HIA 22	PCS0HIA 21	PCS0HIA 20	PCS0HIA 19	PCS0HIA 18	PCS0HIA 17	PCS0HIA 16
R/W	R/W	R/W	R/W	R/W	R/W	R/W	R/W	R/W
RTCRST	0	0	0	0	0	0	0	0
Other resets	Note1	Note1	Note1	Note1	Note1	Note1	Note1	Note1

Bit	Name	Function
15 to 12	Reserved	0 is returned when read
6 to 0	PCS0HIA(27:16)	<p>Programmable chip select 0 high address. A programmable chip select 0 will be generated when all of the following conditions have been met:</p> <ul style="list-style-type: none"> • The system address bits A(15:0) are equal to or greater than PCS0STRA(15:0) and equal to or less than PCS0STPA(15:0) ^{Note2} • The internal address bits A(27:16) are equal to PCS0HIA(27:16) • The read/write qualifier conditions specified by the PCSMODE register have been met.

Notes 1. Hold the value before reset

2. When PCS0 has been defined as a 16-bit chip select, address bit 0 is ignored.

18.3.19 PCS1STRA (0x0B00 0326)

Bit	15	14	13	12	11	10	9	8
Name	Reserved	PCS1STRA 14	PCS1STRA 13	PCS1STRA 12	PCS1STRA 11	PCS1STRA 10	PCS1STRA 9	PCS1STRA 8
R/W	R	R/W	R/W	R/W	R/W	R/W	R/W	R/W
RTCST	0	0	0	0	0	0	0	0
Other resets	0	Note	Note	Note	Note	Note	Note	Note

Bit	7	6	5	4	3	2	1	0
Name	PCS1STRA 7	PCS1STRA 6	PCS1STRA 5	PCS1STRA 4	PCS1STRA 3	PCS1STRA 2	PCS1STRA 1	PCS1STRA 0
R/W	R/W	R/W	R/W	R/W	R/W	R/W	R/W	R/W
RTCST	0	0	0	0	0	0	0	0
Other resets	Note	Note	Note	Note	Note	Note	Note	Note

Bit	Name	Function
15	Reserved	0 is returned when read
14 to 0	PCS1STRA(15:0)	Programmable chip select 1 start address. These bits determine the starting address for the memory or I/O chip select.

Note Hold the value before reset

18.3.20 PCS1STPA (0x0B00 0328)

Bit	15	14	13	12	11	10	9	8
Name	PCS1STPA 15	PCS1STPA 14	PCS1STPA 13	PCS1STPA 12	PCS1STPA 11	PCS1STPA 10	PCS1STPA 9	PCS1STPA 8
R/W	R/W	R/W	R/W	R/W	R/W	R/W	R/W	R/W
RTCST	0	0	0	0	0	0	0	0
Other resets	Note	Note	Note	Note	Note	Note	Note	Note

Bit	7	6	5	4	3	2	1	0
Name	PCS1STPA 7	PCS1STPA 6	PCS1STPA 5	PCS1STPA 4	PCS1STPA 3	PCS1STPA 2	PCS1STPA 1	PCS1STPA 0
R/W	R/W	R/W	R/W	R/W	R/W	R/W	R/W	R/W
RTCST	0	0	0	0	0	0	0	0
Other resets	Note	Note	Note	Note	Note	Note	Note	Note

Bit	Name	Function
15 to 0	PCS1STPA(15:0)	Programmable chip select 1 stop address. These bits determine the ending address for the memory or I/O chip select.

Note Hold the value before reset

18.3.21 PCS1HIA (0x0B00 032A)

Bit	15	14	13	12	11	10	9	8
Name	Reserved	Reserved	Reserved	Reserved	PCS1HIA 27	PCS1HIA 26	PCS1HIA 25	PCS1HIA 24
R/W	R	R	R	R	R/W	R/W	R/W	R/W
RTCRST	0	0	0	0	0	0	0	0
Other resets	0	0	0	0	Note1	Note1	Note1	Note1

Bit	7	6	5	4	3	2	1	0
Name	PCS1HIA 23	PCS1HIA 22	PCS1HIA 21	PCS1HIA 20	PCS1HIA 19	PCS1HIA 18	PCS1HIA 17	PCS1HIA 16
R/W	R/W	R/W	R/W	R/W	R/W	R/W	R/W	R/W
RTCRST	0	0	0	0	0	0	0	0
Other resets	Note1	Note1	Note1	Note1	Note1	Note1	Note1	Note1

Bit	Name	Function
15 to 12	Reserved	0 is returned when read
11 to 0	PCS1HIA(27:16)	<p>Programmable chip select 1 high address. A programmable chip select 1 will be generated when all of the following conditions have been met:</p> <ul style="list-style-type: none"> The system address bits A(15:0) are equal to or greater than PCS1STRA(15:0) and equal to or less than PCS1STPA(15:0) ^{Note2} The internal address bits A(27:16) are equal to PCS1HIA(27:16) The read/write qualifier conditions specified by the PCSMODE register have been met.

Notes 1. Hold the value before reset

2. When PCS1 has been defined as a 16-bit chip select, address bit 0 is ignored.

18.3.22 PCSMODE (0x0B00 032C)

Bit	15	14	13	12	11	10	9	8
Name	Reserved	Reserved	Reserved	Reserved	Reserved	Reserved	Reserved	Reserved
R/W	R	R	R	R	R	R	R	R
RTCST	0	0	0	0	0	0	0	0
Other resets	0	0	0	0	0	0	0	0

Bit	7	6	5	4	3	2	1	0
Name	PCS0MIOB	PCS0DSIZE	PCS0MD1	PCS0MD0	PCS0MIOB	PCS0DSIZE	PCS0MD1	PCS0MD0
R/W	R/W	R/W	R/W	R/W	R/W	R/W	R/W	R/W
RTCST	0	0	0	0	0	0	0	0
Other resets	Note	Note	Note	Note	Note	Note	Note	Note

Bit	Name	Function
15 to 8	Reserved	0 is returned when read
7	PCS1MIOB	Programmable chip select 1 memory or I/O enable 0 : Enabled only during I/O cycles 1 : Enabled only during memory cycles
6	PCS1DSIZE	Programmable chip select 1 data size 0 : Defined as an 8-bit device. During accesses to the address range specified for PCS1, 8-bit cycles will be generated unless MEMCS16# or IOCS16# is asserted by the external peripheral. 1 : Defined as a 16-bit device. During accesses to the address range specified for PCS1 16-bit cycles will be generated.
5, 4	PCS1MD(1:0)	Programmable chip select 1 mode 00 : Disabled 01 : Qualified with I/O or memory read strobe 10 : Qualified with I/O or memory write strobe 11 : Based on address decode only
3	PCS0MIOB	Programmable chip select 0 memory or I/O enable 0 : Enabled only during I/O cycles 1 : Enabled only during memory cycles
2	PCS0DSIZE	Programmable chip select 0 data size 0 : PCS0 defined as an 8-bit device. During accesses to the address range specified for PCS0, 8-bit cycles will be generated unless MEMCS16# or IOCS16# is asserted by the external peripheral. 1 : Defined as a 16-bit device. During accesses to the address range specified for PCS0 16-bit cycles will be generated.
1, 0	PCS0MD(1:0)	Programmable chip select 0 mode 00 : Disabled 01 : Qualified with I/O or Memory read strobe 10 : Qualified with I/O or Memory write strobe 11 : Based on address decode only

Note Hold the value before reset

18.3.23 LCDGPMODE (0x0B00 032E)

Bit	15	14	13	12	11	10	9	8
Name	Reserved	Reserved	Reserved	Reserved	Reserved	Reserved	Reserved	Reserved
R/W	R	R	R	R	R	R	R	R
RTCRST	0	0	0	0	0	0	0	0
Other resets	0	0	0	0	0	0	0	0

Bit	7	6	5	4	3	2	1	0
Name	LCDGPEN	Reserved	Reserved	Reserved	LCDCS1	LCDCS0	GPVPBIAS	GPVPLCD
R/W	R/W	R	R	R	R/W	R/W	R/W	R/W
RTCRST	0	0	0	0	0	0	0	0
Other resets	Note	0	0	0	Note	Note	Note	Note

Bit	Name	Function
15 to 8	Reserved	0 is returned when read
7	LCDGPEN	LCD interface GPIO enable 0 : Controlled by internal LCD controller 1 : Redefined as follows SHCLK ... LCDCS# LOCLK ... MEMCS16# VPLCD ... driven by GPVPLCD bit from this register VPBIAS ... driven by GPVPBIAS bit from this register
6 to 4	Reserved	0 is returned when read
3 to 2	LCDCS(1:0)	External LCDC frame buffer address select. These bits determine the address range that will cause the LCDCS# signal to be asserted. 00 : 0x130A 0000 to 0x130A FFFF (64KB PC compatible address space) 01 : 0x133E 0000 to 0x133F FFFF (128KB) 10 : 0x133C 0000 to 0x133F FFFF (256KB) 11 : 0x1338 0000 to 0x133F FFFF (512KB)
1	GPVPBIAS	General-purpose output control for VPBIAS pin. When the LCDGPEN bit is set to 1, the VPBIAS pin is driven by the value of this register bit.
0	GPVPLCD	General-purpose output control for VPLCD pin. When the LCDGPEN bit is set to 1, the VPLCD pin is driven by the value of this register bit.

Note Hold the value before reset

18.3.24 MISCREGn (0x0B00 0330 to 0x0B00 034E)

Remark n = 0 to 15

MISCREG0 (0x0B00 0330)	MISCREG8 (0x0B00 0340)
MISCREG1 (0x0B00 0332)	MISCREG9 (0x0B00 0342)
MISCREG2 (0x0B00 0334)	MISCREG10 (0x0B00 0344)
MISCREG3 (0x0B00 0336)	MISCREG11 (0x0B00 0346)
MISCREG4 (0x0B00 0338)	MISCREG12 (0x0B00 0348)
MISCREG5 (0x0B00 033A)	MISCREG13 (0x0B00 034A)
MISCREG6 (0x0B00 033C)	MISCREG14 (0x0B00 034C)
MISCREG7 (0x0B00 033E)	MISCREG15 (0x0B00 034E)

Bit	15	14	13	12	11	10	9	8
Name	MISCN15	MISCN14	MISCN13	MISCN12	MISCN11	MISCN10	MISCN9	MISCN8
R/W	R/W	R/W	R/W	R/W	R/W	R/W	R/W	R/W
RTCST	0	0	0	0	0	0	0	0
Other resets	Note	Note	Note	Note	Note	Note	Note	Note

Bit	7	6	5	4	3	2	1	0
Name	MISCN7	MISCN6	MISCN5	MISCN4	MISCN3	MISCN2	MISCN1	MISCN0
R/W	R/W	R/W	R/W	R/W	R/W	R/W	R/W	R/W
RTCST	0	0	0	0	0	0	0	0
Other resets	Note	Note	Note	Note	Note	Note	Note	Note

Bit	Name	Function
15 to 0	MISCN(15:0)	Miscellaneous data

Note Hold the value before reset

Remark n = 0 to 15

These registers are battery-backed, and its contents retain even in Hibernate mode.

[MEMO]

CHAPTER 19 TOUCH PANEL INTERFACE UNIT (PIU)

This chapter describes the PIU's operations and register settings.

19.1 General

The PIU uses an on-chip A/D converter and detects the X and Y coordinates of pen contact locations on the touch panel and scans the general-purpose A/D input port. Since the touch panel control circuit and the A/D converter (conversion precision: 10 bits) are both on-chip, the touch panel is connected directly to the V_{R4181}.

The PIU's function, namely the detection of X and Y coordinates, is performed partly by hardware and partly by software.

Hardware tasks :

- Touch panel applied voltage control
- Reception of coordinate data

Software task : • Processing of coordinate data based on data sampled by hardware

Features of the PIU's hardware tasks are described below.

- Can be directly connected to touch panel with four-pin resistance layers (on-chip touch panel driver)
- Interface for on-chip A/D converter
- Voltage detection at three general-purpose AD ports and one audio input port
- Operation of A/D converter based on various settings and control of voltage applied to touch panel
- Sampling of X-coordinate and Y-coordinate data
- Variable coordinate data sampling interval
- Interrupt is triggered if pen touch occurs regardless of CPU operation mode (interrupts do not occur when in CPU hibernate mode)
- Four dedicated buffers for up to two pages each of coordinate data
- Four buffers for A/D port scan
- Auto/manual options for coordinate data sampling start/stop control

19.1.1 Block diagrams

Figure 19-1. PIU Peripheral Block Diagram

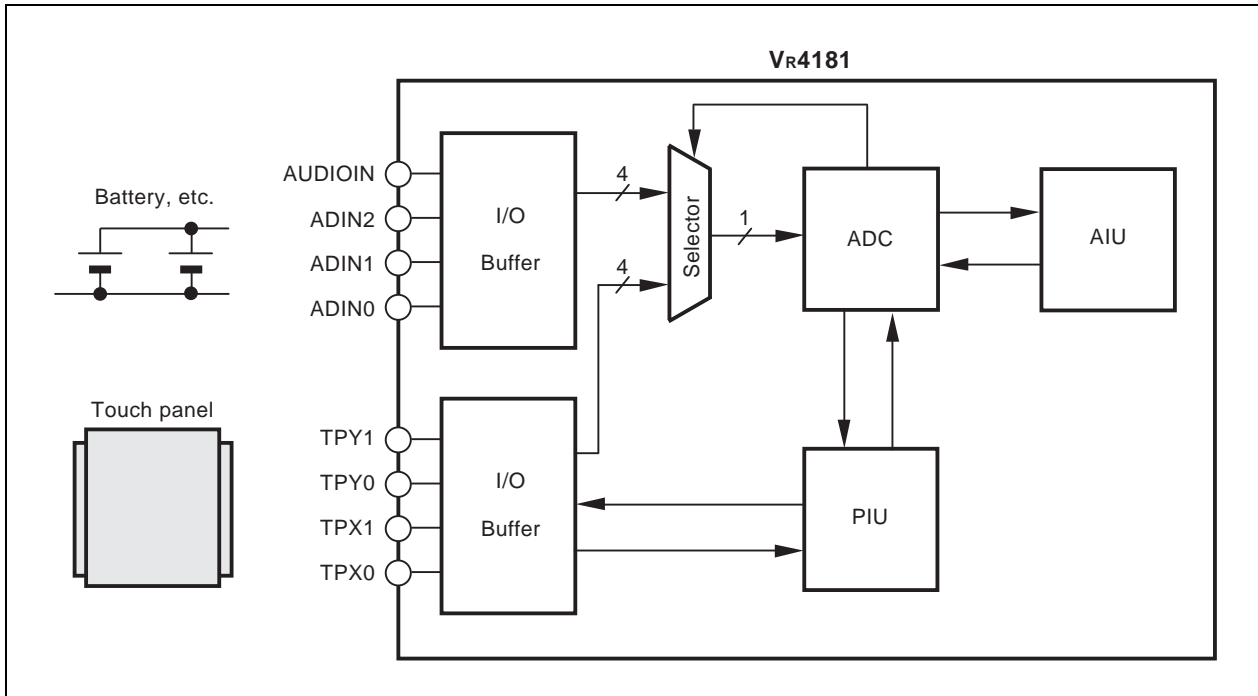

- **Touch panel**

A set of four pins are located at the edges of the X-axis and Y-axis resistance layers, and the two layers have high resistance when there is no pen contact and low resistance when there is pen contact. The resistance between the two edges of the resistance layers is about 1 k Ω . When a voltage is applied to both edges of the Y-axis resistance layer, the voltage (V_{Y1} and V_{Y2} in the figure below) is measured at the X-axis resistance layer's pins to determine the Y coordinate. Similarly, when a voltage is applied to both edges of the X-axis resistance layer, the voltage (V_{X1} and V_{X2} in the figure below) is measured at the Y-axis resistance layer's pins to determine the X coordinate. For greater precision, voltage applied to individual resistance-layer pins can be measured to obtain X and Y coordinate data based on four voltage measurements. The obtained data is stored into the PIUBPnmREG register ($n = 0$ or 1 , $m = 0$ to 3).

Figure 19-2. Coordinate Detection Equivalent Circuits

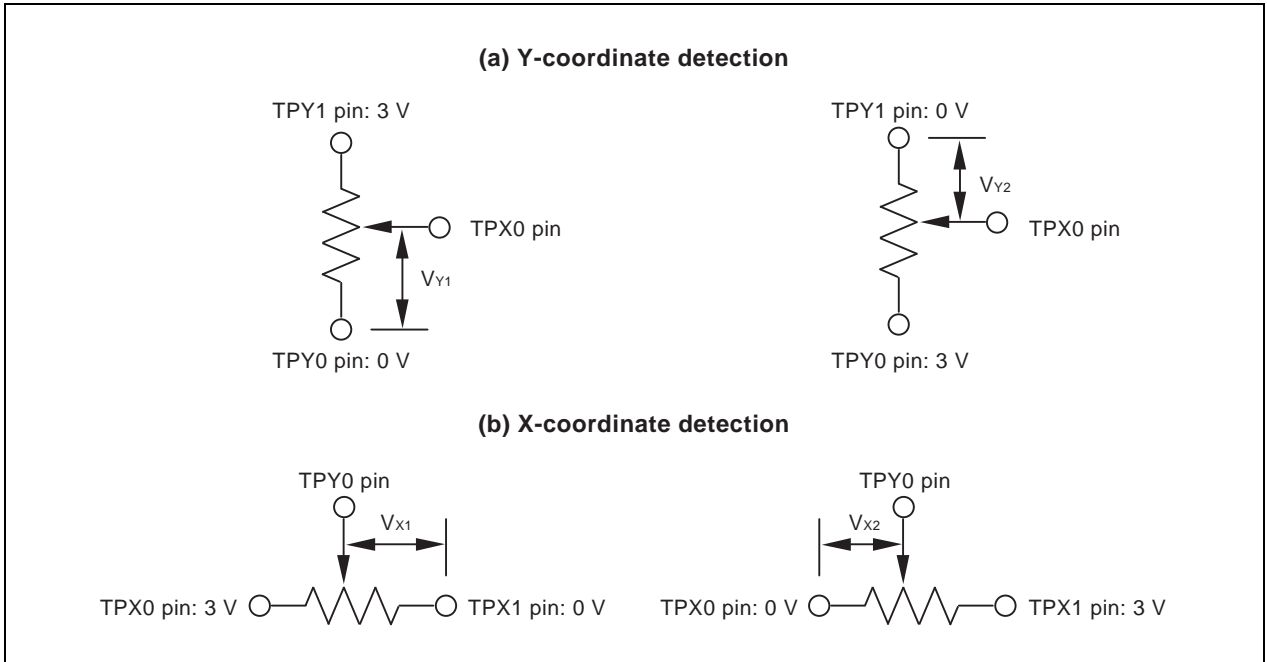
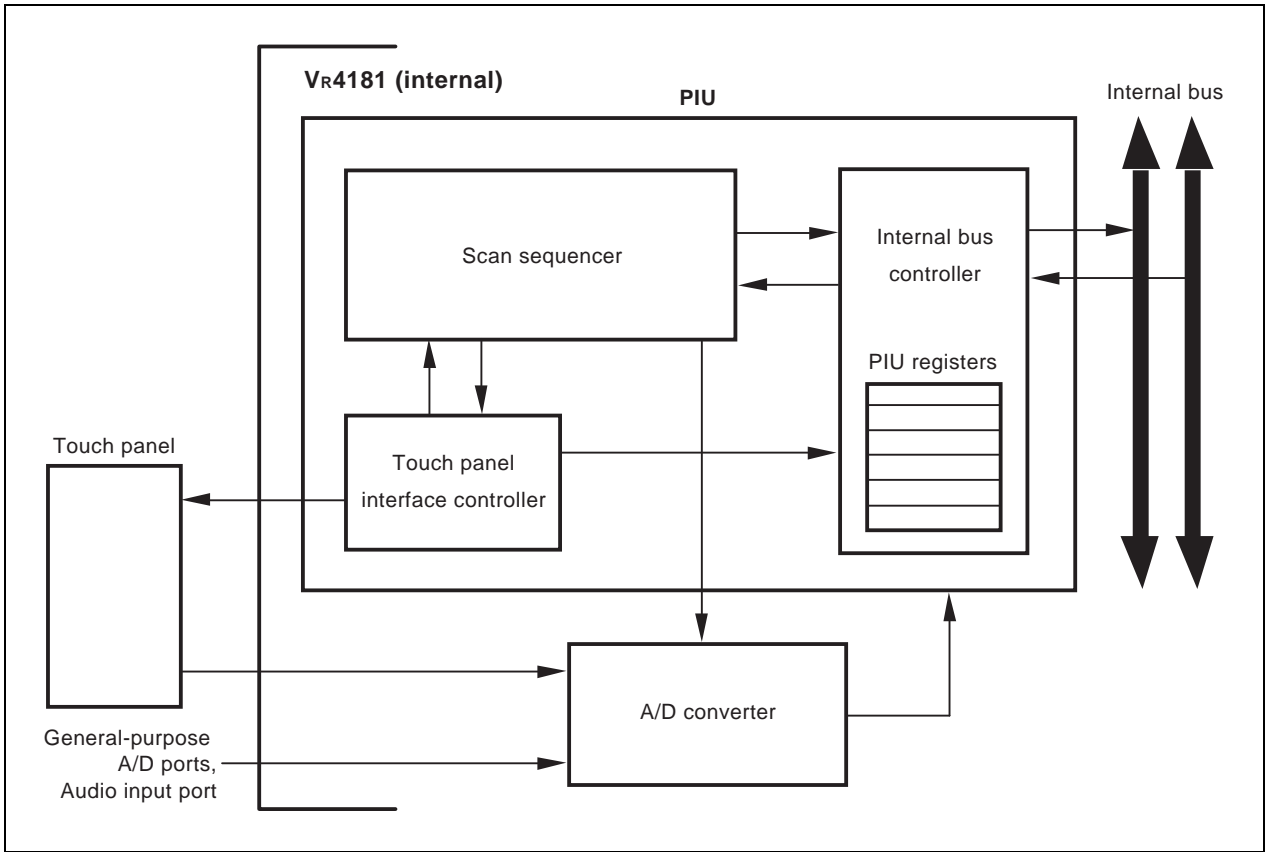

Figure 19-3. Internal Block Diagram of PIU



The PIU includes three blocks: an internal bus controller, a scan sequencer, and a touch panel interface controller.

- Internal bus controller
The internal bus controller controls the internal bus, the PIU registers, and interrupts and performs serial/parallel conversion of data from the A/D converter.
- Scan sequencer
The scan sequencer is used for PIU state management.
- Touch panel interface controller
The touch panel interface controller is used to control the touch panel.

19.2 Scan Sequencer State Transition

Figure 19-4. Scan Sequencer State Transition Diagram

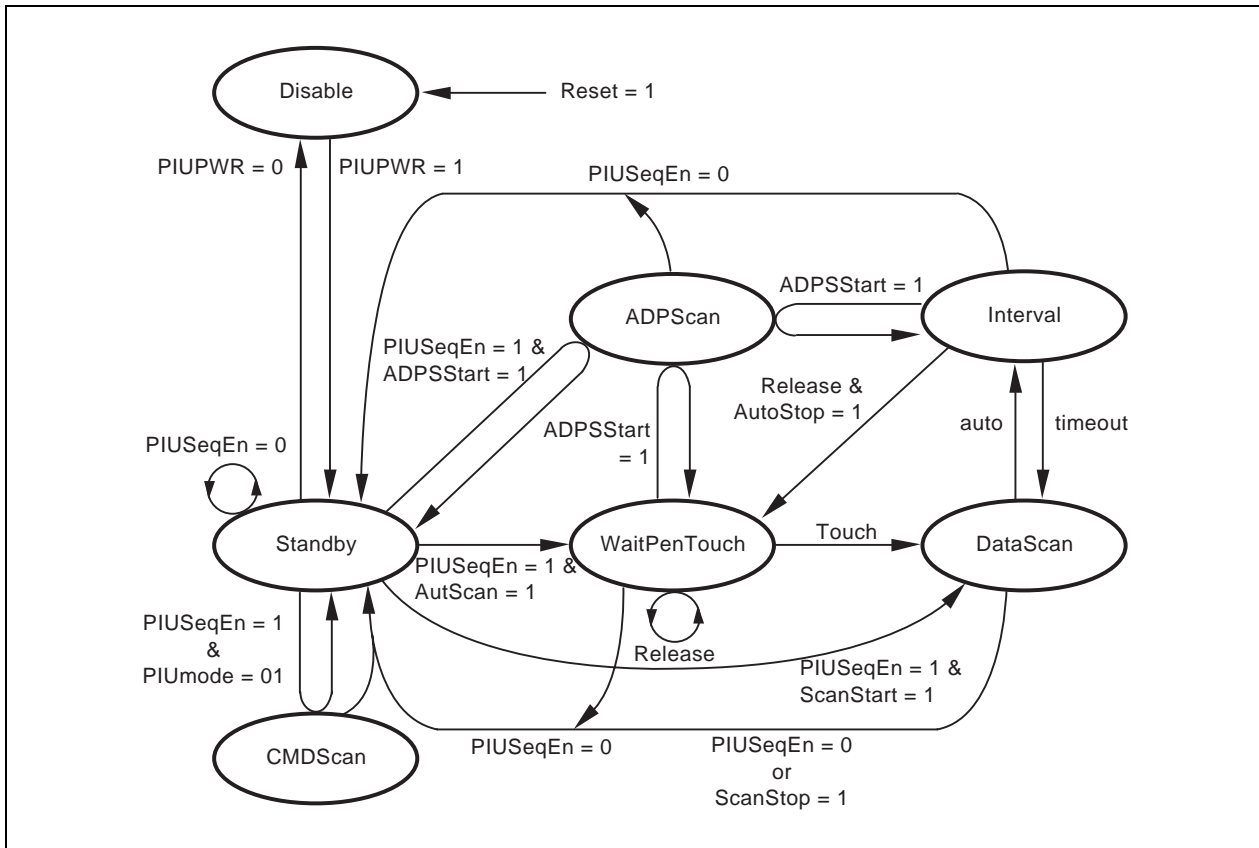

- Disable state

In this state, the A/D converter is in standby mode, the output pins are in touch detection mode (no PIU interrupt), and the input pins are in mask mode (to prevent misoperation when an undefined input is applied).

- Standby state

In this state, the unit is in scan idle mode. The touch panel is in low-power mode (0 V voltage is applied to the touch panel and the A/D converter is in disable mode). Normally, this is the state from which various mode settings are made.

Caution State transitions occur when the PIUSEQEN bit is active, so the PIUSEQEN bit must be set as active after each mode setting has been completed.

- ADPortScan state

This is the state in which voltage is measured at the A/D converter's three general-purpose ports and one audio input port. After the A/D converter is activated and voltage data is obtained, the data is stored in the PIU's internal data buffer (PIUABxREG). After the four ports are scanned, a PadCMDIntr interrupt occurs. After this interrupt occurs, the ADPSSTART bit is automatically set as inactive and the state changes to the state in which the ADPSSTART bit was active.

- CMDScan state

When in this state, the A/D converter operates using various settings. Voltage data from one port only is fetched based on a combination of the touch panel pin setting (TPX[1:0], TPY[1:0]) and the selection of an input port (TPX[1:0], TPY[1:0], AUDIOIN, ADIN[2:0]) to the A/D converter. Use PIUCMDREG to make the touch panel pin setting and to select the input port.

- WaitPenTouch state

This is the standby state that waits for a touch panel "touch" state. When the PIU detects a touch panel "touch" state, PenChgIntr (an internal interrupt in the PIU) occurs. At this point, if the PADATSCAN bit is active, the state changes to the PenDataScan state. During the WaitPenTouch state, it is possible to change to Suspend mode because the panel state can be detected even when TClock has been stopped.

- PenDataScan state

This is the state in which touch panel coordinates are detected. The A/D converter is activated and the four sets of data for each coordinate are sampled.

Caution If one complete pair of coordinates is not obtained during the interval between one pair of coordinates and the next coordinate data, a PadDataLostIntr interrupt occurs.

- IntervalNextScan state

This is the standby state that waits for the next coordinate sampling period and the touch panel's "Release" state. After the touch panel state is detected, the time period specified via PIUSIVLREG elapses before the transition to the PenDataScan state. If the PIU detects the "Release" state within the specified time period, PenChgIntr (an internal interrupt in the PIU) occurs. At this point, the state changes to the WaitPenTouch state if the PADAUTOSTOP bit is active. If the PADATSTOP bit is inactive, it changes to the PenDataScan state after the specified time period has elapsed.

19.3 Register Set

The PIU registers are listed below.

Table 19-1. PIU Registers

Address	R/W	Register symbol	Function
0x0B00 0122	R/W	PIUCNTREG	PIU Control register
0x0B00 0124	R/W	PIUINTREG	PIU Interrupt cause register
0x0B00 0126	R/W	PIUSIVLREG	PIU Data sampling interval register
0x0B00 0128	R/W	PIUSTBLREG	PIU A/D converter start delay register
0x0B00 012A	R/W	PIUCMDREG	PIU A/D command register
0x0B00 0130	R/W	PIUASCNREG	PIU A/D port scan register
0x0B00 0132	R/W	PIUAMSKREG	PIU A/D scan mask register
0x0B00 013E	R	PIUCIVLREG	PIU Check interval register
0x0B00 02A0	R/W	PIUPB00REG	PIU Page 0 Buffer 0 register
0x0B00 02A2	R/W	PIUPB01REG	PIU Page 0 Buffer 1 register
0x0B00 02A4	R/W	PIUPB02REG	PIU Page 0 Buffer 2 register
0x0B00 02A6	R/W	PIUPB03REG	PIU Page 0 Buffer 3 register
0x0B00 02A8	R/W	PIUPB10REG	PIU Page 1 Buffer 0 register
0x0B00 02AA	R/W	PIUPB11REG	PIU Page 1 Buffer 1 register
0x0B00 02AC	R/W	PIUPB12REG	PIU Page 1 Buffer 2 register
0x0B00 02AE	R/W	PIUPB13REG	PIU Page 1 Buffer 3 register
0x0B00 02B0	R/W	PIUAB0REG	PIU A/D scan Buffer 0 register
0x0B00 02B2	R/W	PIUAB1REG	PIU A/D scan Buffer 1 register
0x0B00 02B4	R/W	PIUAB2REG	PIU A/D scan Buffer 2 register
0x0B00 02B6	R/W	PIUAB3REG	PIU A/D scan Buffer 3 register
0x0B00 02BC	R/W	PIUPB04REG	PIU Page 0 Buffer 4 register
0x0B00 02BE	R/W	PIUPB14REG	PIU Page 1 Buffer 4 register

These registers are described in detail below.

State of interrupt requests caused by PIU is indicated and can be set in the following registers, which are included in the ICU (refer to **CHAPTER 14 INTERRUPT CONTROL UNIT (ICU)** for details).

Table 19-2. PIU Interrupt Registers

Address	R/W	Register symbol	Function
0x0B00 0082	R	PIUINTREG	PIU interrupt indication register
0x0B00 008E	R/W	MPIUINTREG	PIU interrupt mask register

19.3.1 PIUCNTREG (0x0B00 0122)

(1/2)

Bit	15	14	13	12	11	10	9	8
Name	Reserved	Reserved	PENSTC	PADSTATE2	PADSTATE1	PADSTATE0	PADATSTOP	PADATSTART
R/W	R	R	R	R	R	R	R/W	R/W
RTCRST	0	0	0	0	0	0	0	0
Other resets	0	0	0	0	0	0	0	0

Bit	7	6	5	4	3	2	1	0
Name	PADSCAN STOP	PADSCAN START	PADSCAN TYPE	PIUMODE1	PIUMODE0	PIUSEQEN	PIUPWR	PADRST
R/W	R/W	R/W	R/W	R/W	R/W	R/W	R/W	W
RTCRST	0	0	0	0	0	0	0	0
Other resets	0	0	0	0	0	0	0	0

Bit	Name	Function
15, 14	Reserved	0 is returned when read
13	PENSTC	Touch/release when touch panel contact state changes 1 : Touch 0 : Release
12, 10	PADSTATE(2:0)	Scan sequencer status 111 : CmdScan 110 : IntervalNextScan 101 : PenDataScan 100 : WaitPenTouch 011 : RFU 010 : ADPortScan 001 : Standby 000 : Disable
9	PADATSTOP	Sequencer auto stop setting during touch panel release state 1 : Auto stop after sampling data for one set of coordinates during release state 0 : No auto stop (even during release state)
8	PADATSTART	Sequencer auto start setting during touch panel touch state 1 : Auto start during touch state 0 : No auto start during touch state
7	PADSCANSTOP	Forced stop setting for touch panel sequencer 1 : Forced stop after sampling data for one set of coordinates 0 : Do not stop

(2/2)

Bit	Name	Function
6	PADSCANSTART	Start setting for touch panel sequencer 1 : Forced start 0 : Do not start
5	PADSCANTYPE	Touch pressure sampling enable 1: Enable 0: Prohibit
4, 3	PIUMODE(1:0)	PIU mode setting 11 : RFU 10 : RFU 01 : Operate A/D converter using any command 00 : Sample coordinate data
2	PIUSEQEN	Scan sequencer operation enable 1 : Enable 0 : Prohibit
1	PIUPWR	PIU power mode setting 1 : Set PIU output as active and change to standby mode 0 : Set panel to touch detection state and set PIU operation stop enabled mode
0	PADRST	PIU reset. Once the PADRST bit is set to "1", it is automatically cleared to 0 after four TClock cycles. 1 : Reset 0 : Normal

This register is used to make various settings for the PIU.

The PENSTC bit indicates the touch panel contact state at the time when the PENCHGINTR bit of PIUINTREG is set to 1. This bit's state remains as it is until PENCHGINTR is cleared to 0. Also, when PENCHGINTR is cleared to 0, PENSTC indicates the touch panel contact state. However, PENSTC does not change while PENCHGINTR is set to 1, even if the touch panel contact state changes between release and touch.

Some bits in this register cannot be set in a specific state of scan sequencer. The combination of the setting of this register and the sequencer state is as follows.

Table 19-3. PIUCNTREG Bit Manipulation and States

PIUCNTREG bit manipulation		Scan sequencer's state			
		Disable	Standby	WaitPenTouch	PenData Scan
PADRST	0 → 1	– ^{Note1}	Disable ^{Note1}	Disable ^{Note1}	Disable ^{Note1}
PIUPWR	0 → 1	Standby	?	×	×
	1 → 0	?	Disable	×	×
PIUSEQEN	0 → 1	×	WaitPenTouch	?	?
	1 → 0	?	?	Standby	Standby
PADATSTART	0 → 1	×	–	PenDataScan ^{Note2}	×
	1 → 0	×	–	–	×
PADATSTOP	0 → 1	×	–	×	×
	1 → 0	×	–	×	×
PADSCANSTART	0 → 1	×	PenDataScan ^{Note3}	×	×
	1 → 0	×	–	×	×
PADSCANSTOP	0 → 1	×	–	×	Standby ^{Note4}
	1 → 0	×	–	×	–

PIUCNTREG bit manipulation		Scan sequencer's state		
		IntervalNextScan	ADPortScan	CmdScan
PADRST	0 → 1	Disable ^{Note1}	Disable ^{Note1}	Disable ^{Note1}
PIUPWR	0 → 1	?	?	?
	1 → 0	×	×	×
PIUSEQEN	0 → 1	?	?	?
	1 → 0	Standby	Standby	Standby
PADATSTART	0 → 1	×	×	×
	1 → 0	×	×	×
PADATSTOP	0 → 1	×	×	×
	1 → 0	×	×	×
PADSCANSTART	0 → 1	×	×	×
	1 → 0	×	×	×
PADSCANSTOP	0 → 1	Standby	Standby ^{Note4}	Standby ^{Note4}
	1 → 0	?	–	–

Notes 1. After “1” is written, the bit is automatically cleared to 0 after four TClock cycles.

2. State transition occurs during touch state

3. State transition occurs when PIUSEQEN = 1

4. State transition occurs after one set of data is sampled. This bit is cleared to 0 after the state transition occurs.

Remarks – : The bit change is retained but there is no state transition.

× : Setting prohibited (operation not guaranteed)

? : Combination of state and bit status before setting does not exist

19.3.2 PIUINTREG (0x0B00 0124)

Bit	15	14	13	12	11	10	9	8
Name	OVP	Reserved	Reserved	Reserved	Reserved	Reserved	Reserved	Reserved
R/W	R/W	R	R	R	R	R	R	R
RTCRST	0	0	0	0	0	0	0	0
Other resets	0	0	0	0	0	0	0	0

Bit	7	6	5	4	3	2	1	0
Name	Reserved	PADCMD INTR	PADADP INTR	PADPAGE1 INTER	PADPAGE0 INTER	PADDLOST INTR	Reserved	PENCHG INTR
R/W	R	R/W	R/W	R/W	R/W	R/W	R	R/W
RTCRST	0	0	0	0	0	0	0	0
Other resets	0	0	0	0	0	0	0	0

Bit	Name	Function
15	OVP	Valid page ID bit (older valid page) 1 : Valid data older than page 1 buffer data is retained 0 : Valid data older than page 0 buffer data is retained
14 to 7	Reserved	0 is returned when read
6	PADCMDINTR	PIU command scan interrupt. Cleared to 0 when 1 is written. 1 : Indicates that command scan found valid data 0 : Indicates that command scan did not find valid data in buffer
5	PADADPINTR	PIU A/D port scan interrupt . Cleared to 0 when 1 is written. 1 : Indicates that A/D port scan found valid data with "1" value in buffer 0 : Indicates that A/D port scan did not find valid data with "1" value in buffer
4	PADPAGE1INTER	PIU data buffer page 1 interrupt. Cleared to 0 when 1 is written. 1 : Valid data with "1" value is stored in page 1 of data buffer 0 : No valid data with "1" value in page 1 of data buffer
3	PADPAGE0INTER	PIU data buffer page 0 interrupt. Cleared to 0 when 1 is written. 1 : Valid data with "1" value is stored in page 0 of data buffer 0 : No valid data with "1" value in page 0 of data buffer
2	PADDLOSTINTR	A/D data timeout. Cleared to 0 when 1 is written. 1 : Not data with "1" value found within specified time 0 : No timeout
1	Reserved	0 is returned when read
0	PENCHGINTR	Change in touch panel contact state. Cleared to 0 when 1 is written. 1 : Change has occurred 0 : No change

This register sets and indicates the interrupt request generation of PIU.

When the PENCHGINTR bit is set to 1, the PENSTC bit indicates the touch panel contact state (touch or release) when a contact state changes. The PENSTC bit's state remains until PENCHGINTR bit is cleared to 0. Also, when PENCHGINTR is cleared to 0, PENSTC indicates the touch panel contact state. However, PENSTC does not change while PENCHGINTR is set to 1, even if the touch panel contact state changes between release and touch.

Caution In the Hibernate mode, the V_{R4181} retains the touch panel state. Therefore, if the Hibernate mode has been entered while the touch panel is touched, the contact state may be mistakenly recognized as having changed, when the Fullspeed mode returns.

This may result in $PENCHGINTR$ being set to 1, when a touch panel state change interrupt occurs immediately after the Fullspeed mode returns from the Hibernate mode. Similarly, other bits of $PINUINTREG$ may be set to 1 on returning from the Hibernate mode. Therefore, set each bit of $PIUINTREG$ to 1 to clear an interrupt request, immediately after the Fullspeed mode returns from the Hibernate mode.

19.3.3 PIUSIVLREG (0x0B00 0126)

Bit	15	14	13	12	11	10	9	8
Name	Reserved	Reserved	Reserved	Reserved	Reserved	SCANINT VAL10	SCANINT VAL9	SCANINT VAL8
R/W	R	R	R	R	R	R/W	R/W	R/W
RTCRST	0	0	0	0	0	0	0	0
Other resets	0	0	0	0	0	0	0	0

Bit	7	6	5	4	3	2	1	0
Name	SCANINT VAL7	SCANINT VAL6	SCANINT VAL5	SCANINT VAL4	SCANINT VAL3	SCANINT VAL2	SCANINT VAL1	SCANINT VAL0
R/W	R/W	R/W	R/W	R/W	R/W	R/W	R/W	R/W
RTCRST	1	0	1	0	0	1	1	1
Other resets	1	0	1	0	0	1	1	1

Bit	Name	Function
15 to 11	Reserved	0 is returned when read
10 to 0	SCANINTVAL(10:0)	Coordinate data scan sampling interval setting Interval = SCANINTVAL(10:0) x 30 μ s

This register sets the sampling interval for coordinate data sampling.

The sampling interval for one pair of coordinate data is the value set via $SCANINTVAL(10:0)$ multiplied by 30 μ s. Accordingly, the logical range of sampling intervals that can be set in 30- μ s units is from 0 μ s to 60,810 μ s (about 60 ms). Actually, if the sampling interval setting is shorter than the time required for obtaining a pair of coordinate data or ADPortScan data, a $PIULostIntr$ interrupt will occur. If $PIULostIntr$ interrupts occur frequently, set a longer interval time.

Figure 19-5. Interval Times and States

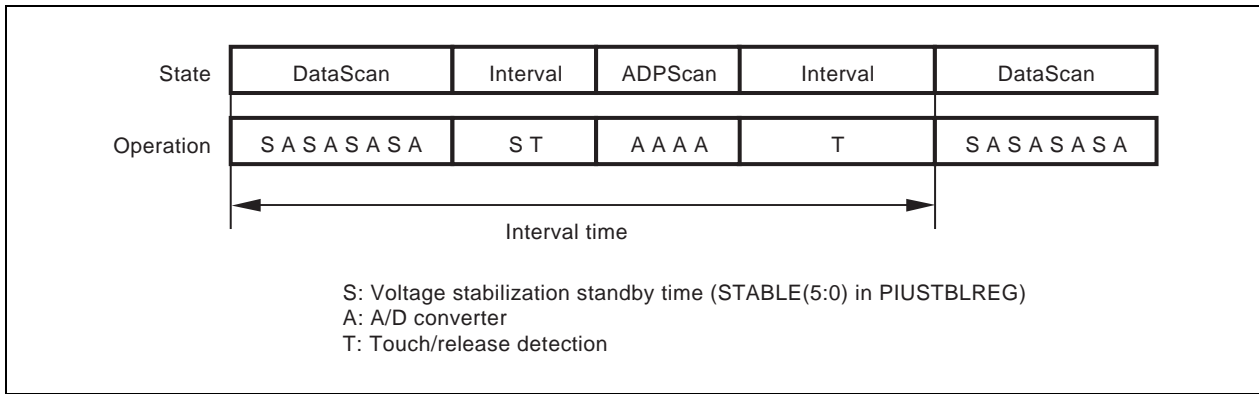

19.3.4 PIUSTBLREG (0x0B00 0128)

Bit	15	14	13	12	11	10	9	8
Name	Reserved	Reserved	Reserved	Reserved	Reserved	Reserved	Reserved	Reserved
R/W	R	R	R	R	R	R	R	R
RTCST	0	0	0	0	0	0	0	0
Other resets	0	0	0	0	0	0	0	0

Bit	7	6	5	4	3	2	1	0
Name	Reserved	Reserved	STABLE5	STABLE4	STABLE3	STABLE2	STABLE1	STABLE0
R/W	R	R	R/W	R/W	R/W	R/W	R/W	R/W
RTCST	0	0	0	0	0	1	1	1
Other resets	0	0	0	0	0	1	1	1

Bit	Name	Function
15 to 6	Reserved	0 is returned when read
5 to 0	STABLE(5:0)	Panel applied voltage stabilization standby time (DataScan, CmdScan state) A/D scan timeout time (ADPScan state) Standby time = STABLE(5:0) × 30 μs (Disable, WaitPenTouch, Interval state) During A/D scan, this can be used as a timeout counter.

The voltage stabilization standby time for the voltage applied to the touch panel can be set via STABLE(5:0) in 30-μs units between 0 μs and 1,890 μs.

19.3.5 PIUCMDREG (0x0B00 012A)

(1/2)

Bit	15	14	13	12	11	10	9	8
Name	Reserved	Reserved	Reserved	STABLEON	TPYEN1	TPYEN0	TPXEN1	TPXEN0
R/W	R	R	R	R/W	R/W	R/W	R/W	R/W
RTCRST	0	0	0	0	0	0	0	0
Other resets	0	0	0	0	0	0	0	0

Bit	7	6	5	4	3	2	1	0
Name	TPYD1	TPYD0	TPXD1	TPXD0	ADCMD3	ADCMD2	ADCMD1	ADCMD0
R/W	R/W	R/W	R/W	R/W	R/W	R/W	R/W	R/W
RTCRST	0	0	0	0	1	1	1	1
Other resets	0	0	0	0	1	1	1	1

Bit	Name	Function
15 to 13	Reserved	0 is returned when read
12	STABLEON	Touch panel applied voltage stabilization time set during command scan (STABLE(5:0) of PIUSTBLREG) enable 1 : Retain panel voltage stabilization time 0 : Ignore panel voltage stabilization time (voltage stabilization standby time = 0)
11, 10	TPYEN(1:0)	TPY port input/output switching during command scan 00 : TPY1 input, TPY0 input 01 : TPY1 input, TPY0 output 10 : TPY1 output, TPY0 input 11 : TPY1 output, TPY0 output
9, 8	TPXEN(1:0)	TPX port input/output switching during command scan 00 : TPX1 input, TPX0 input 01 : TPX1 input, TPX0 output 10 : TPX1 output, TPX0 input 11 : TPX1 output, TPX0 output
7, 6	TPYD(1:0)	TPY output level during command scan 00 : TPY1 = "L", TPY0 = "L" 01 : TPY1 = "L", TPY0 = "H" 10 : TPY1 = "H", TPY0 = "L" 11 : TPY1 = "H", TPY0 = "H" TPYD value is ignored when TPYEN is set for input.
5, 4	TPXD(1:0)	TPX output level during command scan 00 : TPX1 = "L", TPX0 = "L" 01 : TPX1 = "L", TPX0 = "H" 10 : TPX1 = "H", TPX0 = "L" 11 : TPX1 = "H", TPX0 = "H" TPXD value is ignored when TPXEN is set for input.

(2/2)

Bit	Name	Function
3 to 0	ADCMD(3:0)	A/D converter input port selection for command scan 1111 : A/D converter standby mode request 1110 : RFU : 1000 : RFU 0111 : AUDIOIN port 0110 : ADIN2 port 0101 : ADIN1 port 0100 : ADIN0 port 0011 : TPY1 port 0010 : TPY0 port 0001 : TPX1 port 0000 : TPX0 port

This register switches input/output and sets output level for each port during a command scanning operation.

19.3.6 PIUASCNREG (0x0B00 0130)

Bit	15	14	13	12	11	10	9	8
Name	Reserved	Reserved	Reserved	Reserved	Reserved	Reserved	Reserved	Reserved
R/W	R	R	R	R	R	R	R	R
RTCRST	0	0	0	0	0	0	0	0
Other resets	0	0	0	0	0	0	0	0

Bit	7	6	5	4	3	2	1	0
Name	Reserved	Reserved	Reserved	Reserved	Reserved	Reserved	TPPSCAN	ADPS START
R/W	R	R	R	R	R	R	R/W	R/W
RTCRST	0	0	0	0	0	0	0	0
Other resets	0	0	0	0	0	0	0	0

Bit	Name	Function
15 to 2	Reserved	0 is returned when read
1	TPPSCAN	Port selection for ADPortScan 1 : Select TPX(1:0), TPY(1:0) (for touch panel) as A/D port 0 : Select ADIN(2:0) (general-purpose) as A/D port and AUDIOIN as audio input port The bit manipulation is valid only in the Standby state. In the other states, the operation is not guaranteed.
0	ADPSSTART	ADPortScan start 1 : Start ADPortScan 0 : Do not perform ADPortScan

This register is used for ADPScan setting

The ADPortScan begins when the ADPSSTART bit is set. After the ADPortScan is completed, the state returns to the state when ADPortScan was started.

If the ADPortScan is not completed within the time period set via PIUSTBLREG's STABLE bits, a PIULostIntr interrupt occurs as a timeout interrupt.

Some bits in this register cannot be set in a specific state of scan sequencer. The combination of the setting of this register and the sequencer state is as follows.

Table 19-4. PIUASCNREG Bit Manipulation and States

PIUASCNREG bit manipulation		Scan sequencer's state			
		Disable	Standby	WaitPenTouch	PenData Scan
ADPSSTART	0 → 1	×	ADPortScan ^{Note}	×	×
	1 → 0	×	Disable	×	×
TPPSCAN	0 → 1	–	–	–	–
	1 → 0	–	–	–	–

PIUCNTREG bit manipulation		Scan sequencer's state		
		IntervalNextScan	ADPortScan	CmdScan
ADPSSTART	0 → 1	×	ADPortScan ^{Note}	×
	1 → 0	×	Disable	×
TPPSCAN	0 → 1	×	WaitPenTouch	?
	1 → 0	?	?	Standby

Note After ADPortScan is completed, the bit is automatically cleared to 0.

Remark – : The bit change is retained but there is no state transition.
 × : Setting prohibited (operation not guaranteed)
 ? : Combination of state and bit status before setting does not exist

19.3.7 PIUAMSKREG (0x0B00 0132)

Bit	15	14	13	12	11	10	9	8
Name	Reserved	Reserved	Reserved	Reserved	Reserved	Reserved	Reserved	Reserved
R/W	R	R	R	R	R	R	R	R
RTCRST	0	0	0	0	0	0	0	0
Other resets	0	0	0	0	0	0	0	0

Bit	7	6	5	4	3	2	1	0
Name	ADINM3	ADINM2	ADINM1	ADINM0	TPYM1	TPYM0	TPXM1	TPXM0
R/W	R/W	R/W	R/W	R/W	R/W	R/W	R/W	R/W
RTCRST	0	0	0	0	0	0	0	0
Other resets	0	0	0	0	0	0	0	0

Bit	Name	Function
15 to 8	Reserved	0 is returned when read
7	ADINM3	Audio input port mask Valid only during A/D scan. If masked, A/D conversions are not performed for the corresponding port. 1 : Mask 0 : Normal
6 to 4	ADINM(2:0)	General-purpose A/D port mask Valid only during A/D scan. If masked, A/D conversions are not performed for the corresponding port. 1 : Mask 0 : Normal
3, 2	TPYM(1:0)	Touch panel A/D port TPY mask Valid only during A/D scan. If masked, A/D conversions are not performed for the corresponding port. 1 : Mask 0 : Normal
1, 0	TPXM(1:0)	Touch panel A/D port TPX mask Valid only during A/D scan. If masked, A/D conversions are not performed for the corresponding port. 1 : Mask 0 : Normal

This register is used to set masking each A/D port.

19.3.8 PIUCIVLREG (0x0B00 013E)

Bit	15	14	13	12	11	10	9	8
Name	Reserved	Reserved	Reserved	Reserved	Reserved	CHECKIN TVAL10	CHECKIN TVAL9	CHECKIN TVAL8
R/W	R	R	R	R	R	R	R	R
RTCRST	0	0	0	0	0	0	0	0
Other resets	0	0	0	0	0	0	0	0

Bit	7	6	5	4	3	2	1	0
Name	CHECKIN TVAL7	CHECKIN TVAL6	CHECKIN TVAL5	CHECKIN TVAL4	CHECKIN TVAL3	CHECKIN TVAL2	CHECKIN TVAL1	CHECKIN TVAL0
R/W	R	R	R	R	R	R	R	R
RTCRST	1	0	1	0	0	1	1	1
Other resets	1	0	1	0	0	1	1	1

Bit	Name	Function
15 to 11	Reserved	0 is returned when read
10 to 0	CHKINTVAL(10:0)	Interval count value. CHKINTVAL(10:0) = Interval count value

This register is used for real-time reading of internal register values being counted down based on the PIUSIVLREG setting.

19.3.9 PIUPBnmREG (0x0B00 02A0 to 0x0B00 02AE, 0x0B00 02BC to 0x0B00 02BE)

Remark n = 0, 1, m = 0 to 4

PIUPB00REG	(0x0B00 02A0)	PIUPB10REG	(0x0B00 02A8)
PIUPB01REG	(0x0B00 02A2)	PIUPB11REG	(0x0B00 02AA)
PIUPB02REG	(0x0B00 02A4)	PIUPB12REG	(0x0B00 02AC)
PIUPB03REG	(0x0B00 02A6)	PIUPB13REG	(0x0B00 02AE)
PIUPB04REG	(0x0B00 02BC)	PIUPB14REG	(0x0B00 02BE)

Bit	15	14	13	12	11	10	9	8
Name	VALID	Reserved	Reserved	Reserved	Reserved	Reserved	PADDATA9	PADDATA8
R/W	R/W	R	R	R	R	R	R/W	R/W
RTCRST	0	0	0	0	0	0	0	0
Other resets	0	0	0	0	0	0	0	0

Bit	7	6	5	4	3	2	1	0
Name	PADDATA7	PADDATA6	PADDATA5	PADDATA4	PADDATA3	PADDATA2	PADDATA1	PADDATA0
R/W	R/W	R/W	R/W	R/W	R/W	R/W	R/W	R/W
RTCRST	0	0	0	0	0	0	0	0
Other resets	0	0	0	0	0	0	0	0

Bit	Name	Function
15	VALID	Indicates validity of data in PADDATA 1 : Valid 0 : Invalid
14 to 10	Reserved	0 is returned when read
9 to 0	PADDATA(9:0)	A/D converter's sampling data

These registers are used to store coordinate data or touch pressure data. There are four coordinate data buffers and one touch pressure data buffer, each of which holds two pages of coordinate data or pressure data, and the addresses (register addresses) where the coordinate data or the pressure data is stored are fixed. Read coordinate data from the corresponding register in a valid page.

The VALID bit, which indicates when the data is valid, is automatically rendered invalid when the page buffer interrupt source (PIUPAGE0INTR or PIUPAGE1INTR in PIUINTREG) is cleared.

Table 19-4 shows correspondences between the sampled data and the register in which the sampled data is stored.

Table 19-5. Detected Coordinates and Page Buffers

Detected data	Page0 Buffer	Page1 Buffer
X-	PIUPB00REG	PIUPB10REG
X+	PIUPB01REG	PIUPB11REG
Y-	PIUPB02REG	PIUPB12REG
Y+	PIUPB03REG	PIUPB13REG
Z (Touch pressure)	PIUPB04REG	PIUPB14REG

19.3.10 PIUABnREG (0x0B00 02B0 to 0x0B00 02B6)

Remark n = 0 to 3

PIUAB0REG (0x0B00 02B0)
 PIUAB1REG (0x0B00 02B2)
 PIUAB2REG (0x0B00 02B4)
 PIUAB3REG (0x0B00 02B6)

Bit	15	14	13	12	11	10	9	8
Name	VALID	Reserved	Reserved	Reserved	Reserved	Reserved	PADDATA9	PADDATA8
R/W	R/W	R	R	R	R	R	R/W	R/W
RTCRST	0	0	0	0	0	0	0	0
Other resets	0	0	0	0	0	0	0	0

Bit	7	6	5	4	3	2	1	0
Name	PADDATA7	PADDATA6	PADDATA5	PADDATA4	PADDATA3	PADDATA2	PADDATA1	PADDATA0
R/W	R/W	R/W	R/W	R/W	R/W	R/W	R/W	R/W
RTCRST	0	0	0	0	0	0	0	0
Other resets	0	0	0	0	0	0	0	0

Bit	Name	Function
15	VALID	Indicates validity of data in PADDATA 1 : Valid 0 : Invalid
14 to 10	Reserved	0 is returned when read
9 to 0	PADDATA(9:0)	A/D converter's sampling data

These registers are used to store general-purpose A/D port/audio input port sampling data or command scan data. There are four data buffers and the addresses (register address) where the data is stored are fixed.

The VALID bit, which indicates when the data is valid, is automatically rendered invalid when the page buffer interrupt cause (PIUADPINTR in PIUINTREG) is cleared.

Table 19-5 shows correspondences between the sampled data and the register in which the sampled data is stored.

Table 19-6. A/D Ports and Data Buffers

Register	During ADPortScan		During CMDScan
	TPPScan = 0	TPPScan = 1	
PIUAB0REG	ADIN0	TPX0	CMDScanDATA
PIUAB1REG	ADIN1	TPX1	–
PIUAB2REG	ADIN2	TPY0	–
PIUAB3REG	AUDIOIN	TPY1	–

19.4 Register Setting Flow

Be sure to reset the PIU before operating the scan sequencer. Setting initial values via a reset sets particular values for the sequence interval, etc., that are required.

The following registers require initial settings.

PIUSITVLREG SCANINTVAL(10:0)
 PIUSTBLREG STABLE(3:0)

Interrupt mask cancellation settings are required for registers other than the PIU registers.

Table 19-7. Mask Clear During Scan Sequence Operation

Setting	Unit	Register	Bit	Value
Interrupt mask clear	ICU	MSYSINT1REG	PIUINTR	1
	ICU	MPIUINTREG	bits 6:0	0x7F
Clock mask clear	CMU	CMUCLKMSK	MSKPIU	1

(1) Register setting flow for voltage detection at A/D general-purpose ports and audio input port

Standby, WaitPenTouch, or Interval state

<1> PIUAMSKREG Mask setting for A/D port and audio input port

<2> PIUASCNREG ADPSSTART = 1

↓

ADPortScan state

<3> PIUASCNREG ADPSSTART = 0

↓

Standby, WaitPenTouch, or Interval state

(2) Register setting flow for auto scan coordinate detection

Standby state

<1> PIUCNTREG PIUMODE(1:0) = 00

PADATSCAN = 1

PADATSTOP = 1

<2> PIUCNTREG PIUSEQEN = 1

↓

WaitPenTouch state

(3) Register setting flow for manual scan coordinate detection

Disable state
 <1> PIUCNTREG PIUPWR = 1
 ↓
 Standby state
 <2> PIUCNTREG PIUMODE(1:0) = 00
 PADSCANSTART = 1
 <3> PIUCNTREG PIUSEQEN = 1
 ↓
 PenDataScan state

(4) Register setting flow during Suspend mode transition

Standby, WaitPenTouch, or Interval state
 <1> PIUCNTREG PIUSEQEN = 0
 ↓
 Standby state
 <2> PIUCNTREG PIUPWR = 1
 ↓
 Disable state

(5) Register setting flow when returning from Suspend mode transition

Disable state
 <1> PIUCNTREG PIUPWR = 1
 ↓
 Standby state
 <2> PIUCNTREG PIUMODE(1:0) = 00
 PADATSCAN = 1
 PADATSTOP = 1
 <3> PIUCNTREG PIUSEQEN = 1
 ↓
 WaitPenTouch state
 Touch detected
 ↓
 PenDataScan state

(6) Register setting flow for command scan

Disable state
 <1> PIUCNTREG PIUPWR = 1
 ↓
 Standby state
 <2> PIUCNTREG PIUMODE(1:0) = 01
 <3> PIUCNTREG Set touch panel pins, select input port
 <4> PIUCNTREG PIUSEQEN = 1
 ↓
 CMDScan state

19.5 Relationships among TPX, TPY, ADIN, and AUDIOIN Pins and States

State	PadState(2:0)	TPX(1:0)	TPY(1:0)	ADIN(3:0)
PIU disable (pen status detection)	Disable ^{Note}	HH	D-	---
Low-power standby	Standby	00	00	---
Pen status detection	WaitPenTouch/Interval	HH	D-	---
Voltage detection at general-purpose AD0 port	ADPortScan	00	00	—
Voltage detection at general-purpose AD1 port	ADPortScan	00	00	— —
Voltage detection at general-purpose AD2 port	ADPortScan	00	00	— —
Voltage detection at audio input port	ADPortScan	00	00	---
TPY1=H, TPY0=L, TPX0=samp (X+)	PadDataScan	-	HL	---
TPY1=L, TPY0=H, TPX0=samp (X-)	PadDataScan	-	LH	---
TPX1=H, TPX0=L, TPY0=samp (Y+)	PadDataScan	HL	-	---
TPX1=L, TPX0=H, TPY0=samp (Y-)	PadDataScan	LH	-	---
Touch pressure detection (Z)	PadDataScan	HH	d-	---

Note The states of pins are not guaranteed when the PadState(2:0) that precedes the CPU's Suspend or Hibernate instruction execution is in a state other than the Disable state.

Remarks

- 0 : Low level input
- 1 : High level input
- L : Low level output
- H : High level output
- | : A/D converter input
- D : Touch interrupt input (with a pull-down resistor)
- d : No touch interrupt input (with a pull-down resistor)
- : Don't care
- Z : Hi-Z (high-impedance)

19.6 Timing

19.6.1 Touch/release detection timing

Touch/release detection does not use the A/D converter but instead uses the voltage level of the TPY1 pin to determine the panel's touch/release state. The following figure shows a touch/release detection timing diagram.

Figure 19-6. Touch/Release Detection Timing

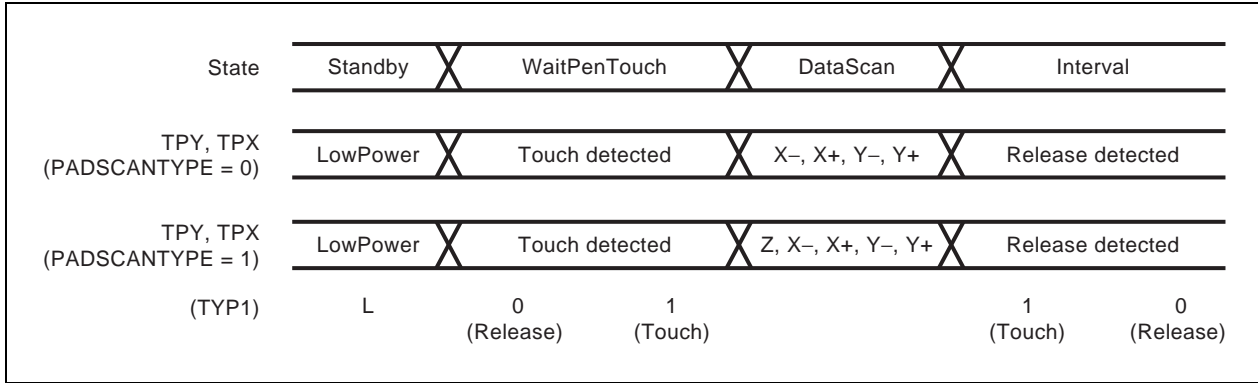

19.6.2 A/D port scan timing

The A/D port scan function sequentially scans the A/D converter's four input channel port pins and stores the data in the data buffer used for A/D port scanning.

The following figure shows an A/D port scan timing diagram.

Figure 19-7. A/D Port Scan Timing

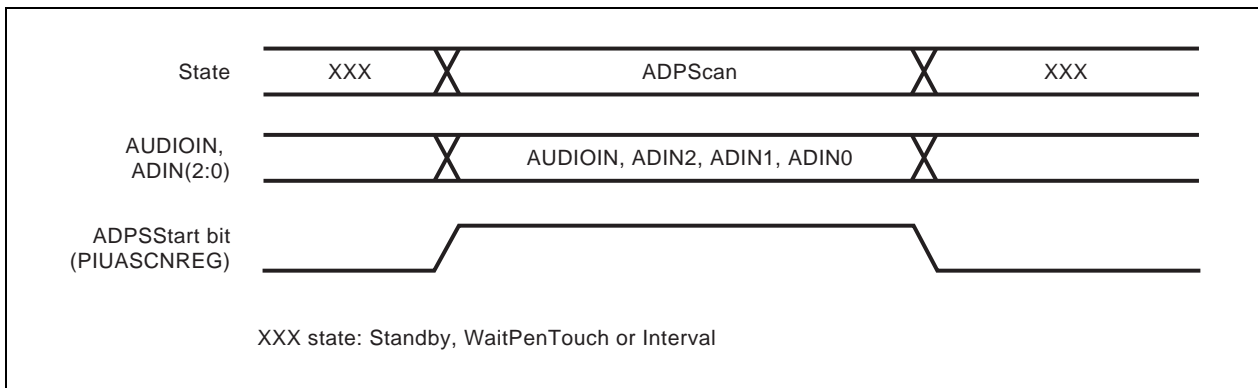

19.7 Data Loss Interrupt Conditions

The PIU issues a PIUDataLostIntr interrupt when any of the following four conditions exist. Once a PIUDataLostIntr interrupt occurs, the sequencer is forcibly changed to the Standby state.

1. Data for one coordinate has not been obtained within the interval period
2. The A/D port scan has not been completed within the time set via PIUSTBLREG
3. Transfer of the next coordinate data has begun while valid data for both pages remains in the buffer
4. The next data transfer starts while there is valid data in the ADPortScan buffer

(1) When data for one coordinate has not been obtained within the interval period

Cause

This condition occurs when the AIU has exclusive use of the A/D converter and the PIU is therefore unable to use the A/D converter.

If this data loss condition occurs frequently, implement a countermeasure that temporarily prohibits the AIU's use of the A/D converter.

Response

After clearing the cause of the PIUDataLostIntr interrupt, set PIUCIUCNTREG's PADATSTART bit or PADSCANSTART bit to restart the coordinate detection operation. Once the PIUDataLostIntr interrupt is cleared, the page in which the loss occurred becomes invalid. If the valid data prior to the data loss is needed, be sure to save the data that is being stored in the page buffer before clearing the PIUDataLostIntr interrupt.

(2) When the A/D port scan has not been completed within the time set via PIUSTBLREG

Cause

Same as cause of condition 1

Response

After clearing the cause of the PIUDataLostIntr interrupt, set PIUASCNREG's ADPSSTART bit to restart the A/D port scan operation. Once the PIUDataLostIntr interrupt is cleared, the page in which the loss occurred becomes invalid. If the valid data prior to the data loss is needed, be sure to save the data that is being stored in the page buffer before clearing the PIUDataLostIntr interrupt.

(3) When transfer of the next coordinate data has begun while valid data for both pages remains in the buffer

Cause

This condition is caused when the data buffer contains two pages of valid data (both the PIUPAGE1INTR and PIUPAGE0INTR interrupts have occurred) but the valid data has not been processed. If the A/D converter is used frequently, this may shorten the time that would normally be required from when both pages become full until when the data loss occurs.

Response

In condition 3, valid data contained in the pages when the PIUDataLostIntr interrupt occurs is never overwritten.

After two pages of valid data are processed, clear the causes of the three interrupts (PIUDataLostIntr, PIUPAGE1INTR, and PIUPAGE0INTR).

After clearing these interrupt causes, set the PADATSTART bit or PADSCANSTART bit of PIUCIUCNTREG to restart the coordinate detection operation.

(4) When the next data transfer starts while there is valid data in the ADPortScan buffer**Cause**

This condition is caused when valid data is not processed even while the ADPortScan buffer holds valid data (PADADPINTR interrupt occurrence).

Response

In condition 4, valid data contained in the buffer when the PIUDataLostIntr interrupt occurs is never overwritten.

After valid data in the buffer is processed, clear the causes of the two interrupts (PIUDataLostIntr, PADADPINTR).

After clearing these interrupt causes, set the ADPSSTART bit of PIUASCNREG to restart the general-purpose A/D port scan.

CHAPTER 20 AUDIO INTERFACE UNIT (AIU)

This chapter describes the AIU's operations and register settings.

20.1 General

The AIU supports speaker output and MIC input operations. The resolution of the D/A converter used for a speaker or microphone is usually 10 bits.

20.2 Register Set

The AIU registers are listed below.

Table 20-1. AIU Registers

Address	R/W	Register symbol	Function
0x0B00 0160	R/W	SDMADATREG	Speaker DMA data register
0x0B00 0162	R/W	MDMADATREG	Microphone DMA data register
0x0B00 0164	R/W	DAVREF_SETUP	D/A converter Vref setup register
0x0B00 0166	R/W	SODATREG	Speaker output data register
0x0B00 0168	R/W	SCNTREG	Speaker output control register
0x0B00 016E	R/W	SCNVC_END	Speaker sample rate control register
0x0B00 0170	R/W	MIDATREG	Microphone input data register
0x0B00 0172	R/W	MCNTREG	Microphone input control register
0x0B00 0178	R/W	DVALIDREG	Data valid register
0x0B00 017A	R/W	SEQREG	Sequential register
0x0B00 017C	R/W	INTREG	Interrupt register
0x0B00 017E	R/W	MCNVC_END	Microphone sample rate control register

These registers are described in detail below.

State of interrupt requests caused by AIU is indicated and can be set in the following registers, which are included in the ICU (refer to **CHAPTER 14 INTERRUPT CONTROL UNIT (ICU)** for details).

Table 20-2. AIU Interrupt Registers

Address	R/W	Register symbol	Function
0x0B00 0084	R	AIUINTREG	AIU interrupt indication register
0x0B00 0090	R/W	MAIUINTREG	AIU interrupt mask register

20.2.1 MDMADATREG (0x0B00 0160)

Bit	15	14	13	12	11	10	9	8
Name	Reserved	Reserved	Reserved	Reserved	Reserved	Reserved	MDMA9	MDMA8
R/W	R	R	R	R	R	R	R/W	R/W
RTCRST	0	0	0	0	0	0	1	0
Other resets	0	0	0	0	0	0	1	0

Bit	7	6	5	4	3	2	1	0
Name	MDMA7	MDMA6	MDMA5	MDMA4	MDMA3	MDMA2	MDMA1	MDMA0
R/W	R/W	R/W	R/W	R/W	R/W	R/W	R/W	R/W
RTCRST	0	0	0	0	0	0	0	0
Other resets	0	0	0	0	0	0	0	0

Bit	Name	Function
15 to 10	Reserved	0 is returned when read
9 to 0	MDMA(9:0)	Microphone input DMA data (from MIDATREG to buffer)

This register is used prior to DMA transfer to store 10-bit data that has been converted by the A/D converter and stored in MIDATREG register. Write is used for debugging and is enabled when AIUMEN bit of SEQREG register is set to 1. This register is cleared (0x0200) by resetting AIUMEN bit of SEQREG register to 0. Therefore, if the AIUMEN bit is set to 0 during DMA transfer, invalid data may be transferred.

20.2.2 SDMATATREG (0x0B00 0162)

Bit	15	14	13	12	11	10	9	8
Name	Reserved	Reserved	Reserved	Reserved	Reserved	Reserved	SDMA9	SDMA8
R/W	R	R	R	R	R	R	R/W	R/W
RTCRST	0	0	0	0	0	0	1	0
Other resets	0	0	0	0	0	0	1	0

Bit	7	6	5	4	3	2	1	0
Name	SDMA7	SDMA6	SDMA5	SDMA4	SDMA3	SDMA2	SDMA1	SDMA0
R/W	R/W	R/W	R/W	R/W	R/W	R/W	R/W	R/W
RTCRST	0	0	0	0	0	0	0	0
Other resets	0	0	0	0	0	0	0	0

Bit	Name	Function
15 to 10	Reserved	0 is returned when read
9 to 0	SDMA(9:0)	Speaker output DMA data (from buffer to SODATREG)

This register is used to store 10-bit DMA data for speaker output. When SODATREG register is empty, the data is transferred to SODATREG register. Write is used for debugging and is enabled when AIUSEN bit of SEQREG register is set to 1. This register is cleared (0x0200) by resetting AIUSEN bit of SEQREG register to 0.

20.2.3 DAVREF_SETUP (0x0B00 0164)

Bit	15	14	13	12	11	10	9	8
Name	DAVREF15	DAVREF14	DAVREF13	DAVREF12	DAVREF11	DAVREF10	DAVREF9	DAVREF8
R/W	R/W	R/W	R/W	R/W	R/W	R/W	R/W	R/W
RTCRST	0	0	0	0	0	0	0	0
Other resets	0	0	0	0	0	0	0	0

Bit	7	6	5	4	3	2	1	0
Name	DAVREF7	DAVREF6	DAVREF5	DAVREF4	DAVREF3	DAVREF2	DAVREF1	DAVREF0
R/W	R/W	R/W	R/W	R/W	R/W	R/W	R/W	R/W
RTCRST	0	1	1	1	1	1	0	1
Other resets	0	1	1	1	1	1	0	1

Bit	Name	Function
15 to 0	DAVREF(15:0)	D/A converter Vref setup time. The following expression is used to calculate the value set to this register. $DAVREF(15:0) = 5 \mu s \times PCLK \text{ frequency}$

This register is used to select a Vref setup time for the D/A converter.

Set to this register a value that selects 5 μs as the Vref setup time. For example, if the internal peripheral clock (PCLK) frequency is 25 MHz, DAVREF(15:0) bits should be set to as follows;

$$DAVREF(15:0) = 5 \times 10^{-6} \times 25 \times 10^6 = 0x007D$$

20.2.4 SODATREG (0x0B00 0166)

Bit	15	14	13	12	11	10	9	8
Name	Reserved	Reserved	Reserved	Reserved	Reserved	Reserved	SODAT9	SODAT8
R/W	R	R	R	R	R	R	R/W	R/W
RTCRST	0	0	0	0	0	0	1	0
Other resets	0	0	0	0	0	0	1	0

Bit	7	6	5	4	3	2	1	0
Name	SODAT7	SODAT6	SODAT5	SODAT4	SODAT3	SODAT2	SODAT1	SODAT0
R/W	R/W	R/W	R/W	R/W	R/W	R/W	R/W	R/W
RTCRST	0	0	0	0	0	0	0	0
Other resets	0	0	0	0	0	0	0	0

Bit	Name	Function
15 to 10	Reserved	0 is returned when read
9 to 0	SODAT(9:0)	Speaker output data (from SDMADATREG to D/A converter)

This register is used to store 10-bit DMA data for speaker output. Data is received from the D/A converter and is sent to SDMADATREG register. Write is used for debugging and is enabled when AIUSEN bit of SEQREG register is set to 1. This register is cleared (0x0200) by resetting AIUSEN bit of SEQREG register to 0.

20.2.5 SCNTREG (0x0B00 0168)

Bit	15	14	13	12	11	10	9	8
Name	DAENAIU	Reserved	Reserved	Reserved	Reserved	Reserved	Reserved	Reserved
R/W	R/W	R	R	R	R	R	R	R
RTCRST	0	0	0	0	0	0	0	0
Other resets	0	0	0	0	0	0	0	0

Bit	7	6	5	4	3	2	1	0
Name	Reserved	Reserved	Reserved	Reserved	SSTATE	Reserved	SSTOPEN	Reserved
R/W	R	R	R	R	R	R	R/W	R
RTCRST	0	0	0	0	0	0	0	0
Other resets	0	0	0	0	0	0	0	0

Bit	Name	Function
15	DAENAIU	This is the speaker D/A enable bit. 1 : Vref ON 0 : Vref OFF
14 to 4	Reserved	0 is returned when read
3	SSTATE	Indicates speaker operation state 1 : In operation 0 : Stopped
2	Reserved	0 is returned when read
1	SSTOPEN	Speaker output DMA transfer 1-page boundary interrupt stop 1 : Stop DMA request at 1-page boundary 0 : Stop DMA request at 2-page boundary
0	Reserved	0 is returned when read

This register is used to control the AIU's speaker block.

The DAENAIU bit controls the connection of DVDD and Vref input to ladder type resistors in the D/A converter. Setting this bit to 0 (OFF) allows low power consumption when not using the D/A converter. When using the D/A converter, this bit must be set following the sequence described in **20.3 Operation Sequence**.

The content of the SSTATE bit is valid only when the AIUSEN bit of SEQREG register is set to 1.

20.2.6 SCNVC_END (0x0B00 016E)

Bit	15	14	13	12	11	10	9	8
Name	SCNVC15	SCNVC14	SCNVC13	SCNVC12	SCNVC11	SCNVC10	SCNVC9	SCNVC8
R/W	R/W	R/W	R/W	R/W	R/W	R/W	R/W	R/W
RTCRST	0	0	0	0	0	1	0	0
Other resets	0	0	0	0	0	1	0	0

Bit	7	6	5	4	3	2	1	0
Name	SCNVC7	SCNVC6	SCNVC5	SCNVC4	SCNVC3	SCNVC2	SCNVC1	SCNVC0
R/W	R/W	R/W	R/W	R/W	R/W	R/W	R/W	R/W
RTCRST	1	1	1	1	1	1	0	0
Other resets	1	1	1	1	1	1	0	0

Bit	Name	Function
15 to 0	SCNVC(15:0)	Speaker sample rate control. The following expression is used to calculate the value set to this register. $SCNVC(15:0) = PCLK \text{ frequency} / \text{sample rate}$

This register is used to select a conversion rate for the D/A converter.

For example, if the desired conversion rate is 8 kHz and internal peripheral clock (PCLK) frequency is 25 MHz, SCNVC(15:0) bits should be set to as follows;

$$SCNVC(15:0) = 25 \times 10^6 / 8 \times 10^3 = 0x0C35$$

20.2.7 MIDATREG (0x0B00 0170)

Bit	15	14	13	12	11	10	9	8
Name	Reserved	Reserved	Reserved	Reserved	Reserved	Reserved	MIDAT9	MIDAT8
R/W	R	R	R	R	R	R	R/W	R/W
RTCRST	0	0	0	0	0	0	1	0
Other resets	0	0	0	0	0	0	1	0

Bit	7	6	5	4	3	2	1	0
Name	MIDAT7	MIDAT6	MIDAT5	MIDAT4	MIDAT3	MIDAT2	MIDAT1	MIDAT0
R/W	R/W	R/W	R/W	R/W	R/W	R/W	R/W	R/W
RTCRST	0	0	0	0	0	0	0	0
Other resets	0	0	0	0	0	0	0	0

Bit	Name	Function
15 to 10	Reserved	0 is returned when read
9 to 0	MIDAT(9:0)	Microphone input data (from A/D to MDMADATREG)

This register is used to store 10-bit speaker input data that has been converted by the A/D converter. Data is sent to MDMADATREG register and is received from the A/D converter. Write is used for debugging and is enabled when AIUMEN bit of SEQREG register is set to 1. This register is cleared (0x0200) by resetting AIUMEN bit of SEQREG register to 0.

20.2.8 MCNTREG (0x0B00 0172)

Bit	15	14	13	12	11	10	9	8
Name	ADENAIU	Reserved	Reserved	Reserved	Reserved	Reserved	Reserved	Reserved
R/W	R/W	R	R	R	R	R	R	R
RTCRST	0	0	0	0	0	0	0	0
Other resets	0	0	0	0	0	0	0	0

Bit	7	6	5	4	3	2	1	0
Name	Reserved	Reserved	Reserved	Reserved	MSTATE	Reserved	MSTOPEN	ADREQAIU
R/W	R	R	R	R	R	R	R/W	R
RTCRST	0	0	0	0	0	0	0	0
Other resets	0	0	0	0	0	0	0	0

Bit	Name	Function
15	ADENAIU	This is the microphone A/D enable bit. 1 : Vref ON 0 : Vref OFF
14 to 4	Reserved	0 is returned when read
3	MSTATE	Indicates microphone operation state (= AIUMEN) 1 : In operation 0 : Stopped
2	Reserved	0 is returned when read
1	MSTOPEN	Microphone input DMA transfer 1-page boundary interrupt stop 1 : Stop DMA request at 1-page boundary 0 : Stop DMA request at 2-page boundary
0	ADREQAIU	A/D use request bit 1 : Request 0 : Normal

This register is used to control the AIU's microphone block.

The ADENAIU bit controls the connection of AVDD and Vref input to ladder type resistors in the A/D converter. Setting this bit to 0 (OFF) allows low power consumption when not using the A/D converter. When using the A/D converter, this bit must be set following the sequence described in **20.3 Operation Sequence**.

The content of the MSTATE bit is valid only when the AIUMEN bit of SEQREG register is set to 1.

This unit has priority when a conflict occurs with the PIU in relation to A/D conversion requests.

20.2.9 DVALIDREG (0x0B00 0178)

Bit	15	14	13	12	11	10	9	8
Name	Reserved	Reserved	Reserved	Reserved	Reserved	Reserved	Reserved	Reserved
R/W	R	R	R	R	R	R	R	R
RTCRST	0	0	0	0	0	0	0	0
Other resets	0	0	0	0	0	0	0	0

Bit	7	6	5	4	3	2	1	0
Name	Reserved	Reserved	Reserved	Reserved	SODATV	SDMAV	MIDATV	MDMAV
R/W	R	R	R	R	R/W	R/W	R/W	R/W
RTCRST	0	0	0	0	0	0	0	0
Other resets	0	0	0	0	0	0	0	0

Bit	Name	Function
15 to 4	Reserved	0 is returned when read
3	SODATV	This indicates when valid data has been stored in SODATREG. 1 : Valid data exists 0 : No valid data
2	SDMAV	This indicates when valid data has been stored in SDMADATREG. 1 : Valid data exists 0 : No valid data
1	MIDATV	This indicates when valid data has been stored in MIDATREG. 1 : Valid data exists 0 : No valid data
0	MDMAV	This indicates when valid data has been stored in MDMADATREG. 1 : Valid data exists 0 : No valid data

This register indicates when valid data has been stored in SODATREG, SDMADATREG, MIDATREG, or MDMADATREG register.

If data has been written directly to SODATREG, SDMADATREG, MIDATREG, or MDMADATREG register via software, the bits in this register are not active, so write "1" via software.

Write is used for debugging and is enabled when AIUSEN or AIUMEN bit of SEQREG register is set to 1.

If AIUSEN bit = 0 or AIUMEN bit = 0 in SEQREG register, then SODATV bit = SDMAV bit = 0 or MIDATV bit = MDMAV bit = 0.

20.2.10 SEQREG (0x0B00 017A)

Bit	15	14	13	12	11	10	9	8
Name	AIURST	Reserved	Reserved	Reserved	Reserved	Reserved	Reserved	Reserved
R/W	R/W	R	R	R	R	R	R	R
RTCRST	0	0	0	0	0	0	0	0
Other resets	0	0	0	0	0	0	0	0

Bit	7	6	5	4	3	2	1	0
Name	Reserved	Reserved	Reserved	AIUMEN	Reserved	Reserved	Reserved	AIUSEN
R/W	R	R	R	R/W	R	R	R	R/W
RTCRST	0	0	0	0	0	0	0	0
Other resets	0	0	0	0	0	0	0	0

Bit	Name	Function
15	AIURST	AIU reset via software 1 : Reset 0 : Normal
14 to 5	Reserved	0 is returned when read
4	AIUMEN	MIC block operation enable, DMA enable 1 : Enable operation 0 : Disable operation
3 to 1	Reserved	0 is returned when read
0	AIUSEN	Speaker block operation enable, DMA enable 1 : Enable operation 0 : Disable operation

This register is used to enable/disable the AIU's operation.

20.2.11 INTREG (0x0B00 017C)

Bit	15	14	13	12	11	10	9	8
Name	Reserved	Reserved	Reserved	Reserved	Reserved	Reserved	MIDLEINTR	MSTINTR
R/W	R	R	R	R	R	R	R/W	R/W
RTCRST	0	0	0	0	0	0	0	0
Other resets	0	0	0	0	0	0	0	0

Bit	7	6	5	4	3	2	1	0
Name	Reserved	Reserved	Reserved	Reserved	Reserved	Reserved	SIDLEINTR	Reserved
R/W	R	R	R	R	R	R	R/W	R
RTCRST	0	0	0	0	0	0	0	0
Other resets	0	0	0	0	0	0	0	0

Bit	Name	Function
15 to 10	Reserved	0 is returned when read
9	MIDLEINTR	MIC idle interrupt (receive data loss). Cleared to 0 when 1 is written. 1 : Occurred 0 : Normal
8	MSTINTR	MIC receive complete interrupt. Cleared to 0 when 1 is written. 1 : Occurred 0 : Normal
7 to 2	Reserved	0 is returned when read
1	SIDLEINTR	SPEAKER idle interrupt (mute). Cleared to 0 when 1 is written. 1 : Occurred 0 : Normal
0	Reserved	0 is returned when read

When data is received from the A/D converter, MIDLEINTR bit is set if valid data still exists in MIDATREG register (MIDATV bit = 1). In this case, MIDATREG register is overwritten.

MSTINTR is set when data is received in MDMADATREG register.

When data is passed to the D/A converter, SIDLEINTR bit is set if there is no valid data in SODATREG register (SODATV bit = 0). However, this interrupt is valid only after AIUSEN bit = 1, after which SODATV bit = 1 in DVALIDREG register.

20.2.12 MCNVC_END (0x0B00 017E)

Bit	15	14	13	12	11	10	9	8
Name	MCNVC15	MCNVC14	MCNVC13	MCNVC12	MCNVC11	MCNVC10	MCNVC9	MCNVC8
R/W	R/W	R/W	R/W	R/W	R/W	R/W	R/W	R/W
RTCRST	0	0	0	0	0	1	0	0
Other resets	0	0	0	0	0	1	0	0

Bit	7	6	5	4	3	2	1	0
Name	MCNVC7	MCNVC6	MCNVC5	MCNVC4	MCNVC3	MCNVC2	MCNVC1	MCNVC0
R/W	R/W	R/W	R/W	R/W	R/W	R/W	R/W	R/W
RTCRST	1	1	1	1	1	1	0	0
Other resets	1	1	1	1	1	1	0	0

Bit	Name	Function
15 to 0	MCNVC(15:0)	Microphone sample rate control. The following expression is used to calculate the value set to this register. $MCNVC(15:0) = PCLK \text{ frequency} / \text{sample rate}$

This register is used to select a conversion rate for the A/D converter.

For example, if the desired conversion rate is 11.025 kHz and internal peripheral clock (PCLK) frequency is 25 MHz, MCNVC(15:0) bits should be set to as follows;

$$MCNVC(15:0) = 25 \times 10^6 / 11.025 \times 10^3 = 0x08DC$$

20.3 Operation Sequence

20.3.1 Output (speaker)

1. Set conversion rate (0x0B00 016E: SCNVC(15:0) = any value)
2. Set D/A converter Vref setup time (0x0B00 0164: DVAREF(15:0) = any value to be 5 μ s)
3. Enable speaker DMA in DCU
4. Set D/A converter's Vref to ON (0x0B00 0168: DAENAIU = 1)
5. Wait for Vref resistor stabilization time (about 5 μ s) (use the RTC counter)

Even if speaker power is set to ON and speaker operation is enabled (AIUSEN = 1) without waiting for Vref resistor stabilization time, speaker output starts after the period calculated with the formula below.

$$5 + 1/\text{conversion rate (44.1, 22.05, 11.025, or 8 ksp/s)} (\mu\text{s})$$

In this case, however, a noise may occur when speaker power is set to ON.

6. Set speaker power ON via GPIO.
7. Speaker operation enable (0x0B00 017A: AIUSEN = 1)

DMA request

Receive acknowledge and DMA data from DMA

0x0B00 0178: SDMAV = SODATV = 1

Output 10-bit data (0x0B00 0166: SODAT) to D/A converter

SODATV = 0, SDMAV = 1

Send SDMADATREG data to SODATREG.

SODATV = 1, SDMAV = 0

Output DMA request and store the data after the next into SDMADATREG.

SODATV = 1, SDMAV = 1

Refresh data at each conversion timing interval (becomes SIDLEINTR = 1 when DMA is slow and SODATV = 0 during conversion timing interval, and (mute) interrupt occurs)

DMA page boundary interrupt occurs at page boundary

Clear the page interrupt request to continue output.

8. Speaker operation to disable (0x0B00 017A: AIUSEN = 0)
9. Set speaker power OFF via GPIO.
10. Set D/A converter's Vref to OFF (0x0B00 0168: AIUDAEN = 0)
11. Disable speaker DMA in DCU

Figure 20-1. Speaker Output and AUDIOOUT Pin

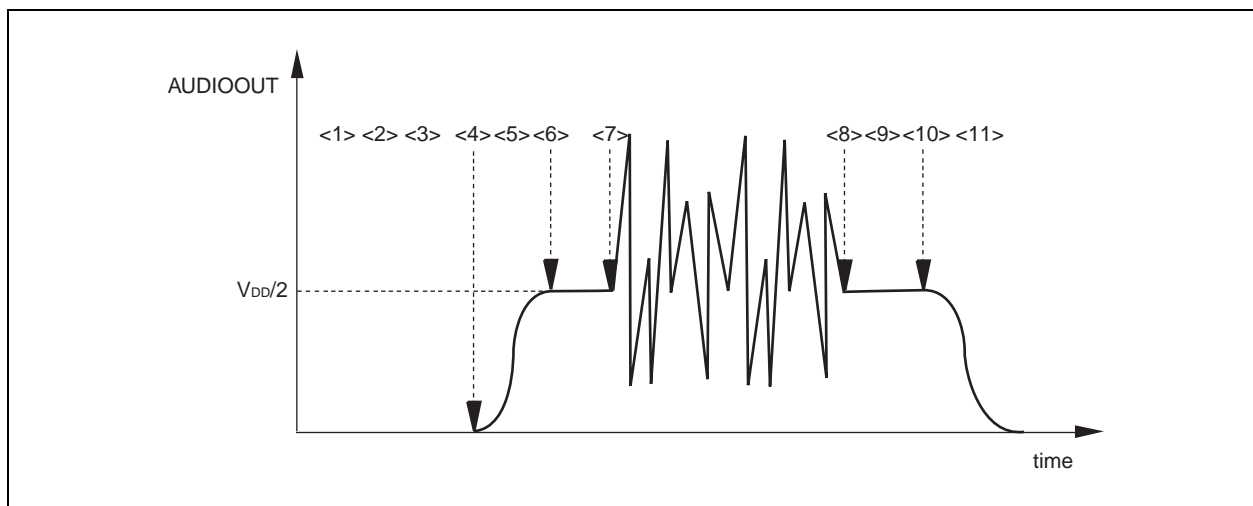

20.3.2 Input (microphone)

1. Set conversion rate (0x0B00 017E: MCNVC(15:0) = any value)
2. Set D/A converter Vref setup time (0x0B00 0164: DVAREF(15:0) = any value to be 5 μ s)
3. Enable microphone DMA in DCU
4. Set A/D converter's Vref to ON (0x0B00 0172: ADENAIU = 1)
 Microphone power can be set ON and microphone operation can be enabled without waiting for Vref resistor stabilization time (about 5 μ s). However, in such a case, sampling starts after the period calculated with the formula below.
 $5 + 1/\text{conversion rate (44.1, 22.05, 11.025, or 8 kspss)} (\mu\text{s})$
5. Set microphone power ON via GPIO.
6. Microphone operation enable (0x0B00 017A: AIUMEN = 1)
 Output A/D request (AIUADREQ) to A/D converter
 Return acknowledge (aiuadack) and 10-bit conversion data from A/D converter.
 Store data in MIDATREG.
 0x0B00 0178: MDMAV = 0, MIDATV = 1
 Transfer data from MIDATREG to MDMADATREG.
 MDMAV = 1, MIDATV = 0
 The INTMST value becomes "1" and an interrupt (receive complete) occurs.
 Issue DMA request and store MIDMADATREG data to memory.
 MDMAV = 0, MIDATV = 0
 An A/D request is issued once per conversion timing interval and 10-bit data is received (becomes MIDDLEINTR = 1 when DMA is slow and MIDATV = 1 during conversion timing interval, and (data loss) interrupt occurs)
 DMA page boundary interrupt occurs at page boundary
 Clear the page interrupt request to continue output.
7. Microphone operation to disable (0x0B00 017A: AIUMEN = 0)
8. Set microphone power OFF via GPIO.
9. Set A/D converter's Vref to OFF (0x0B00 0172: AIUADEN = 0)
10. Disable microphone DMA in DCU

Figure 20-2. AUDIOIN Pin and Microphone Operation

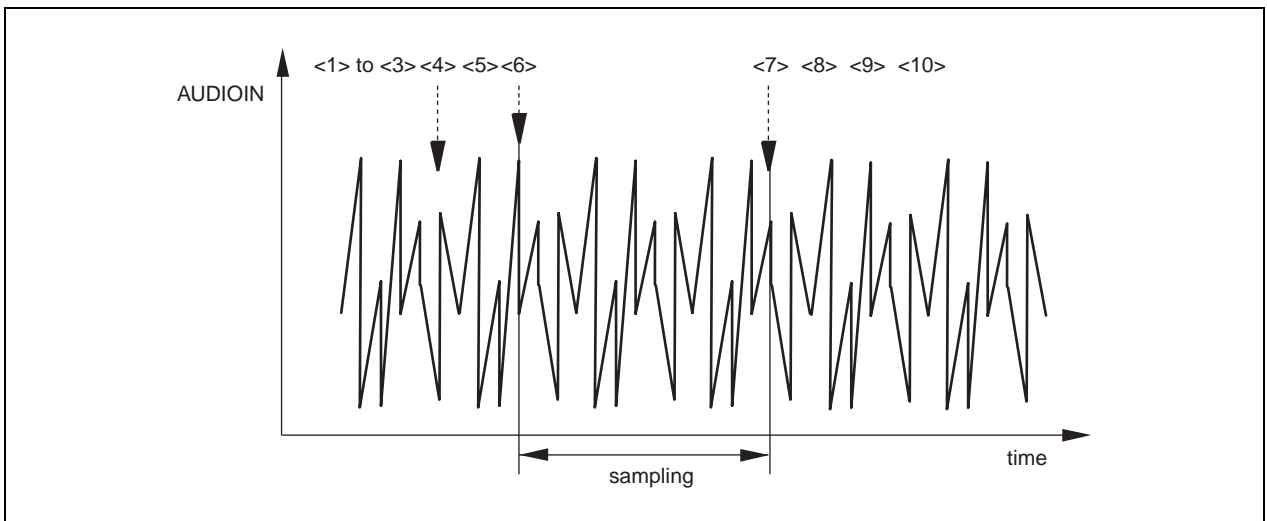

[MEMO]

CHAPTER 21 KEYBOARD INTERFACE UNIT (KIU)

21.1 General

The Keyboard Interface Unit (KIU) provides the interface between the V_R4181 and an external matrix type keyboard. This unit supports key matrix of 8 x 8.

The interface to the keyboard consists of SCANOUT and SCANIN lines. The SCANOUT lines are used to search the matrix for pressed keys. The SCANIN lines are used to sense key press events and are read after each SCANOUT line activation to locate the pressed key.

SCANOUT and SCANIN lines are allocated by programming V_R4181 CompactFlash pins to support this function. These pins are multiplexed. Only one configuration is set by the firmware during the power-on. SCANOUT lines are defined as 3-state outputs and SCANIN lines are inputs.

21.2 Functional Description

When the keyboard is idle, the SCANOUT lines are all driven to 0 volts and the SCANIN lines are pulled to V_{DD} by external 4.7 k Ω resistors. When any key in the matrix is pressed, at least one SCANIN input will be driven low and signals a key press event to the KIU.

Once the key press event has been detected, the KIU may be programmed to generate a Key Input Detection interrupt request and automatically begin scanning the keyboard or wait until software enables the scan operation.

Keyboard scanning is performed by sequentially driving one SCANOUT line low while the others remain 3-state and reading the state of the SCANIN lines into keyboard data registers inside the KIU. Once the last SCANOUT line has been driven low and the SCANIN lines read the KIU may generate a Keyboard Data Ready interrupt request to inform system software that one keyboard scan operation has been completed.

The KIU repeats this scan process until no further keys have been detected or until software disables the scan operation. At this point the KIU returns to the keyboard idle state and waits for the next key press event.

21.2.1 Automatic keyboard scan mode

Automatic Scan mode is enabled through the ATSCAN and ATSTP bits of the KIUSCANREP register. When the ATSCAN bit is set to 1, keyboard scanning starts automatically following a Key Detect Interrupt request. When the ATSTP bit is set to 1, keyboard scanning stops automatically after no valid keyboard data (i.e. all SCANIN lines are high level) has been read for the number of scan cycles specified by the STPREP(5:0) bits of the KIUSCANREP register.

21.2.2 Manual keyboard scan mode

Manual Scan mode is enabled through the MSTART and MSTOP bits of the KIUSCANREP register. Software initiates a keyboard scan operation by setting the MSTART bit to 1 and terminates keyboard scanning by setting the MSTOP bit to 1. When software sets the MSTOP bit to 1, the KIU will complete the current scan operation before disabling the scan logic. The following table illustrates the relationship between these bits:

ASTOP	ASTART	MSTART	MSTOP	Operation
0	0	0	0	Scanning disabled
X	X	X	1	Scanning stopped
0	X	1	0	Manual Scan mode. Scan operation starts as soon as the MSTART bit is detected by the scan sequencer and stops when the MSTOP bit is set to 1.
1	X	1	0	Manual Scan with Auto Stop mode. Scan operation starts as soon as the MSTART bit is detected by the scan sequencer and stops when no valid keyboard data has been read for STPREP(5:0) consecutive scan cycles.
0	1	0	0	Auto Scan with Manual Stop mode. Scan operation starts as soon as a key press is detected by the scan sequencer and stops when the MSTOP bit is set to 1.
1	1	0	0	Auto Scan mode. Scan operation starts as soon as a key press is detected by the scan sequencer and stops when no valid keyboard data has been read for STPREP(5:0) consecutive scan cycles.

21.2.3 Key press detection

All SCANIN lines are sampled by the KIU on the rising edge of the 32.768 kHz clock. When any SCANIN line is sampled as low for one rising and one falling edge of the 32.768 kHz clock, a Key Detect interrupt request is generated. If the ASTART bit of the KIUSCANREP register is set to 1, the KIU will also begin scanning the keyboard at this time.

21.2.4 Scan operation

Scan operations are controlled by the T1CNT(4:0) and T3CNT(4:0) bits of the KIUWKS register and the WINTVL(9:0) bits of the KIUWKI register. The following diagram illustrates the relationship of these register bits to the scan operation:

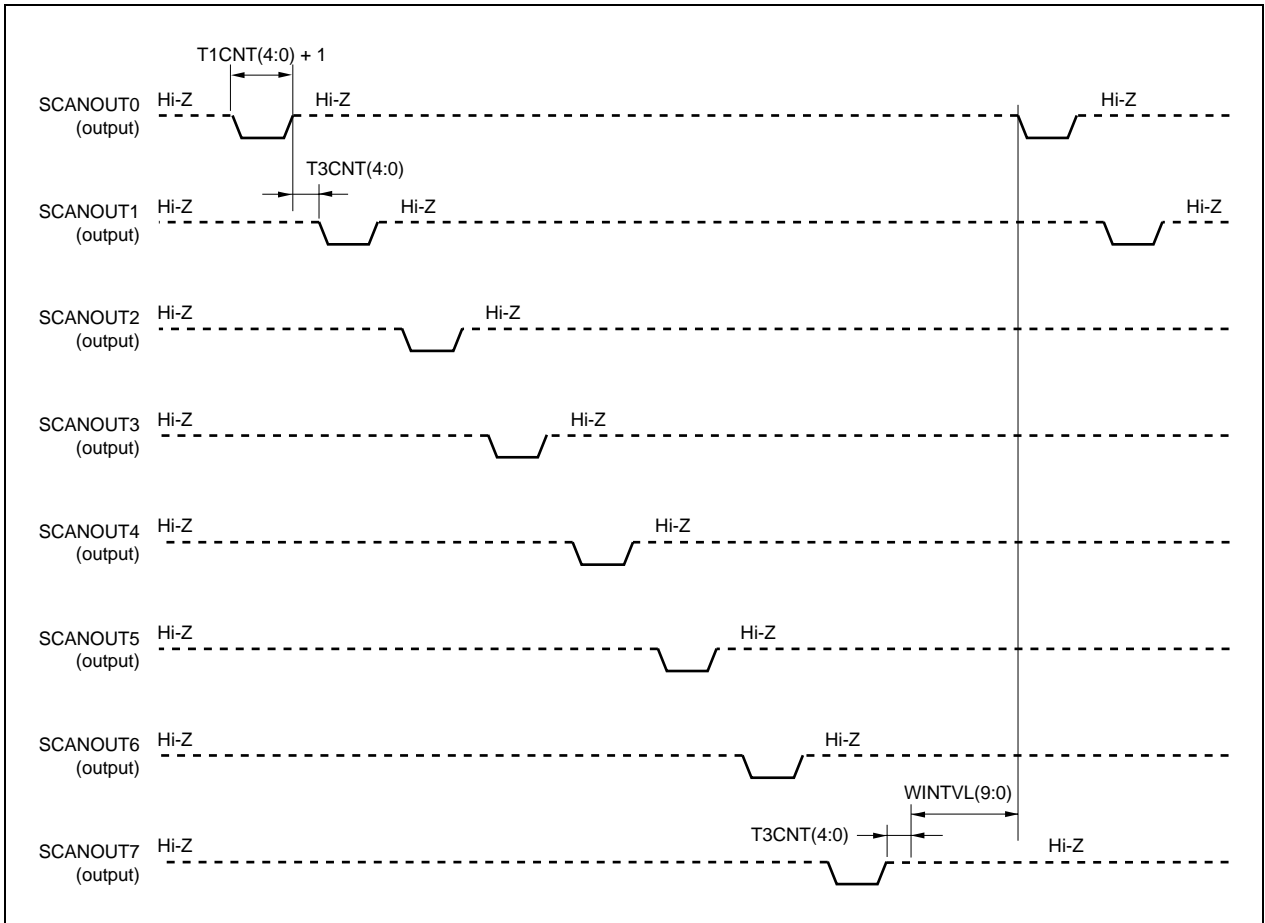

T1CNT(4:0) specifies the keyboard settling time and is expressed in 32.768 kHz clock cycles. Following activation of one of the SCANOUT(7:0) pins, the KIU will wait until the T1CNT(4:0) time before reading return data from the SCANIN(7:0) pins. The actual SCANOUT pins will be driven as low for $(T1CNT(4:0) + 1)$ 32.768kHz clock cycles.

T3CNT(4:0) specifies the delay from driving one SCANOUT pin as high impedance to activating the next SCANOUT pin and is also expressed in 32.768 kHz clock cycles. When SCANOUTn is driven as high impedance, the KIU will wait until the T3CNT(4:0) time before driving SCANOUTn+1 as low to allow the external pull-up resistors to return the SCANINn line as high (n = 0 to 6).

WINTVL(9:0) specifies the wait interval between scan cycles in 32.768 kHz clock cycles. After the last SCANOUT pin has been driven as high impedance and T3CNT(4:0) time elapsed, the KIU will wait until the WINTVL(9:0) time before driving SCANOUT0 as low to start the next scan sequence.

21.2.5 Reading return data

Return data is read from the SCANIN(7:0) pins. Once a SCANOUT pin has been driven as low and the keyboard settling time specified by T1CNT(4:0) has been satisfied, the KIU latches return data from the SCANIN pins into one of the internal Key Data registers.

21.2.6 Interrupts and status reporting

The KIU provides scan status that may be polled by the CPU core and may also generate interrupt requests to request keyboard servicing. Scan status reporting is provided through the SSTAT(1:0) bits of the KIUSCANS register. These bits are decoded as follows:

SSTAT1	SSTAT0	KIU scan sequencer status
0	0	Stopped
0	1	Waiting for key press
1	0	Scan cycle (T1CNT or T3CNT)
1	1	Idle (WINTVL(9:0))

The KIU also generates 3 types of maskable interrupt requests. KIU interrupt pending status is reported through the KDATLOST, KDATRDY, and KEYDOWN bits of the KIUINT register. All interrupt requests generated by the KIU should be considered asynchronous and must be externally qualified with TClock.

The KDATLOST interrupt request signals that a SCANIN write occurred to the Key Data register for SCANOUT0 before the previous data value was read by the CPU.core. This interrupt source can be masked through the MSKKDATLOST bit of the MKINTREG register.

The KDATRDY interrupt request signals one complete scan operation has been completed. This interrupt request is generated during the SCANIN write cycle that accesses the Key Data register for the last SCANOUT. This interrupt request source can be masked through the MSKKDATRDY bit of the MKINTREG register.

The KEYDOWN interrupt request signals a key press event has been detected. This interrupt request is generated on the rising edge of the 32.768 kHz clock when the keyboard interface is idle and any SCANIN pin is sampled low for one 32.768 kHz rising edge and one 32.768 kHz falling edge. This interrupt request source can be masked through the MSKKDOWNINT bit of the MKINTREG register.

The MSKKDATLOST, MSKKDATRDY, and MSKKDOWNINT bits only prevent interrupt requests from being generated on the KBDINTR signal. These mask bits do not disable interrupt request event detection nor do they disable interrupt status reporting in the KIUINT register.

21.3 Register Set

The KIU registers are listed below.

Table 21-1. KIU Registers

Address	R/W	Register symbol	Function
0x0B00 0180	R	KIUDAT0	Scan line 0 key data register
0x0B00 0182	R	KIUDAT1	Scan line 1 key data register
0x0B00 0184	R	KIUDAT2	Scan line 2 key data register
0x0B00 0186	R	KIUDAT3	Scan line 3 key data register
0x0B00 0188	R	KIUDAT4	Scan line 4 key data register
0x0B00 018A	R	KIUDAT5	Scan line 5 key data register
0x0B00 018C	R	KIUDAT6	Scan line 6 key data register
0x0B00 018E	R	KIUDAT7	Scan line 7 key data register
0x0B00 0190	R/W	KIUSCANREP	Scan/repeat register
0x0B00 0192	R	KIUSCANS	Scan status register
0x0B00 0194	R/W	KIUWKS	Wait key scan stable register
0x0B00 0196	R/W	KIUWKI	Wait key scan interval register
0x0B00 0198	R/W	KIUINT	Interrupt register

State of interrupt requests caused by KIU is indicated and can be set in the following registers, which are included in the ICU (refer to **CHAPTER 14 INTERRUPT CONTROL UNIT (ICU)** for details).

Table 21-2. KIU Interrupt Registers

Address	R/W	Register symbol	Function
0x0B00 0092	R/W	MKIUINTREG	AIU interrupt mask register
0x0B00 0198	R	KIUINTREG	AIU interrupt indication register

21.3.1 KIUDATn (0x0B00 0180 to 0x0B00 018E)

Remark n = 0 to 7

KIUDAT0 (0x0B00 0180)	KIUDAT4 (0x0B00 0188)
KIUDAT1 (0x0B00 0182)	KIUDAT5 (0x0B00 018A)
KIUDAT2 (0x0B00 0184)	KIUDAT6 (0x0B00 018C)
KIUDAT3 (0x0B00 0186)	KIUDAT7 (0x0B00 018E)

Bit	15	14	13	12	11	10	9	8
Name	Reserved	Reserved	Reserved	Reserved	Reserved	Reserved	Reserved	Reserved
R/W	R	R	R	R	R	R	R	R
RTCRST	0	0	0	0	0	0	0	0
Other resets	0	0	0	0	0	0	0	0

Bit	7	6	5	4	3	2	1	0
Name	RETDAT7	RETDAT6	RETDAT5	RETDAT4	RETDAT3	RETDAT2	RETDAT1	RETDAT0
R/W	R	R	R	R	R	R	R	R
RTCRST	0	0	0	0	0	0	0	0
Other resets	0	0	0	0	0	0	0	0

Bit	Name	Function
15 to 8	Reserved	0 is returned when read
7 to 0	RETDAT(7:0)	Scan data 1 : Key is released 0 : Key is pressed

These registers reflect the state of the return signals for the selected SCANOUT pins. Each register corresponds to one SCANOUT pin as follows:

SCANOUT pin	KIUDAT register
SCANOUT7	KIUDAT7
SCANOUT6	KIUDAT6
SCANOUT5	KIUDAT5
SCANOUT4	KIUDAT4
SCANOUT3	KIUDAT3
SCANOUT2	KIUDAT2
SCANOUT1	KIUDAT1
SCANOUT0	KIUDAT0

21.3.2 KIUSCANREP (0x0B00 0190)

Bit	15	14	13	12	11	10	9	8
Name	KEYEN	Reserved	Reserved	Reserved	Reserved	Reserved	STPREP5	STPREP4
R/W	R/W	R	R	R	R	R	R/W	R/W
RTCRST	0	0	0	0	0	0	0	0
Other resets	0	0	0	0	0	0	0	0

Bit	7	6	5	4	3	2	1	0
Name	STPREP3	STPREP2	STPREP1	STPREP0	MSTOP	MSTART	ASTOP	ASTART
R/W	R/W	R/W	R/W	R/W	R/W	R/W	R/W	R/W
RTCRST	0	0	0	0	0	0	0	0
Other resets	0	0	0	0	0	0	0	0

Bit	Name	Function
15	KEYEN	KIU enable This bit enables a KIU operation. When this bit is set to 0, the scan sequencer and all interrupt requests are disabled. 1 : Enable 0 : Disable
14 to 10	Reserved	0 is returned when read
9 to 4	STPREP(5:0)	Scan sequencer stop count setting These bits select the number of scan operation performed after all keys have been released (0xFF is loaded to all KIUDAT registers). 111111 : 63 times : 000001 : 1 time 000000 : 64 times
3	MSTOP	Scan stop This bit is sampled at the end of each scan operation and causes the scan sequencer to stop scanning when set to 1. 1 : Stop 0 : Operate
2	MSTART	Manual scan start When this bit is set to 1, the scan sequencer starts scanning the keyboard. 1 : Start 0 : Stop
1	ASTOP	Auto scan stop When this bit is set to 1, the scan sequencer stops scanning automatically when all keys have been released for the number of scan operation specified by the STPREP(5:0) bits. 1 : Auto Stop mode 0 : Manual Stop mode
0	ASTART	Auto Scan mode enable When this bit is set to 1, the scan sequencer starts scanning automatically following a key press even. 1 : Enable 0 : Disable

21.3.3 KIUSCANS (0x0B00 0192)

Bit	15	14	13	12	11	10	9	8
Name	Reserved	Reserved	Reserved	Reserved	Reserved	Reserved	Reserved	Reserved
R/W	R	R	R	R	R	R	R	R
RTCRST	0	0	0	0	0	0	0	0
Other resets	0	0	0	0	0	0	0	0

Bit	7	6	5	4	3	2	1	0
Name	Reserved	Reserved	Reserved	Reserved	Reserved	Reserved	SSTAT1	SSTAT0
R/W	R	R	R	R	R	R	R	R
RTCRST	0	0	0	0	0	0	0	0
Other resets	0	0	0	0	0	0	0	0

Bit	Name	Function
15 to 2	Reserved	0 is returned when read
1 to 0	SSTAT(1:0)	Scan sequencer status 11 : Idle (WINTVL(9:0)) 10 : Scan cycle (T1CNT or T3CNT) 01 : Waiting for key press 00 : Stopped

21.3.4 KIUWKS (0x0B00 0194)

Bit	15	14	13	12	11	10	9	8
Name	Reserved	T3CNT4	T3CNT3	T3CNT2	T3CNT1	T3CNT0	Reserved	Reserved
R/W	R	R/W	R/W	R/W	R/W	R/W	R	R
RTCRST	0	0	0	0	0	0	0	0
Other resets	0	0	0	0	0	0	0	0

Bit	7	6	5	4	3	2	1	0
Name	Reserved	Reserved	T2CNT0	T1CNT4	T1CNT3	T1CNT2	T1CNT1	T1CNT0
R/W	R	R	R/W	R/W	R/W	R/W	R/W	R/W
RTCRST	0	0	0	0	0	0	0	0
Other resets	0	0	0	0	0	0	0	0

Bit	Name	Function
15	Reserved	0 is returned when read
14 to 10	T3CNT(4:0)	Return data stabilization time These bit determine the time the scan sequencer waits following an assertion of a SCANOUT pin before return data is read. 11111 : 960 μ s : (T3CNT(4:0) + 1) x 30 μ s 00001 : 60 μ s 00000 : Setting prohibited when using KIU
9 to 5	Reserved	0 is returned when read
4 to 0	T1CNT(4:0)	Scan stabilization time These bits determine the time the scan sequencer waits following a deassertion of one SCANOUT pin before an assertion of the next SCANOUT pin. 11111 : 960 μ s : (T1CNT(4:0) + 1) x 30 μ s 00001 : 60 μ s 00000 : Setting prohibited when using KIU

21.3.5 KIUWKI (0x0B00 0196)

Bit	15	14	13	12	11	10	9	8
Name	Reserved	Reserved	Reserved	Reserved	Reserved	Reserved	WINTVL9	WINTVL8
R/W	R	R	R	R	R	R	R/W	R/W
RTCRST	0	0	0	0	0	0	0	0
Other resets	0	0	0	0	0	0	0	0

Bit	7	6	5	4	3	2	1	0
Name	WINTVL7	WINTVL6	WINTVL5	WINTVL4	WINTVL3	WINTVL2	WINTVL1	WINTVL0
R/W	R/W	R/W	R/W	R/W	R/W	R/W	R/W	R/W
RTCRST	0	0	0	0	0	0	0	0
Other resets	0	0	0	0	0	0	0	0

Bit	Name	Function
15 to 10	Reserved	0 is returned when read
9 to 0	WINTVL(9:0)	<p>Scan interval time</p> <p>These bits determine the time the scan sequencer waits following completion of one scan operation before starting the next scan operation.</p> <p>1111111111 : 30690 μs</p> <p> : WINTVL(9:0) x 30 μs</p> <p>0000000001 : 30 μs</p> <p>0000000000 : No Wait</p>

21.3.6 KIUINT (0x0B00 0198)

Bit	15	14	13	12	11	10	9	8
Name	Reserved	Reserved	Reserved	Reserved	Reserved	Reserved	Reserved	Reserved
R/W	R	R	R	R	R	R	R	R
RTCRST	0	0	0	0	0	0	0	0
Other resets	0	0	0	0	0	0	0	0

Bit	D7	D6	D5	D4	D3	D2	D1	D0
Name	Reserved	Reserved	Reserved	Reserved	Reserved	KDATLOST	KDATRDY	KEYDOWN
R/W	R	R	R	R	R	R/W	R/W	R/W
RTCRST	0	0	0	0	0	0	0	0
Other resets	0	0	0	0	0	0	0	0

Bit	Name	Function
15 to 3	Reserved	0 is returned when read
2	KDATLOST	Key Data Lost interrupt pending. Cleared to 0 when 1 is written. This interrupt request occurs when the KIUDAT0 register is updated before being read by the CPU core. 1 : Data lost
1	KDATRDY	Key Data Ready interrupt pending. Cleared to 0 when 1 is written. This interrupt request occurs when the last enabled KIUDAT register is updated. 1 : Data ready
0	KEYDOWN	Key Press Event interrupt pending. Cleared to 0 when 1 is written. This interrupt request occurs when the scan sequencer is idle and any of SDANIN pins are sampled as low. 1 : Key press

[MEMO]

CHAPTER 22 COMPACTFLASH CONTROLLER (ECU)

22.1 General

The VR4181 provides an ExCA-compatible controller supporting a single CompactFlash slot. The interface for this controller is shared with that of the keyboard interface unit. To use this interface for CompactFlash control, the KEYSEL bit of the KEYEN register (0x0B00 031C) must be clear to 0. Also, to use CF_INTR as wake-up source, the CompactFlash interface must be enabled during Hibernate mode by writing 1 to CFHIBEN bit of the KEYEN register.

22.2 Register Set Summary

This section provides details of the ECU registers. Two of the ECU registers are located in the I/O addressing space. These registers, as well as the Interrupt and Configuration registers, are shown in the following table.

Table 22-1. ECU Control Registers

Address	R/W	Register symbol	Function
0x0B00 08E0	R/W	ECUINDX	Index register
0x0B00 08E1	R/W	ECUDATA	Data register
0x0B00 08F8	R	INTSTATREG	Interrupt status register
0x0B00 08FA	R/W	INTMSKREG	Interrupt mask register
0x0B00 08FE	R/W	CFG_REG_1	Configuration register 1

The remaining ECU registers are all 8-bit width and accessed through the Index register and the Data register, as listed below.

Table 22-2. ECU Registers (1/2)

Index address	R/W	Register symbol	Function
0x0000	R	ID_REV_REG	Identification and revision register
0x0001	R	IF_STAT_REG	Interface status register
0x0002	R/W	PWRRSETDRV	Power and RESETDRV control register
0x0003	R/W	ITGENCTREG	Interrupt and general control register
0x0004	R/W	CDSTCHGREG	Card status change register
0x0005	R/W	CRDSTATREG	Card status change interrupt configuration register
0x0006	R/W	ADWINENREG	Address window enable register
0x0007	R/W	IOCTRL_REG	I/O control register
0x0008	R/W	IOADSLB0REG	I/O address 0 start low byte register
0x0009	R/W	IOADSHB0REG	I/O address 0 start high byte register
0x000A	R/W	IOSLB0REG	I/O address 0 stop low byte register
0x000B	R/W	IOSHB0REG	I/O address 0 stop high byte register
0x000C	R/W	IOADSLB1REG	I/O address 1 start low byte register
0x000D	R/W	IOADSHB1REG	I/O address 1 start high byte register
0x000E	R/W	IOSLB1REG	I/O address 1 stop low byte register
0x000F	R/W	IOSHB1REG	I/O address 1 stop high byte register
0x0010	R/W	SYSTEMSL0REG	System memory address 0 mapping start low byte register
0x0011	R/W	MEMWID0_REG	System memory address 0 mapping start high byte register
0x0012	R/W	SYSTEMEL0REG	System memory address 0 mapping stop low byte register
0x0013	R/W	MEMSEL0_REG	System memory address 0 mapping stop high byte register
0x0014	R/W	MEMOFFL0REG	Card memory offset address 0 low byte register
0x0015	R/W	MEMOFFH0REG	Card memory offset address 0 high byte register
0x0016	R/W	DTGENCLREG	Card detect and general control register
0x0018	R/W	SYSTEMSL1REG	System memory address 1 mapping start low byte register
0x0019	R/W	MEMWID1_REG	System memory address 1 mapping start high byte register
0x001A	R/W	SYSTEMEL1REG	System memory address 1 mapping stop low byte register
0x001B	R/W	MEMSEL1_REG	System memory address 1 mapping stop high byte register
0x001C	R/W	MEMOFFL1REG	Card memory offset address 1 low byte register
0x001D	R/W	MEMOFFH1REG	Card memory offset address 1 high byte register
0x001E	R/W	GLOCTRLREG	Global control register
0x001F	R	VOLTSENREG	Card voltage sense register

Table 22-2. ECU Registers (2/2)

Index address	R/W	Register symbol	Function
0x0020	R/W	SYSTEMSL2REG	System memory address 2 mapping start low byte register
0x0021	R/W	MEMWID2_REG	System memory address 2 mapping start high byte register
0x0022	R/W	SYSTEMEL2REG	System memory address 2 mapping stop low byte register
0x0023	R/W	MEMSEL2_REG	System memory address 2 mapping stop high byte register
0x0024	R/W	MEMOFFL2REG	Card memory offset address 2 low byte register
0x0025	R/W	MEMOFFH2REG	Card memory offset address 2 high byte register
0x0028	R/W	SYSTEMSL3REG	System memory address 3 mapping start low byte register
0x0029	R/W	MEMWID3_REG	System memory address 3 mapping start high byte register
0x002A	R/W	SYSTEMEL3REG	System memory address 3 mapping stop low byte register
0x002B	R/W	MEMSEL3_REG	System memory address 3 mapping stop high byte register
0x002C	R/W	MEMOFFL3REG	Card memory offset address 3 low byte register
0x002D	R/W	MEMOFFH3REG	Card memory offset address 3 high byte register
0x002F	R/W	VOLTSELREG	Card voltage select register
0x0030	R/W	SYSTEMSL4REG	System memory address 4 mapping start low byte register
0x0031	R/W	MEMWID4_REG	System memory address 4 mapping start high byte register
0x0032	R/W	SYSTEMEL4REG	System memory address 4 mapping stop low byte register
0x0033	R/W	MEMSEL4_REG	System memory address 4 mapping stop high byte register
0x0034	R/W	MEMOFFL4REG	Card memory offset address 4 low byte register
0x0035	R/W	MEMOFFH4REG	Card memory offset address 4 high byte register

22.3 ECU Control Registers

22.3.1 INTSTATREG (0x0B00 08F8)

Bit	15	14	13	12	11	10	9	8
Name	IRQ15	IRQ14	Reserved	IRQ12	IRQ11	IRQ10	IRQ9	Reserved
R/W	R	R	R	R	R	R	R	R
Reset	0	0	0	0	0	0	0	0

Bit	7	6	5	4	3	2	1	0
Name	IRQ7	Reserved	IRQ5	IRQ4	IRQ3	Reserved	Reserved	Reserved
R/W	R	R	R	R	R	R	R	R
Reset	0	0	0	0	0	0	0	0

Bit	Name	Function
15, 14	IRQ(15:14)	Status of interrupt request 15 and 14 (internal) 0 : Invalid 1 : Valid
13	Reserved	0 is returned when read
12 to 9	IRQ(12:9)	Status of interrupt request 12, 11, 10 and 9 (internal) 0 : Invalid 1 : Valid
8	Reserved	0 is returned when read
7	IRQ7	Status of interrupt request 7 (internal) 0 : Invalid 1 : Valid
6	Reserved	0 is returned when read
5 to 3	IRQ(5:3)	Status of interrupt request 5, 4 and 3 (internal) 0 : Invalid 1 : Valid
2 to 0	Reserved	0 is returned when read

Remark A single bit corresponds to each interrupt request.

22.3.2 INTMSKREG (0x0B00 08FA)

Bit	15	14	13	12	11	10	9	8
Name	IMSK015	IMSK014	Reserved	IMSK012	IMSK011	IMSK010	IMSK009	Reserved
R/W	R/W	R/W	R	R/W	R/W	R/W	R/W	R
Reset	0	0	0	0	0	0	0	0

Bit	7	6	5	4	3	2	1	0
Name	IMSK07	Reserved	IMSK05	IMSK04	IMSK03	Reserved	Reserved	Reserved
R/W	R/W	R	R/W	R/W	R/W	R	R	R
Reset	0	0	0	0	0	0	0	0

Bit	Name	Function
15, 14	IMSK0(15:14)	Mask for interrupt request 15 and 14 (internal) 0 : Unmask 1 : Mask
13	Reserved	0 is returned when read
12 to 9	IMSK0(12:9)	Mask for interrupt request 12, 11, 10, and 9 (internal) 0 : Unmask 1 : Mask
8	Reserved	0 is returned when read
7	IMSK07	Mask for interrupt request 7 (internal) 0 : Unmask 1 : Mask
6	Reserved	0 is returned when read
5 to 3	IMSK0(5:3)	Mask for interrupt request 5, 4 and 3 (internal) 0 : Unmask 1 : Mask
2 to 0	Reserved	0 is returned when read

Remark A single bit corresponds to each interrupt request.

Figure 22-1. CompactFlash Interrupt Logic

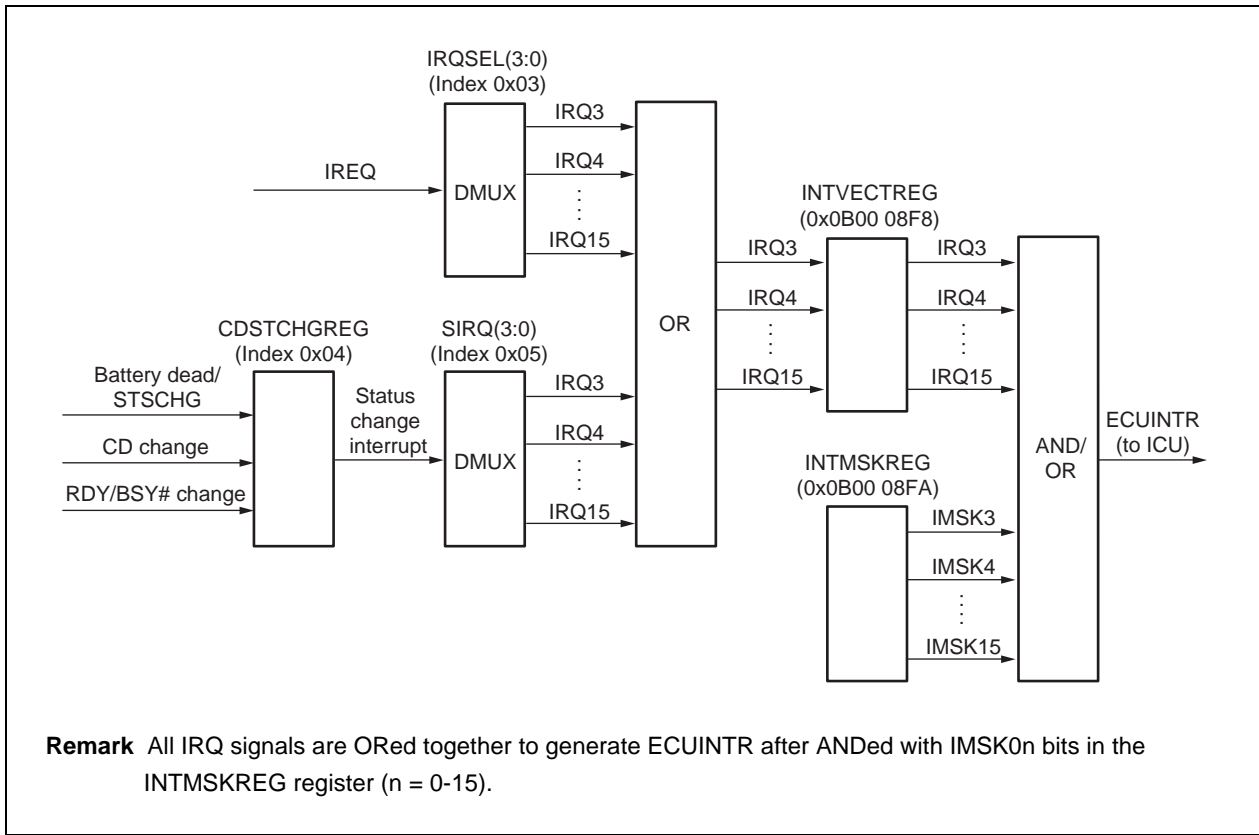

22.3.3 CFG_REG_1 (0x0B00 08FE)

Bit	15	14	13	12	11	10	9	8
Name	Reserved	Reserved	Reserved	Reserved	Reserved	Reserved	Reserved	Reserved
R/W	R	R	R	R	R	R	R	R
Reset	0	0	0	0	0	0	0	0

Bit	7	6	5	4	3	2	1	0
Name	Reserved	Reserved	Reserved	Reserved	Reserved	Reserved	Reserved	WSE
R/W	R	R	R	R	R	R	R	R/W
Reset	0	0	0	0	0	0	0	1

Bit	Name	Function
15 to 1	Reserved	0 is returned when read
0	WSE	Wait state enable 0 : Disable 1 wait state for peripheral interface 1 : Enable 1 wait state for peripheral interface

22.4 ECU Registers

22.4.1 ID_REV_REG (Index: 0x00)

Bit	7	6	5	4	3	2	1	0
Name	IFTYP1	IFTYP0	Reserved	Reserved	REV3	REV2	REV1	REV0
R/W	R	R	R	R	R	R	R	R
Reset	1	0	0	0	0	0	1	1

Bit	Name	Function
7, 6	IFTYP(1:0)	PCSC interface type These bits indicate 10 to reflect support for both memory and I/O cards.
5, 4	Reserved	0 is returned when read
3 to 0	REV(3:0)	These bits identify the revision level. 0011 is always displayed.

22.4.2 IF_STAT_REG (Index: 0x01)

Bit	7	6	5	4	3	2	1	0
Name	Reserved	PWRON	RDY/BSY	WP	CD2	CD1	Reserved	BVD1
R/W	R	R	R	R	R	R	R	R
Reset	1	0	Undefined	Undefined	1	1	0	Undefined

Bit	Name	Function
7	Reserved	1 is returned when read
6	PWRON	CompactFlash card power status 0 : Off 1 : On
5	RDY/BSY	CompactFlash card Ready/Busy status. This bit indicates the current status of CF_BUSY# signal. 0 : Busy 1 : Ready
4	WP	Memory write protect switch status. This bit indicates the current status of CF_IOIS16# signal. 0 : Off 1 : On
3, 2	CD(2:1)	Complement of the values of CD1# and CD2# on the CompactFlash interface ^{Note} 11: Active (CD pins are low level) 00 : Inactive (CD pins are high level) Values other than above are not displayed.
1	Reserved	0 is returned when read
0	BVD1	This bit indicates the current status of STSCHG# signal from the CompactFlash card.

Note The card detect pins, CD1# and CD2#, alternate with GPIO pins. When the GPIO pins are not programmed as card detect input, CD(2:1) bits of this register always return 1 (active). In this way, the CompactFlash interface can be used without the card detect pins. When the GPIO pins are programmed as card detect, CD(2:1) bits are reflected in actual CD1# and CD2# pins status.

22.4.3 PWRRSETDRV (Index: 0x02)

Bit	7	6	5	4	3	2	1	0
Name	OE	Reserved	Reserved	PWREN	Reserved	Reserved	Reserved	Reserved
R/W	R/W	R	R	R/W	R	R	R/W	R
Reset	0	0	1	0	0	0	0	0

Bit	Name	Function
7	OE	Output enable. If this bit is cleared to 0, the CompactFlash interface outputs from the VR4181 are driven to high impedance state and the CF_DEN#, CF_AEN# output is driven high. Caution This bit should not be set until after this register has been written to set the CompactFlash card power enable.
6	Reserved	0 is returned when read
5	Reserved	1 is returned when read
4	PWREN	Card power enable 0 : Disabled (Vcc is negated) 1 : Enabled. Voltage selected according to VOLTSELREG register (0x2F) is applied. The power to the socket is turned on when a card is inserted and off when removed.
3, 2	Reserved	0 is returned when read
1	Reserved	Write 0 when write. 0 is returned when read.
0	Reserved	0 is returned when read

22.4.4 ITGENCTREG (Index: 0x03)

Bit	7	6	5	4	3	2	1	0
Name	RI_EN	CRDRST	CRDTYP	Reserved	IRQSEL3	IRQSEL2	IRQSEL1	IRQSEL0
R/W	R/W	R/W	R/W	R	R/W	R/W	R/W	R/W
Reset	0	0	0	0	0	0	1	1

Bit	Name	Function
7	RI_EN	<p>Ring indicate enable. For memory PC Cards, this bit has no function.</p> <p>0 : For I/O cards, the STSCHG#/RI# signal from the I/O card is used as the status change signal STSCHG#. The current status of the signal is then available to be read from the IF_STAT_REG register for this signal can be configured as a source for the card status change interrupt.</p> <p>1 : For I/O cards, the STSCHG#/RI# signal from the I/O card is used as a ring indicator signal. It is OR'd with the bit in the PMU and may be used to cause a resume from SUSPEND mode.</p>
6	CRDRST	<p>Card reset. This is a software reset to the PC Card.</p> <p>0 : Activates the CF_RESET signal to the Card. The CF_RESET signal will be active until this bit is set to 1.</p> <p>1 : Deactivates the CF_RESET signal to the Card.</p>
5	CRDTYP	<p>Card type</p> <p>0 : Memory card</p> <p>1 : I/O card</p>
4	Reserved	0 is returned when read
3 to 0	IRQSEL(3:0)	<p>Interrupt steering for the I/O card IREQ. These bits select the redirection of the I/O card IREQ interrupt request.</p> <p>0000 : IRQ not selected</p> <p>0001 : RFU</p> <p>0010 : RFU</p> <p>0011 : IRQ3 enabled</p> <p>0100 : IRQ4 enabled</p> <p>0101 : IRQ5 enabled</p> <p>0110 : RFU</p> <p>0111 : IRQ7 enabled</p> <p>1000 : RFU</p> <p>1001 : IRQ9 enabled</p> <p>1010 : IRQ10 enabled</p> <p>1011 : IRQ11 enabled</p> <p>1100 : IRQ12 enabled</p> <p>1101 : RFU</p> <p>1110 : IRQ14 enabled</p> <p>1111 : IRQ15 enabled</p>

22.4.5 CDSTCHGREG (Index: 0x04)

Bit	7	6	5	4	3	2	1	0
Name	Reserved	Reserved	Reserved	Reserved	CD_CHG	RDY_CHG	Reserved	BAT_DEAD
R/W	R	R	R	R	R/W	R/W	R	R/W
Reset	0	0	0	0	0	0	0	0

Bit	Name	Function
7 to 4	Reserved	0 is returned when read
3	CD_CHG	Card detect status change 0 : No change detected on either of CD1# or CD2# 1 : A change has been detected on CD1# or CD2#
2	RDY-CHG	Ready change 0 : No change detected on RDY/BSY#, or I/O card installed 1 : A low-to-high change has been detected on RDY/BSY indicating that the memory card is ready to accept a new data transfer
1	Reserved	0 is returned when read
0	BAT_DEAD	Battery dead or STSCHG 0 : For memory cards, battery is good. For I/O cards, the RI_EN bit of the ITGENCTREG register is set to 1, or STSCHG#/RI# is high level. 1 : For memory cards, a battery dead condition has been detected. For I/O cards, the RI_EN bit of the ITGENCTREG register is cleared to 0 and the STSCHG#/RI# signal from the I/O card has been pulled low. The system software then has to read the status change register in the card to determine the cause of STSCHG.

This register provides the source of the card status change interrupt request. Each source can be enabled to generate this interrupt request by setting the corresponding bit in the CRDSTATREG register. The bits in this register become 0 if their corresponding enable bits are cleared to 0.

If the EXWRBK bit is set to 1 in the GLOCTRLREG register, sources for the card status change interrupt request is acknowledged by writing back 1 to the appropriate bit in the CDSTCHGREG register that was read as 1. Once acknowledged, that particular bit in the CDSTCHGREG register is cleared to 0. The interrupt request signal caused by the card status change, if enabled on a system IRQ line, is active until all the bits in this register become 0.

If the EXWRBK bit is not set to 1, the card status change interrupt request, when enabled on an IRQ line, remains active until this register is read. In this mode, reading this register resets all status bits to 0, which has been set to 1.

22.4.6 CRDSTATREG (Index: 0x05)

bit	7	6	5	4	3	2	1	0
Name	SIRQS3	SIRQS2	SIRQS1	SIRQSO	CD_EN	RDY_EN	Reserved	BDEAD_EN
R/W	R/W	R/W	R/W	R/W	R/W	R/W	R	R/W
Reset	0	0	0	0	0	0	0	0

Bit	Name	Function
7 to 4	SIRQ(3:0)	<p>Interrupt steering for the interrupt request. These bits select the redirection of the STSCHG interrupt request.</p> <p>0000 : IRQ not selected 0001 : RFU 0010 : RFU 0011 : IRQ3 enabled 0100 : IRQ4 enabled 0101 : IRQ5 enabled 0110 : RFU 0111 : IRQ7 enabled 1000 : RFU 1001 : IRQ9 enabled 1010 : IRQ10 enabled 1011 : IRQ11 enabled 1100 : IRQ12 enabled 1101 : RFU 1110 : IRQ14 enabled 1111 : IRQ15 enabled</p>
3	CD_EN	<p>Card detect enable</p> <p>0 : Disables the generation of a card status change interrupt request when the card detect signals change state 1 : Enables a card status change interrupt request when a change has been detected on CD1# or CD2# signals</p>
2	RDY_EN	<p>Ready enable</p> <p>0 : Disables the generation of a card status change interrupt request when a low-to-high transition has been detected on the RDY/BSY# signal 1 : Enables a card status change interrupt request when a low-to-high transition has been detected on the RDY/BSY# signal</p>
1	Reserved	0 is returned when read
0	BDEAD_EN	<p>Battery dead or STSCHG enable</p> <p>0 : Disables the generation of a card status change interrupt request when either a battery dead condition (memory card) or an active STSCHG# (I/O card) is detected. 1 : For memory cards, enables a card status change interrupt request when a battery dead condition has been detected. For I/O cards, enables a card status change interrupt request if the STSCHG#/RI# signal has been pulled low by the I/O card, assuming the RI_EN bit of the ITGENCTREG0 register is cleared to 0.</p>

22.4.7 ADWINENREG (Index: 0x06)

Bit	7	6	5	4	3	2	1	0
Name	IOWEN1	IOWEN0	Reserved	MWEN4	MWEN3	MWEN2	MWEN1	MWEN0
R/W	R/W	R/W	R	R/W	R/W	R/W	R/W	R/W
Reset	0	0	0	0	0	0	0	0

Bit	Name	Function
7 to 6	IOWEN(1:0)	<p>I/O window enables</p> <p>0 : Does not generate the card enable signals to the card when an I/O access occurs within the corresponding I/O address window.</p> <p>1 : Generates the card enable signals to the card when an I/O access occurs within the corresponding I/O address window. I/O accesses pass addresses from the system bus directly to the card.</p> <p>Caution The start and stop address register pairs must all be set to the desired window values before setting these bits to 1.</p>
5	Reserved	0 is returned when read
4 to 0	MWEN(4:0)	<p>Memory window enables</p> <p>0 : Does not generate the card enable signals to the card when a memory access occurs within the corresponding memory address window.</p> <p>1 : Generate the card enable signals to the card when a memory access occurs within the corresponding memory address window. When the system address is within the window, the computed address will be generated to the Card.</p> <p>Caution The start, stop, and offset address register pairs must all be set to the desired window values before setting these bits to 1.</p>

Remark A single bit corresponds to each window.

22.4.8 IOCTRL_REG (Index: 0x07)

Bit	7	6	5	4	3	2	1	0
Name	IO1WT	W1_IOWS	IO1_CS16 MD	IO1DSZ	W0_IOWS	IO0WT8	IO0_CS16 MD	IO0DSZ
R/W	R/W	R/W	R/W	R/W	R/W	R/W	R/W	R/W
Reset	0	0	0	0	0	0	0	0

Bit	Name	Function
7	IO1WT	I/O window 1 wait state in 16-bit system accesses 0 : Without additional wait state 1 : With 1 additional wait state
6	W1_IOWS	Add 1 additional wait state for an I/O window 1 access 0 : No additional wait state 1 : Add 1 wait state
5	IO1_CS16MD	I/O window 1 IOCS16 source 0 : Value of the data size bit 1 : IOCS16 signal returned from the card
4	IO1DSZ	I/O window 1 data size 0 : 8 bits 1 : 16 bits
3	IO0WT	I/O window 0 wait state in 16-bit system accesses 0 : Without additional wait state 1 : With 1 additional wait state
2	W0_IOWS	Add 1 additional wait state for an I/O window 0 access 0 : No additional wait state 1 : Add 1 wait state
1	IO0_CS16MD	I/O window 0 IOCS16 source 0 : Value of the data size bit 1 : IOIS16 signal returned from the card
0	IO0DSZ	I/O window 0 data size 0 : 8 bits 1 : 16 bits

22.4.9 IOADSLBnREG (Index: 0x08, 0x0C)

Remark n = 0, 1
 IOADSLB0REG (0x08): for Window 0
 IOADSLB1REG (0x0C): for Window 1

Bit	7	6	5	4	3	2	1	0
Name	STARTA7	STARTA6	STARTA5	STARTA4	STARTA3	STARTA2	STARTA1	STARTA0
R/W	R/W	R/W	R/W	R/W	R/W	R/W	R/W	R/W
Reset	0	0	0	0	0	0	0	0

Bit	Name	Function
7 to 0	STARTA(7:0)	I/O window start address bit 7 to 0

Low-order address bits used to determine the start address of the corresponding I/O address window. This provides a minimum 1 byte window for the I/O address window.

22.4.10 IOADSHBnREG (Index: 0x09, 0x0D)

Remark n = 0, 1
 IOADSHB0REG (0x09): for Window 0
 IOADSHB1REG (0x0D): for Window 1

Bit	7	6	5	4	3	2	1	0
Name	STARTA15	STARTA14	STARTA13	STARTA12	STARTA11	STARTA10	STARTA9	STARTA8
R/W	R/W	R/W	R/W	R/W	R/W	R/W	R/W	R/W
Reset	0	0	0	0	0	0	0	0

Bit	Name	Function
7 to 0	STARTA(15:8)	I/O window start address bit 15 to 8

High-order address bits used to determine the start address of the corresponding I/O address window.

Remark Address bits 25 to 16 of an I/O window are fixed to 0. Therefore, an I/O window is always mapped to the address space between 0x1400 0000 and 0x1400 FFFF, which is the first 64 Kbytes of the ISA-IO space.

22.4.11 IOSLBnREG (Index: 0x0A, 0x0E)

Remark n = 0, 1
 IOSLB0REG (0x0A): for Window 0
 IOSLB1REG (0x0E): for Window 1

Bit	7	6	5	4	3	2	1	0
Name	STOPA7	STOPA6	STOPA5	STOPA4	STOPA3	STOPA2	STOPA1	STOPA0
R/W	R/W	R/W	R/W	R/W	R/W	R/W	R/W	R/W
Reset	0	0	0	0	0	0	0	0

Bit	Name	Function
7 to 0	STOPA(7:0)	I/O window stop address bit 7 to 0

Low-order address bits used to determine the stop address of the corresponding I/O address window.

22.4.12 IOSHBnREG (Index: 0x0B, 0x0F)

Remark n = 0, 1
 IOSHB0REG (0x0B): for Window 0
 IOSHB1REG (0x0F): for Window 1

Bit	7	6	5	4	3	2	1	0
Name	STOPA15	STOPA14	STOPA13	STOPA12	STOPA11	STOPA10	STOPA9	STOPA8
R/W	R/W	R/W	R/W	R/W	R/W	R/W	R/W	R/W
Reset	0	0	0	0	0	0	0	0

Bit	Name	Function
7 to 0	STOPA(15:8)	I/O window stop address bit 15 to 8

High-order address bits used to determine the start address of the corresponding I/O address window.

Remark Address bits 25 to 16 of an I/O window are fixed to 0. Therefore, an I/O window is always mapped to the address space between 0x1400 0000 and 0x1400 FFFF, which is the first 64 Kbytes of the ISA-IO space.

22.4.13 SYSMEMSLnREG (Index: 0x10, 0x18, 0x20, 0x28, 0x30)

Remark n = 0 to 4

SYSMEMSL0REG (0x10): for Window 0 SYSMEMSL3REG (0x28): for Window 3
 SYSMEMSL1REG (0x18): for Window 1 SYSMEMSL4REG (0x30): for Window 4
 SYSMEMSL2REG (0x20): for Window 2

Bit	7	6	5	4	3	2	1	0
Name	MWSTART A19	MWSTART A18	MWSTART A17	MWSTART A16	MWSTART A15	MWSTART A14	MWSTART A13	MWSTART A12
R/W	R/W	R/W	R/W	R/W	R/W	R/W	R/W	R/W
Reset	0	0	0	0	0	0	0	0

Bit	Name	Function
7 to 0	MWSTARTA(19:12)	Memory window start address bit 19 to 12

Low-order address bits used to determine the start address of the corresponding memory address window. This provides a minimum 4 KB window for memory address window.

22.4.14 MEMWIDn_REG (Index: 0x11, 0x19, 0x21, 0x29, 0x31)

Remark n = 0 to 4

MEMWID0_REG (0x11): for Window 0 MEMWID3_REG (0x29): for Window 3
 MEMWID1_REG (0x19): for Window 1 MEMWID4_REG (0x31): for Window 4
 MEMWID2_REG (0x21): for Window 2

Bit	7	6	5	4	3	2	1	0
Name	DWIDTH	ZWSEN	MWSTART A25	MWSTART A24	MWSTART A23	MWSTART A22	MWSTART A21	MWSTART A20
R/W	R/W	R/W	R/W	R/W	R/W	R/W	R/W	R/W
Reset	0	0	0	0	0	0	0	0

Bit	Name	Function
7	DWIDTH	Memory card data width 0 : 8 bits 1 : 16 bits
6	ZWSEN	Zero wait state enable 0 : 8-bit memory access takes 7 clocks (4 wait states) 16 bit memory access takes 4 clocks (1 wait state) 1 : 8-bit memory access takes 3 clocks 16 bit memory access takes 3 clocks
5 to 0	MWSTARTA(25:20)	Memory window start address bit 25 to 20

This register defines the memory card data width, zero wait state enable, and high-order address bits used to determine the start address of the corresponding memory address window.

22.4.15 SYMEMELnREG (Index: 0x12, 0x1A, 0x22, 0x2A, 0x32)

Remark n = 0 to 4

SYMEMEL0REG (0x12): for Window 0

SYMEMEL1REG (0x1A): for Window 1

SYMEMEL2REG (0x22): for Window 2

SYMEMEL3REG (0x2A): for Window 3

SYMEMEL4REG (0x32): for Window 4

Bit	7	6	5	4	3	2	1	0
Name	MWSTOPA 19	MWSTOPA 18	MWSTOPA 17	MWSTOPA 16	MWSTOPA 15	MWSTOPA 14	MWSTOPA 13	MWSTOPA 12
R/W	R/W	R/W	R/W	R/W	R/W	R/W	R/W	R/W
Reset	0	0	0	0	0	0	0	0

Bit	Name	Function
7 to 0	MWSTOPA(19:12)	Memory window stop address bit 19 to 12

Low-order address bits used to determine the stop address of the corresponding memory address window.

22.4.16 MEMSELn_REG (Index: 0x13, 0x1B, 0x23, 0x2B, 0x33)

Remark n = 0 to 4

MEMSEL0_REG (0x13): for Window 0

MEMSEL1_REG (0x1B): for Window 1

MEMSEL2_REG (0x23): for Window 2

MEMSEL3_REG (0x2B): for Window 3

MEMSEL4_REG (0x33): for Window 4

Bit	7	6	5	4	3	2	1	0
Name	M16W1	M16W0	MWSTPA 25	MWSTPA 24	MWSTPA 23	MWSTPA 22	MWSTPA 21	MWSTPA 20
R/W	R/W	R/W	R/W	R/W	R/W	R/W	R/W	R/W
Reset	0	0	0	0	0	0	0	0

Bit	Name	Function
7, 6	M16W(1:0)	Memory window wait state select for 16-bit system accesses. If the CompactFlash card supports the WAIT signal, the CompactFlash Card generates wait states by asserting the WAIT signal. 00 : Standard 16-bit cycle 01 : 1 additional wait state 10 : 2 additional wait states 11 : 3 additional wait states
5 to 0	MWSTPA(25:20)	Memory window stop address bit 25 to 20

22.4.17 MEMOFFLnREG (Index: 0x14, 0x1C, 0x24, 0x2C, 0x34)

Remark n = 0 to 4

MEMOFFL0REG (0x14): for Window 0

MEMOFFL3REG (0x2C): for Window 3

MEMOFFL1REG (0x1C): for Window 1

MEMOFFL4REG (0x34): for Window 4

MEMOFFL2REG (0x24): for Window 2

Bit	7	6	5	4	3	2	1	0
Name	OFFSETA 19	OFFSETA 18	OFFSETA 17	OFFSETA 16	OFFSETA 15	OFFSETA 14	OFFSETA 13	OFFSETA 12
R/W	R/W	R/W	R/W	R/W	R/W	R/W	R/W	R/W
Reset	0	0	0	0	0	0	0	0

Bit	Name	Function
7 to 0	OFFSETA(19:12)	Low-order address bits which are added to the system address bit 19 to 12 to generate the memory address for the card.

22.4.18 MEMOFFHnREG (Index: 0x15, 0x1D, 0x25, 0x2D, 0x35)

Remark n = 0 to 4

MEMOFFH0REG (0x15): for Window 0

MEMOFFH3REG (0x2D): for Window 3

MEMOFFH1REG (0x1D): for Window 1

MEMOFFH4REG (0x35): for Window 4

MEMOFFH2REG (0x25): for Window 2

Bit	7	6	5	4	3	2	1	0
Name	WP	REG	OFFSETA 25	OFFSETA 24	OFFSETA 23	OFFSETA 22	OFFSETA 21	OFFSETA 20
R/W	R/W	R/W	R/W	R/W	R/W	R/W	R/W	R/W
Reset	0	0	0	0	0	0	0	0

Bit	Name	Function
7	WP	Write protect to the card through the corresponding system memory window 0 : Write operation allowed 1 : Write operation inhibited
6	REG	REG active 0 : Access to the system will result in common memory on the CompactFlash card being accessed. 1 : Access to the system will result in attribute memory on the CompactFlash card being accessed.
5 to 0	OFFSETA(25:20)	Card memory offset address bit 25 to 20. High-order address bits which are added to the system address bit 23 to 20 to generate the memory address for the card. Remark This is only meaningful when there is a carry from the card memory offset low-order address bits.

22.4.19 DTGENCLREG (Index: 0x16)

Bit	7	6	5	4	3	2	1	0
Name	Reserved	Reserved	SWCDINT	CDRSMEN	reserved	Reserved	CFGRSTEN	DLY16INH
R/W	R	R	W	R/W	R	R	R/W	R/W
Reset	0	0	0	0	0	0	0	0

Bit	Name	Function
7, 6	Reserved	0 is returned when read
5	SWCDINT	<p>Software card detect interrupt request</p> <p>1 : Generates software interrupt request</p> <p>This bit is valid when the CD_EN bit is set to 1 in the CRDSTATREG register. 0 is returned when read.</p> <p>The functionality and acknowledgment of this software interrupt request operates in the same way as those of the hardware-generated interrupt requests.</p> <p>The functionality of the hardware card detect or card status change interrupt request is not affected by the setting of this bit. If card detect or card status change from the previous state occurs on the CD1# and CD2# inputs, a hardware card detect or card status change interrupt request is generated.</p>
4	CDRSMEN	<p>Card detect resume enable</p> <p>1 : Enables notification of change on CD1# and CD2# inputs</p> <p>When this bit is set to 1, the RIO# signal (internal) goes from high to low and the CD_CHG bit in the CDSTCHGREG register is set to 1. The RIO# signal remains low until either a read or a write of 1 to the CD_CHG bit (acknowledge cycle), which causes the CD_CHG bit to be reset to 0 and the RIO# signal to go from low to high. The CD_EN bit must be set to 1 in the CRDSTATREG register in order to generate the RIO# signal.</p> <p>If the card status change is routed to any of the IRQ signals, the setting of this bit to 1 prevents IRQ from going active as a result of a hardware card detect status change. Once the resume software detects a card detect status change interrupt request from RIO# by reading the CDSTCHGREG register, it should initiate a software card detect change interrupt request so that the card detect change condition generates an active interrupt request on the IRQ signal.</p>
3, 2	Reserved	0 is returned when read
1	CFGRSTEN	<p>Configuration reset enable</p> <p>1 : Resets configuration registers on high level of both CD1# and CD2# inputs</p> <p>The registers involved are all I/O registers, all memory registers, ITGENCTREG register, and ADWINENREG register.</p>
0	DLY16INH	<p>16-bit memory delay inhibit</p> <p>0 : Falling edge of the control strobes #WE and #OE is delayed in synchronization with SYSCLK when a system memory window is set to be 16 bit by setting the DWIDTH bit in the MEMWID_REG register to 1</p> <p>1 : Falling edge of the control strobe is not synchronously delayed</p>

22.4.20 GLOCTRLREG (Index: 0x1E)

Bit	7	6	5	4	3	2	1	0
Name	Reserved	Reserved	Reserved	Reserved	Reserved	EXWRBK	Reserved	Reserved
R/W	R	R	R	R	R	R/W	R	R
Reset	0	0	0	0	0	0	0	0

Bit	Name	Function
7 to 3	Reserved	0 is returned when read
2	EXWRBK	Explicit write back card status change acknowledge 0 : The card status change interrupt request is acknowledged by reading the CDSTCHGREG register and the register bits are cleared upon a read 1 : An explicit write of 1 is performed to the CD_CHG bit in the CDSTCHGREG register which indicates an interrupt request condition
1, 0	Reserved	0 is returned when read

22.4.21 VOLTSENREG (Index: 0x1F)

Bit	7	6	5	4	3	2	1	0
Name	Reserved	Reserved	Reserved	Reserved	Reserved	Reserved	VS2	VS1
R/W	R	R	R	R	R	R	R	R
Reset	0	0	0	0	0	0	1	0

Bit	Name	Function
7 to 2	Reserved	0 is returned when read
1, 0	VS(2:1)	Voltage sense status These bits are read-only and hardwired to 10 binary since the Vr4181 has no voltage sense pins.

22.4.22 VOLTSELREG (Index: 0x2F)

Bit	7	6	5	4	3	2	1	0
Name	Reserved	Reserved	Reserved	Reserved	Reserved	Reserved	VCCEN1	VCCEN0
R/W	R	R	R	R	R	R	R/W	R/W
Reset	0	0	0	0	0	0	1	0

Bit	Name	Function
7 to 2	Reserved	0 is returned when read
1, 0	VCCEN(1:0)	Voltage select. These bits must be set to 10 binary. 10 : 3.3 V capable

[MEMO]

CHAPTER 23 LED CONTROL UNIT (LED)

This chapter describes LED operations and register settings.

23.1 General

LEDs are switched on and off at a regular interval. The interval can be set as programmable.

23.2 Register Set

The LED registers are listed below.

Table 23-1. LED Registers

Address	R/W	Register Symbol	Function
0x0B00 0240	R/W	LEDHTSREG	LED H Time Set register
0x0B00 0242	R/W	LEDLTSREG	LED L Time Set register
0x0B00 0248	R/W	LEDCNTREG	LED Control register
0x0B00 024A	R/W	LEDASTCREG	LED Auto Stop Time Count register
0x0B00 024C	R/W	LEDINTREG	LED Interrupt register

These registers are described in detail below.

23.2.1 LEDHTSREG (0x0B00 0240)

Bit	15	14	13	12	11	10	9	8
Name	Reserved	Reserved	Reserved	Reserved	Reserved	Reserved	Reserved	Reserved
R/W	R	R	R	R	R	R	R	R
RTCRST	0	0	0	0	0	0	0	0
Other resets	0	0	0	0	0	0	0	0

Bit	7	6	5	4	3	2	1	0
Name	Reserved	Reserved	Reserved	HTS4	HTS3	HTS2	HTS1	HTS0
R/W	R	R	R	R/W	R/W	R/W	R/W	R/W
RTCRST	0	0	0	1	0	0	0	0
Other resets	0	0	0	Note	Note	Note	Note	Note

Bit	Name	Function
15 to 5	Reserved	0 is returned when read
4 to 0	HTS(4:0)	Values compared to bits 15 to 11 of LED HL Time Count. 11111 : 1.9375 seconds : 10000 : 1 second : 01000 : 0.5 seconds : 00100 : 0.25 seconds : 00010 : 0.125 seconds 00001 : 0.0625 seconds 00000 : Prohibit

Note Previous value is retained.

This register is used to set the LED's ON time (high level width of LEDOUT#).

The ON time ranges from 0.0625 to 1.9375 seconds and can be set in 0.0625 second units. The initial value is 1 second.

This register must not be changed once the LEDENABLE bit of LEDCNTREG register has been set to 1 as "enable". The operation is not guaranteed if a change is made after that point.

23.2.2 LEDLTSREG (0x0B00 0242)

Bit	15	14	13	12	11	10	9	8
Name	Reserved	Reserved	Reserved	Reserved	Reserved	Reserved	Reserved	Reserved
R/W	R	R	R	R	R	R	R	R
RTCRST	0	0	0	0	0	0	0	0
Other resets	0	0	0	0	0	0	0	0

Bit	7	6	5	4	3	2	1	0
Name	Reserved	LTS6	LTS5	LTS4	LTS3	LTS2	LTS1	LTS0
R/W	R	R/W	R/W	R/W	R/W	R/W	R/W	R/W
RTCRST	0	0	1	0	0	0	0	0
Other resets	0	Note	Note	Note	Note	Note	Note	Note

Bit	Name	Function
15 to 7	Reserved	0 is returned when read
6 to 0	LTS(6:0)	Values compared to bits 17 to 11 of LED HL Time Count. 1111111 : 7.9375 seconds : 1000000 : 4 seconds : 0100000 : 2 seconds : 0010000 : 1 second : 0001000 : 0.5 seconds : 0000100 : 0.25 seconds : 0000010 : 0.125 seconds 0000001 : 0.0625 seconds 0000000 : Prohibit

Note Previous value is retained.

This register is used to set the LED's OFF time (low level width of LEDOUT#).

The OFF time ranges from 0.0625 to 7.9375 seconds and can be set in 0.0625 second units. It should be set by means of software. The initial value is 2 seconds.

This register must not be changed once the LEDENABLE bit of LEDCNTREG register has been set as "enable". The operation is not guaranteed if a change is made after that point.

23.2.3 LEDCNTREG (0x0B00 0248)

Bit	15	14	13	12	11	10	9	8
Name	Reserved	Reserved	Reserved	Reserved	Reserved	Reserved	Reserved	Reserved
R/W	R	R	R	R	R	R	R	R
RTCRST	0	0	0	0	0	0	0	0
Other resets	0	0	0	0	0	0	0	0

Bit	7	6	5	4	3	2	1	0
Name	Reserved	Reserved	Reserved	Reserved	Reserved	Reserved	LEDSTOP	LEDENABLE
R/W	R	R	R	R	R	R	R/W	R/W
RTCRST	0	0	0	0	0	0	1	0
Other resets	0	0	0	0	0	0	Note	Note

Bit	Name	Function
15 to 2	Reserved	0 is returned when read
1	LEDSTOP	LED ON/OFF auto stop setting 1 : ON 0 : OFF
0	LEDENABLE	LED ON/OFF (blink) setting 1 : Blink 0 : Do not blink

Note Previous value is retained.

This register is used to make various LED settings.

Caution When setting up LED activation, make sure that a value other than zero has already been set to the LEDHTSREG, LEDLTSREG, and LEDASTCREG registers. The operation is not guaranteed if zero is set to these registers.

23.2.4 LEDASTCREG (0x0B00 024A)

Bit	15	14	13	12	11	10	9	8
Name	ASTC15	ASTC14	ASTC13	ASTC12	ASTC11	ASTC10	ASTC9	ASTC8
R/W	R/W	R/W	R/W	R/W	R/W	R/W	R/W	R/W
RTCRST	0	0	0	0	0	1	0	0
Other resets	0	0	0	0	0	1	0	0

Bit	7	6	5	4	3	2	1	0
Name	ASTC7	ASTC6	ASTC5	ASTC4	ASTC3	ASTC2	ASTC1	ASTC0
R/W	R/W	R/W	R/W	R/W	R/W	R/W	R/W	R/W
RTCRST	1	0	1	1	0	0	0	0
Other resets	1	0	1	1	0	0	0	0

Bit	Name	Function
15 to :0	ASTC(15:0)	LED auto stop time count bit

This register is a 16-bit down counter that sets the number of ON/OFF times prior to automatic stopping of LED activation. The set value is read during a read. The initial setting is 1,200 times (ON/OFF pairs) in which each time includes one second of ON time and two seconds of OFF time.

The pair of operations in which the LED is switched ON once and OFF once is counted as "1" by this counter. The counter counts down from the set value and an LEDINT interrupt occurs when it reaches zero.

Caution Setting a zero to this register is prohibited. The operation is not guaranteed if zero is set to this register.

23.2.5 LEDINTREG (0x0B00 024C)

Bit	15	14	13	12	11	10	9	8
Name	Reserved	Reserved	Reserved	Reserved	Reserved	Reserved	Reserved	Reserved
R/W	R	R	R	R	R	R	R	R
RTCRST	0	0	0	0	0	0	0	0
Other resets	0	0	0	0	0	0	0	0

Bit	7	6	5	4	3	2	1	0
Name	Reserved	Reserved	Reserved	Reserved	Reserved	Reserved	Reserved	LEDINT
R/W	R	R	R	R	R	R	R	R/W
RTCRST	0	0	0	0	0	0	0	0
Other resets	0	0	0	0	0	0	0	0

Bit	Name	Function
15 to 1	Reserved	0 is returned when read
0	LEDINT	Auto stop interrupt request. Cleared to 0 when 1 is written. 1 : Yes 0 : No

This register indicates when an auto stop interrupt request has occurred.

An auto stop interrupt request occurs if “1” has already been set to the LEDSTOP bit and the LEDENABLE bit of LEDCNTREG register when LEDASTCREG register is cleared to “0”. When this interrupt occurs, the LEDSTOP bit and the LEDENABLE bit of LEDCNTREG register are both cleared to “0”.

23.3 Operation Flow

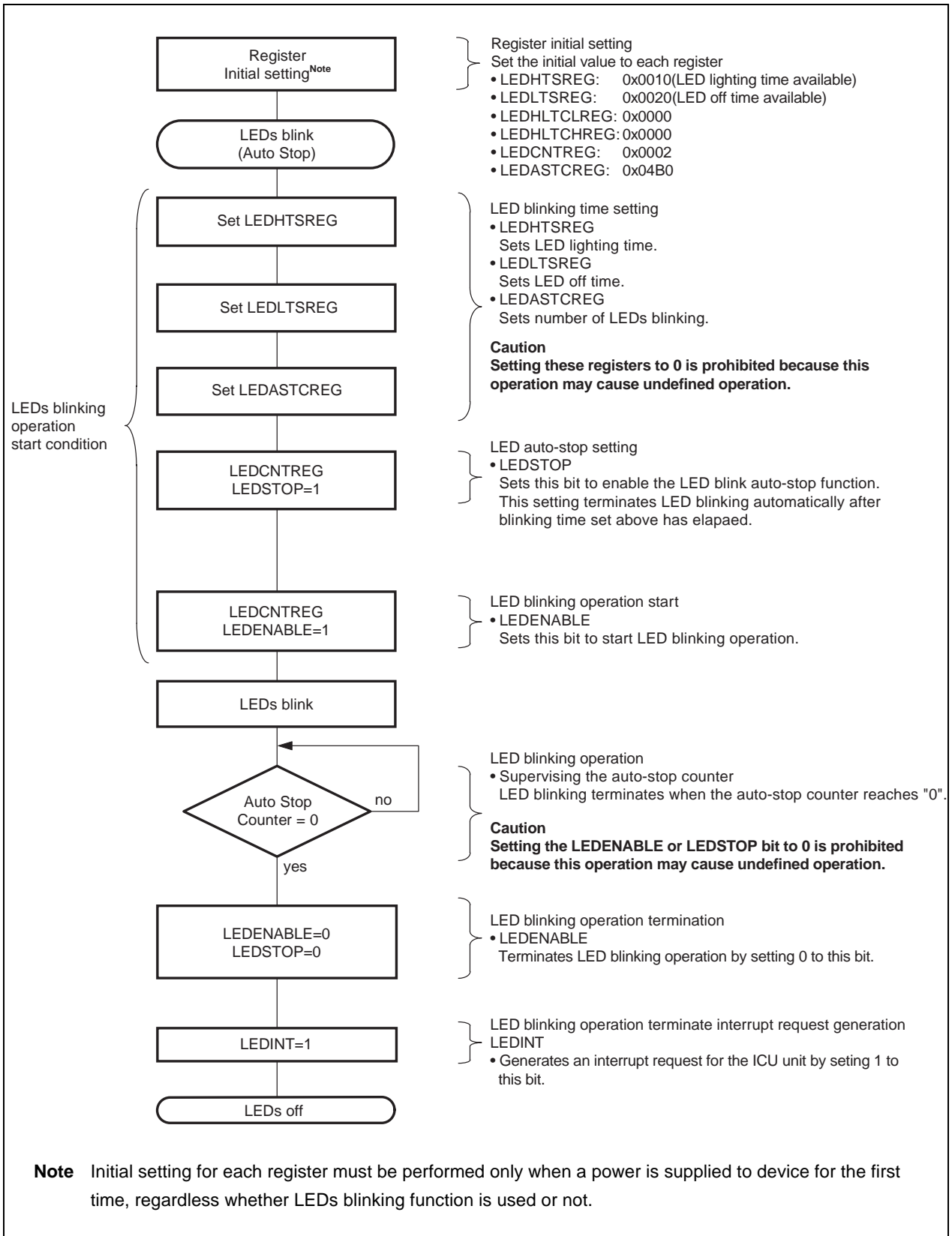

[MEMO]

CHAPTER 24 SERIAL INTERFACE UNIT 1 (SIU1)

This chapter describes the SIU1's operations and register settings.

24.1 General

The SIU1 is a serial interface that conforms to the RS-232-C communication standard and is equipped with two one-channel interfaces, one for transmission and one for reception.

This unit is functionally compatible with the NS16550 except additional clock control logic to permit the 16650 core clock source to be stopped.

Figure 24-1. SIU1 Block Diagram

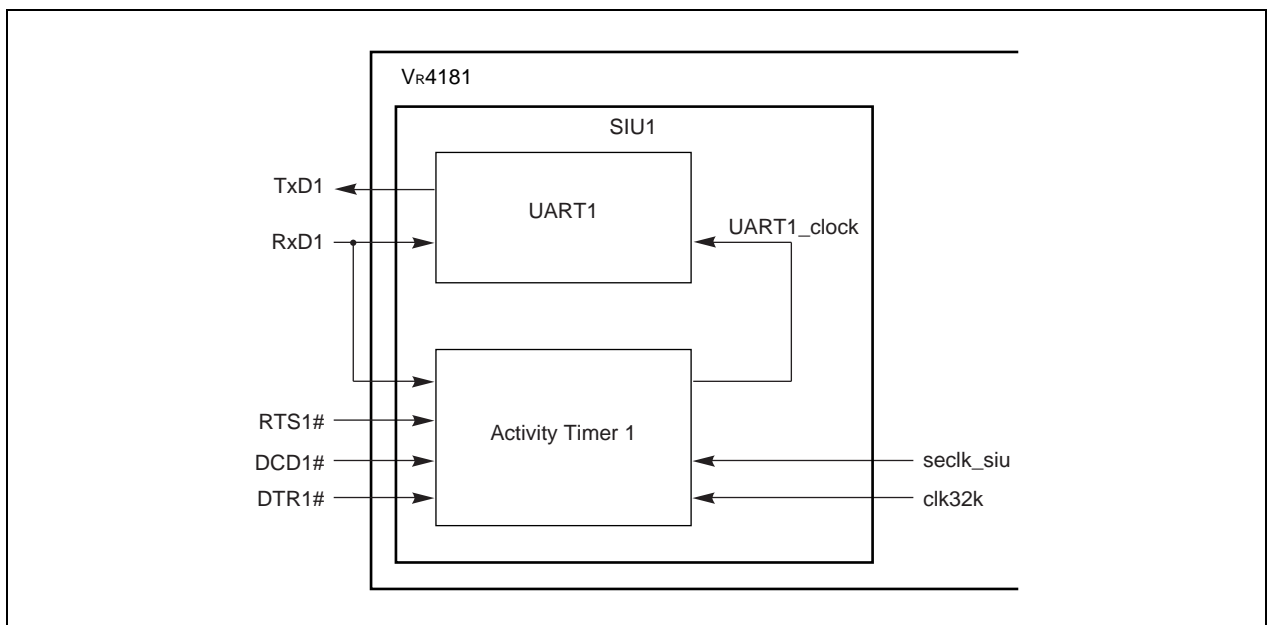

24.2 Clock Control Logic

The power of the 16550 core can be managed by monitoring activity on the modem status pins, the RxD1 pin, and writes to the transmit buffer.

The clock control logic for the 16550 core monitors activity on four serial interface input signals; RxD1, RTS1#, DCD1# and DTR1#. It also monitors writes to the 16550 transmit buffer. Each source has an associated mask bit which prevents that source from causing the Activity Timer to be reset.

Activity on the RxD1, RTS1#, DCD1# and DTR1# inputs is defined as any change of state (high to low or low to high). When no unmasked activity has been detected on any of the serial port inputs (RxD1, RTS1#, DCD1# and DTR1#), and no writes have occurred to the transmit buffer (TXWR) within the programmed time-out period specified by the Activity Timer block, then UART1_clock is stopped. UART1_clock will remain stopped until any of the activity sources is detected.

24.3 Register Set

The SIU1 registers are listed below.

Table 24-1. SIU1 Registers

Address	LCR7	R/W	Register symbol	Function
0x0C00 0010	0	R	SIURB_1	Receiver buffer register (read)
		W	SIUTH_1	Transmitter holding register (write)
	1	R/W	SIUDLL_1	Divisor latch (least significant byte)
0x0C00 0011	0	R/W	SIUIE_1	Interrupt enable
	1	R/W	SIUDLM_1	Divisor latch (most significant byte)
0x0C00 0012	—	R	SIUID_1	Interrupt identification register (read)
	—	W	SIUFC_1	FIFO control register (write)
0x0C00 0013	—	R/W	SIULC_1	Line control register
0x0C00 0014	—	R/W	SIUMC_1	MODEM control register
0x0C00 0015	—	R/W	SIULS_1	Line status register
0x0C00 0016	—	R/W	SIUMS_1	MODEM status register
0x0C00 0017	—	R/W	SIUSC_1	Scratch register
0x0C00 0019	—	R/W	SIURESET_1	SIU reset register
0x0C00 001C	—	R/W	SIUACTMSK_1	SIU activity mask register
0x0C00 001E	—	R/W	SIUADTTMR_1	SIU Activity Timer register

Remark LCR7 is the bit 7 of SIULC_1 register.

24.3.1 SIURB_1 (0x0C00 0010: LCR7 = 0, Read)

Bit	7	6	5	4	3	2	1	0
Name	RXD7	RXD6	RXD5	RXD4	RXD3	RXD2	RXD1	RXD0
R/W	R	R	R	R	R	R	R	R
RTCRST	0	0	0	0	0	0	0	0
Other resets	0	0	0	0	0	0	0	0

Bit	Name	Function
7 to 0	RXD(7:0)	Serial receive data

This register stores receive data used in serial communications.
To access this register, set LCR7 (bit 7 of SIULC_1 register) to 0.

24.3.2 SIUTH_1 (0x0C00 0010: LCR7 = 0, Write)

Bit	7	6	5	4	3	2	1	0
Name	TXD7	TXD6	TXD5	TXD4	TXD3	TXD2	TXD1	TXD0
R/W	W	W	W	W	W	W	W	W
RTCRST	0	0	0	0	0	0	0	0
Other resets	0	0	0	0	0	0	0	0

Bit	Name	Function
7 to 0	TXD(7:0)	Serial transmit data

This register stores transmit data used in serial communications.
To access this register, set LCR7 (bit 7 of SIULC_1 register) to 0.

24.3.3 SIUDLL_1 (0x0C00 0010: LCR7 = 1)

Bit	7	6	5	4	3	2	1	0
Name	DLL7	DLL6	DLL5	DLL4	DLL3	DLL2	DLL1	DLL0
R/W	R/W	R/W	R/W	R/W	R/W	R/W	R/W	R/W
RTCRST	0	0	0	0	0	0	0	0
Other resets	0	0	0	0	0	0	0	0

Bit	Name	Function
7 to 0	DLL(7:0)	Baud rate generator divisor (low-order byte)

This register is used to set the divisor (division rate) for the baud rate generator.
The data in this register and the upper 8-bit data in SIUDLM_1 register are together handled as 16-bit data.
To access this register, set LCR7 (bit 7 of SIULC_1 register) to 1.

24.3.4 SIUIE_1 (0x0C00 0011: LCR7 = 0)

Bit	7	6	5	4	3	2	1	0
Name	Reserved	Reserved	Reserved	Reserved	IE3	IE2	IE1	IE0
R/W	R	R	R	R	R/W	R/W	R/W	R/W
RTCRST	0	0	0	0	0	0	0	0
Other resets	0	0	0	0	0	0	0	0

Bit	Name	Function
7 to 4	Reserved	0 is returned when read
3	IE3	MODEM status interrupt 1 : Interrupt enable 0 : Interrupt prohibit
2	IE2	Receive status interrupt 1 : Interrupt enable 0 : Interrupt prohibit
1	IE1	Transmitter holding register empty interrupt 1 : Interrupt enable 0 : Interrupt prohibit
0	IE0	Receive data interrupt or timeout interrupt in FIFO mode 1 : Interrupt enable 0 : Interrupt prohibit

This register is used to specify interrupt enable/prohibit settings for the five types of interrupt requests used by SIU1.

These bits can be used to make the corresponding interrupt request output (INTR) active.

Overall use of interrupt functions can be halted by setting bits 0 to 3 of this register to 0.

When interrupts are prohibited, "pending" is not displayed in the IIR0 bit in the SIUID_1 register even when the interrupt condition has been met and INTR output does not become active.

Other functions in the system are not affected even though interrupts are prohibited and the settings in the line status register (SIULS_1) and MODEM status register (SIUMS_1) are valid.

To access this register, set LCR7 (bit 7 of SIULC_1 register) to 0.

24.3.5 SIUDLM_1 (0x0C00 0011: LCR7 = 1)

Bit	7	6	5	4	3	2	1	0
Name	DLM7	DLM6	DLM5	DLM4	DLM3	DLM2	DLM1	DLM0
R/W	R/W	R/W	R/W	R/W	R/W	R/W	R/W	R/W
RTCRST	0	0	0	0	0	0	0	0
Other resets	0	0	0	0	0	0	0	0

Bit	Name	Function
7 to 0	DLM(7:0)	Baud rate generator divisor (high-order byte)

This register is used to set the divisor (division rate) for the baud rate generator.
 The data in this register and the lower 8-bit data in SIUDLL_1 register are together handled as 16-bit data.
 To access this register, set LCR7 (bit 7 of SIULC_1 register) to 1.

Table 24-2. Correspondence between Baud Rates and Divisors

Baud rate	Divisor	1-clock width
50	23040	20000
75	15360	13333
110	10473	9091
134.5	8565	7435
150	7680	6667
300	3840	3333
600	1920	1667
1200	920	833
1800	640	556
2000	573	500
2400	480	417
3600	320	278
4800	240	208
7200	160	139
9600	120	104
19200	60	52.1
38400	30	26.0
56000	21	17.9
128000	9	7.81
144000	8	6.94
192000	6	5.21
230400	5	4.34
288000	4	3.47
384000	3	2.60
576000	2	1.74
1152000	1	0.868

24.3.6 SIUIID_1 (0x0C00 0012: Read)

Bit	7	6	5	4	3	2	1	0
Name	IIR7	IIR6	Reserved	Reserved	IIR3	IIR2	IIR1	IIR0
R/W	R	R	R	R	R	R	R	R
RTCRST	0	0	0	0	0	0	0	1
Other resets	0	0	0	0	0	0	0	1

Bit	Name	Function
7, 6	IIR(7:6)	Becomes 11 when FCR0 = 1
5, 4	Reserved	0 is returned when read
3	IIR3	Pending character timeout interrupt (in FIFO mode) 1 : No pending interrupt 0 : Pending interrupt
2, 1	IIR(2:1)	Indicates the priority level of pending interrupt. See the following table.
0	IIR0	Pending interrupts 1 : No pending interrupt 0 : Pending interrupt

This register indicates priority levels for interrupts and existence of pending interrupt.

From highest to lowest priority, these interrupts are receive line status, receive data ready, character timeout, transmit holding register empty, and MODEM status.

The contents of IIR3 bit are valid only in FIFO mode, and it is always 0 in 16450 mode.

IIR2 bit becomes 1 when IIR3 bit is set to 1.

Table 24-3. Interrupt Function

SIUID_1 register			Interrupt set/reset function			
Bit 3 ^{Note}	Bit 2	Bit 1	Priority level	Interrupt type	Interrupt source	Interrupt reset control
0	1	1	Highest (1st)	Receive line status	Overrun error, parity error, framing error, or break interrupt	Read line status register
0	1	0	2nd	Receive data ready	Receive data exists or has reached the trigger level.	Read the receive buffer register or lower trigger level via FIFO.
1	1	0	2nd	Character timeout	During the time period for the four most recent characters, not one character has been read from the receive FIFO nor has a character been input to the receive FIFO. During this period, at least one character has been held in the receive FIFO.	Read receive buffer register
0	0	1	3rd	Transmit holding register empty	Transmit register is empty	Read IIR (if it is the interrupt source) or write to transmit holding register
0	0	0	4th	MODEM status	CTS1#, DSR1#, or DCD1#	Read MODEM status register

Note FIFO mode only.

24.3.7 SIUFC_1 (0x0C00 0012: Write)

Bit	7	6	5	4	3	2	1	0
Name	FCR7	FCR6	Reserved	Reserved	FCR3	FCR2	FCR1	FCR0
R/W	W	W	R	R	W	W	W	W
RTCRST	0	0	0	0	0	0	0	0
Other resets	0	0	0	0	0	0	0	0

Bit	Name	Function
7, 6	FCR(7:6)	Receive FIFO trigger level 11 : 14 bytes 10 : 8 bytes 01 : 4 bytes 00 : 0 bytes
5, 4	Reserved	0 is returned when read
3	FCR3	Switch between 16450 mode and FIFO mode 1 : From 16450 mode to FIFO mode 0 : From FIFO mode to 16450 mode
2	FCR2	Transmit FIFO clear/counter clear. Cleared to 0 when 1 is written. 1 : FIFO clear/counter clear 0 : Normal
1	FCR1	Receive FIFO clear/counter clear. Cleared to 0 when 1 is written. 1 : FIFO clear/counter clear 0 : Normal
0	FCR0	Receive/Transmit FIFO enable 1 : Enable 0 : Disable

This register is used to control the FIFOs: enable FIFO, clear FIFO, and set the receive FIFO trigger level.

- **FIFO interrupt modes**

When receive FIFO is enabled and receive interrupts are enabled, receive interrupts can occur as described below.

1. When the FIFO is reached to the specified trigger level, a receive data ready interrupt occurs to inform the CPU.
This interrupt is cleared when the FIFO goes below the trigger level.
2. When the FIFO is reached to the specified trigger level, the SUIID_1 register indicates a receive data ready interrupt.
As with the interrupt above, SUIID_1 register is cleared when the FIFO goes below the trigger level.
3. Receive line status interrupts are assigned a higher priority level than are receive data ready interrupts.
4. When characters are transferred from the shift register to the receive FIFO, 1 is set to the LSR0 bit.
The value of this bit returns to 0 when the FIFO becomes empty.

When receive FIFO is enabled and receive interrupts are enabled, receive FIFO timeout interrupts can occur as described below.

1. The following are conditions under which FIFO timeout interrupts occur.
 - At least one character is being stored in the FIFO.
 - The time required for sending four characters has elapsed since the serial reception of the last character (includes the time for two stop bits in cases where a stop bit has been specified).
 - The time required for sending four characters has elapsed since the CPU last accessed the FIFO.

The time between receiving the last character and issuing a timeout interrupt is a maximum of 160 ms when operating at 300 baud and receiving 12-bit data.

2. The transfer time for a character is calculated based on the baud rate clock for reception (internal) input as clock signals (which is why the elapsed time is in proportion to the baud rate).
3. Once a timeout interrupt has occurred, the timeout interrupt is cleared and the timer is reset as soon as the CPU reads one character from the receive FIFO.
4. If no timeout interrupt has occurred, the timer is reset when a new character is received or when the CPU reads the receive FIFO.

When transmit FIFO is enabled and transmit interrupts are enabled, transmit interrupts can occur as described below.

1. When the transmit FIFO becomes empty, a transmit holding register empty interrupt occurs. This interrupt is cleared when a character is written to the transmit holding register (from one to 16 characters can be written to the transmit FIFO during servicing of this interrupt), or when interrupt ID register (SIUID_1) is read.
2. If there are not at least two bytes of character data in the transmit FIFO between one time when LSR5 = 1 (transmit FIFO is empty) and the next time when LSR5 = 1, empty transmit FIFO status is reported to the IIR bits after a delay period calculated as “the time for one character – the time for the last stop bit(s)”. When transmit interrupts are enabled, the first transmit interrupt that occurs after the FCR0 (FIFO enable bit) is overwritten is indicated immediately.

The priority level of the character timeout interrupt and receive FIFO trigger level interrupt is the same as that of the receive data ready interrupt.

The priority level of the transmit FIFO empty interrupt is the same as that of the transmit holding register empty interrupt.

Whether data to be transmitted exists or not in the transmit FIFO and the transmit shift register, check the transmit block empty bit (bit 6) of the SIULS_1 register. It cannot be checked by the transmit holding register empty bit (bit 5) of the SIULS_1 register, because this bit is used to check whether data to be transferred exists or not in the transmit FIFO. Therefore, this bit cannot check if there is data in the transmit shift register.

- **FIFO polling mode**

When FCR0 = 1 (FIFO is enabled), if the value of any or all of the interrupt enable register (SIUIE_1) bits 3 to 0 becomes 0, SIU1 enters FIFO polling mode. Because the transmit block and receive blocks are controlled separately, polling mode can be set for either or both blocks.

When in this mode, the status of the transmit block and/or receive block can be checked by reading the line status register (SIULS_1) via a user program.

When in the FIFO polling mode, there is no notification when the trigger level is reached or when a timeout occurs, but the receive FIFO and transmit FIFO can still store characters as they normally do.

24.3.8 SIULC_1 (0x0C00 0013)

Bit	7	6	5	4	3	2	1	0
Name	LCR7	LCR6	LCR5	LCR4	LCR3	LCR2	LCR1	LCR0
R/W	R/W	R/W	R/W	R/W	R/W	R/W	R/W	R/W
RTCRST	0	0	0	0	0	0	0	0
Other resets	0	0	0	0	0	0	0	0

Bit	Name	Function
7	LCR7	Divisor latch access bit specification (DLAB) 1 : Divisor latch access 0 : Receive buffer, transmit holding register, interrupt enable register
6	LCR6	Break control 1 : Set break 0 : Clear break
5	LCR5	Parity fixing 1 : Fixed parity 0 : Parity not fixed
4	LCR4	Parity setting 1 : Set one bit as even bit 0 : Set one bit as odd bit
3	LCR3	Parity enable 1 : Create parity (during transmission) or check parity (during reception) 0 : No parity (during transmission) or no checking (during reception)
2	LCR2	Stop bit specification 1 : 1.5 bits (character length is 5 bits) 2 bits (character length is 6, 7, or 8 bits) 0 : 1 bit
1, 0	LCR(1:0)	Specifies the length of one character (number of bits) 11 : 8 bits 10 : 7 bits 01 : 6 bits 00 : 5 bits

This register is used to specify the format for asynchronous communication and exchange and to set the divisor latch access bit.

Bit 6 is used to send the break status to the receive side's UART. When bit 6 = 1, the serial output (TxD1) is forcibly set to the spacing (0) state.

The setting of bit 5 becomes valid according to settings in bits 4 and 3.

24.3.9 SIUMC_1 (0x0C00 0014)

Bit	7	6	5	4	3	2	1	0
Name	Reserved	Reserved	Reserved	MCR4	MCR3	MCR2	MCR1	MCR0
R/W	R	R	R	R/W	R/W	R/W	R/W	R/W
RTCRST	0	0	0	0	0	0	0	0
Other resets	0	0	0	0	0	0	0	0

Bit	Name	Function
7 to 5	Reserved	0 is returned when read
4	MCR4	For diagnostic testing (local loopback) 1 : Enable use of local loopback 0 : Disable use of local loopback
3	MCR3	OUT2 signal (internal) specification 1 : Output the low level 0 : Output the high level
2	MCR2	OUT1 signal (internal) specification 1 : Output the low level 0 : Output the high level
1	MCR1	RTS1# output control 1 : Output the low level 0 : Output the high level
0	MCR0	DTR1# output control 1 : Output the low level 0 : Output the high level

This register is used for interface control with a modem or data set (or a peripheral device that emulates a modem).

The settings of bit 3 and bit 2 become valid only when bit 4 is set to 1 (enable use of local loopback).

• **Local Loopback**

The local loopback can be used to test the transmit/receive data path in SIU1.

The following operation (local loopback) is executed when bit 4 value = 1.

The transmit block's serial output (TxD1) enters the marking state (logical 1) and the serial input (RxD1) to the receive block is cut off. The transmit shift register's output is looped back to the receive shift register's input.

The four modem control inputs (DSR1#, CTS1#, RI (internal), and DCD1#) are cut off and the four modem control outputs (DTR1#, RTS1#, OUT1 (internal), and OUT2 (internal)) are internally connected to the corresponding modem control inputs.

The modem control output pins are forcibly set as inactive (high level). During this kind of loopback mode, transmitted data can be immediately and directly received.

This function can be used to check on the transmit/receive data bus within SIU1.

When in loopback mode, both transmission and receive interrupts can be used. The interrupt sources are external sources in relation to the transmit and receive blocks.

Although modem control interrupts can be used, the low-order four bits of the modem control register can be used instead of the four modem control inputs as interrupt sources.

As usual, each interrupt is controlled by an interrupt enable register.

24.3.10 SIULS_1 (0x0C00 0015)

Bit	7	6	5	4	3	2	1	0
Name	LSR7	LSR6	LSR5	LSR4	LSR3	LSR2	LSR1	LSR0
R/W	R/W	R/W	R/W	R/W	R/W	R/W	R/W	R/W
RTCRST	0	1	1	0	0	0	0	0
Other resets	0	1	1	0	0	0	0	0

Bit	Name	Function
7	LSR7	Error detection in (FIFO mode) 1 : Parity error, framing error, or break is detected in the FIFO. 0 : Normal
6	LSR6	Transmit block empty 1 : No data in transmit holding register or transmit shift register No data in transmit FIFO (during FIFO mode) 0 : Data exists in transmit holding register or transmit shift register Data exists in transmit FIFO (during FIFO mode)
5	LSR5	Transmit holding register empty 1 : Character is transferred to transmit shift register (during 16450 mode) Transmit FIFO is empty (during FIFO mode) 0 : Character is stored in transmit holding register (during 16450 mode) Transmit data exists in transmit FIFO (during FIFO mode)
4	LSR4	Break interrupt 1 : Break interrupt detected 0 : Normal
3	LSR3	Framing error 1 : Framing error detected 0 : Normal
2	LSR2	Parity error 1 : Parity error detected 0 : Normal
1	LSR1	Overrun error 1 : Overwrite receive data 0 : Normal
0	LSR0	Receive data ready 1 : Receive data exists in FIFO 0 : No receive data in FIFO

The CPU uses this register to get information related to data transfers.
When LSR7 and LSR(4:1) bits are 1, reading this register clears these bits to 0.

Caution The receive data ready bit (bit 0) is set before the serial data reception is completed. Therefore, the receive data ready bit may not be cleared if the serial receive data is read from the SIURB_1 register immediately after this bit is set.
When reading data from the SIURB_1 register, wait for the stop bit width time since the receive data ready bit is set.

LSR7 bit is valid only in FIFO mode, and it indicates always 0 in 16450 mode.

The value of LSR4 bit becomes 1 when the spacing mode (logical 0) is held longer than the time required for transmission of one word of receive data input (start bit + data bits + parity bit + stop bit).

This bit value returns 0 when the CPU reads the contents of the line status register. When in FIFO mode, if a break interrupt is detected for one character in the FIFO, the character is regarded as an error character and the CPU is notified of a break interrupt when that character reaches the highest position in the FIFO.

When a break occurs, one "zero" character is sent to the FIFO. The RxD1 enters marking mode, and when the next valid start bit is received, the next character can be transmitted.

The value of LSR3 bit becomes 1 when a zero (spacing level) stop bit is detected following the final data bit or parity bit. This bit value returns to 0 when the CPU reads the contents of the line status register.

When in FIFO mode, if a framing error is detected for one character in the FIFO, the character is regarded as an error character and the CPU is notified of a framing error when that character reaches the highest position in the FIFO.

When a framing error occurs, the SIU1 prepares for further synchronization. The next start bit is assumed to be the cause of the framing error and further data is not accepted until the next start bit has been sampled twice.

The value of LSR2 bit becomes 1 when a parity error is detected. This bit value returns to 0 when the CPU reads the contents of the line status register.

When in FIFO mode, if a parity error is detected for one character within the FIFO, the character is regarded as an error character and the CPU is notified of a parity error when that character reaches the highest position in the FIFO.

The value of LSR1 bit becomes 1 when overrun status is detected and returns to 0 when the CPU reads the contents of the line status register.

When in FIFO mode, if the data exceeds the trigger level as it continues to be transferred to the FIFO, even after the FIFO becomes full an overrun error will not occur until all characters are stored in the shift register.

The CPU is notified as soon as an overrun error occurs. The characters in the shift register are overwritten and are not transferred to the FIFO.

24.3.11 SIUMS_1 (0x0C00 0016)

Bit	7	6	5	4	3	2	1	0
Name	MSR7	MSR6	MSR5	MSR4	MSR3	MSR2	MSR1	MSR0
R/W	R	R	R	R	R/W	R/W	R/W	R/W
RTCRST	Undefined	Undefined	Undefined	Undefined	0	0	0	0
Other resets	Undefined	Undefined	Undefined	Undefined	0	0	0	0

Bit	Name	Function
7	MSR7	Complement of DCD1# signal 1 : High level 0 : Low level
6	MSR6	Complement of RI signal (internal) 1 : High level 0 : Low level
5	MSR5	Complement of DSR1# input 1 : High level 0 : Low level
4	MSR4	Complement of CTS1# input 1 : High level 0 : Low level
3	MSR3	DCD1# signal change 1 : Change in DCD1# signal 0 : No change
2	MSR2	RI signal (internal) change 1 : Change in RI signal (internal) 0 : No change
1	MSR1	DSR1# signal change 1 : Change in DSR1# signal 0 : No change
0	MSR0	CTS1# signal change 1 : Change in CTS1# signal 0 : No change

This register indicates the current status of various control signals that are input to the CPU from a modem or other peripheral device.

MSR(3:0) bits are cleared to 0 when they are read.

24.3.12 SIUSC_1 (0x0C00 0017)

Bit	7	6	5	4	3	2	1	0
Name	SCR7	SCR6	SCR5	SCR4	SCR3	SCR2	SCR1	SCR0
R/W	R/W	R/W	R/W	R/W	R/W	R/W	R/W	R/W
RTCRST	0	0	0	0	0	0	0	0
Other resets	0	0	0	0	0	0	0	0

Bit	Name	Function
7 to 0	SCR(7:0)	Can be freely applied by user

This register is a readable/writable 8-bit register, and can be used freely by users.
It does not affect control of the SIU1.

24.3.13 SIURESET_1 (0x0C00 0019)

Bit	7	6	5	4	3	2	1	0
Name	Reserved	Reserved	Reserved	Reserved	Reserved	Reserved	Reserved	SIU RESET
R/W	R	R	R	R	R	R	R	R/W
RTCRST	0	0	0	0	0	0	0	0
Other resets	0	0	0	0	0	0	0	0

Bit	Name	Function
7 to 1	Reserved	0 is returned when read
0	SIURESET	This bit is used to reset SIU1. 1: Reset SIU1 0: Release SIU1 reset

This register is used to reset SIU1 forcibly.

24.3.14 SIUACTMSK_1 (0x0C00 001C)

Bit	7	6	5	4	3	2	1	0
Name	Reserved	Reserved	RxDMSK	RTSMSK	DCDMSK	DTRMSK	Reserved	TxWRMSK
R/W	R	R	R/W	R/W	R/W	R/W	R	R/W
RTCRST	0	0	0	0	0	0	0	0
Other resets	0	0	0	0	0	0	0	0

Bit	Name	Function
7, 6	Reserved	0 is returned when read
5	RxDMSK	Receive data mask 1: Mask 0: Unmask
4	RTSMSK	Request to send mask 1: Mask 0: Unmask
3	DCDMSK	Data carrier detect mask 1: Mask 0: Unmask
2	DTRMSK	Data transmit ready mask 1: Mask 0: Unmask
1	Reserved	0 is returned when read
0	TxWRMSK	Transmit buffer write mask 1: Mask 0: Unmask

When 1 is set in this register, state transition of the corresponding signals or write to transmit buffer does not retrigger the Activity Timer of the SIU1.

24.3.15 SIUACTTMR_1 (0x0C00 001E)

Bit	7	6	5	4	3	2	1	0
Name	SIUTMO7	SIUTMO6	SIUTMO5	SIUTMO4	SIUTMO3	SIUTMO2	SIUTMO1	SIUTMO0
R/W	R/W	R/W	R/W	R/W	R/W	R/W	R/W	R/W
RTCRST	0	0	0	0	0	0	0	0
Other resets	0	0	0	0	0	0	0	0

Bit	Name	Function
7 to 0	SIUTMO(7:0)	SIU activity timeout period 11111111 : 255 x 30.5 μ s 11111110 : 254 x 30.5 μ s : 01111111 : 127 x 30.5 μ s : 00000001 : 30.5 μ s 00000000 : Activity Timer disabled

[MEMO]

CHAPTER 25 SERIAL INTERFACE UNIT 2 (SIU2)

This chapter describes the SIU2's operations and register settings.

25.1 General

The SIU2 is a serial interface that conforms to the RS-232-C communication standard and is equipped with two one-channel interfaces, one for transmission and one for reception.

This unit is functionally compatible with the NS16550 except additional clock control logic to permit the 16650 core clock source to be stopped.

Figure 25-1. SIU2 Block Diagram

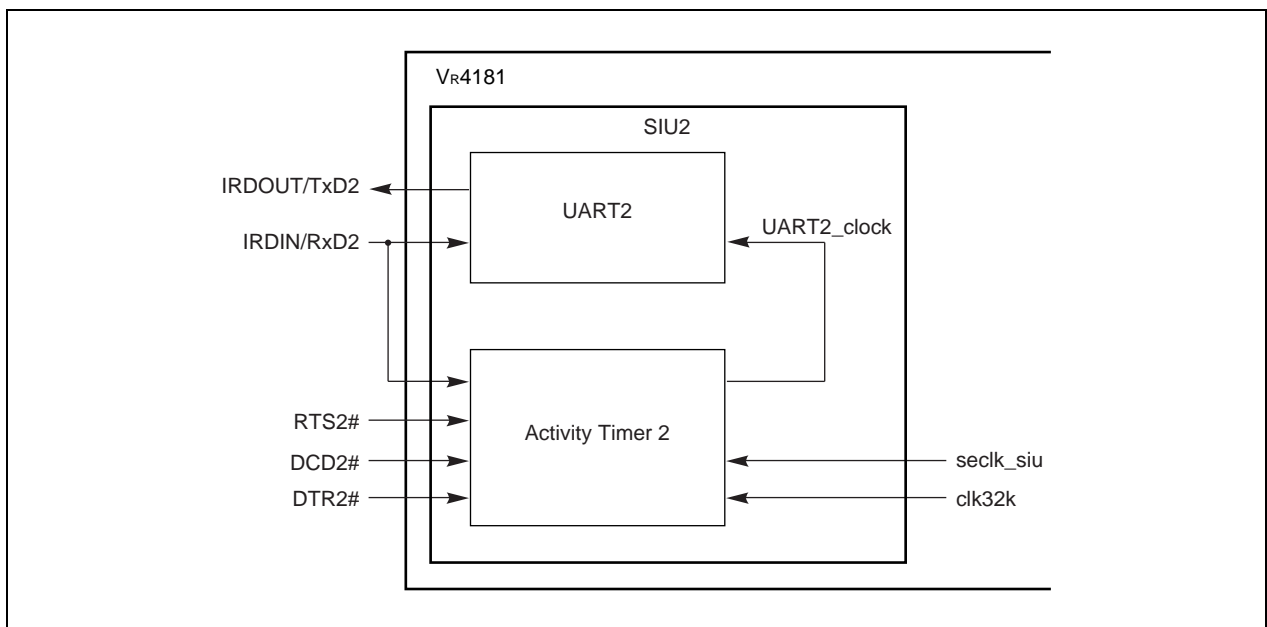

25.2 Clock Control Logic

The power of the 16550 core can be managed by monitoring activity on the modem status pins, the RxD2 pin, and writes to the transmit buffer.

The clock control logic for the 16550 core monitors activity on four serial interface input signals; RxD2, RTS2#, DCD2# and DTR2#. It also monitors writes to the 16550 transmit buffer. Each source has an associated mask bit which prevents that source from causing the Activity Timer to be reset.

Activity on the RxD2, RTS2#, DCD2# and DTR2# inputs is defined as any change of state (high to low or low to high). When no unmasked activity has been detected on any of the serial port inputs (RxD2, RTS2#, DCD2# and DTR2#), and no writes have occurred to the transmit buffer (TXWR) within the programmed time-out period specified by the Activity Timer block, then UART2_clock is stopped. UART2_clock will remain stopped until any of the activity sources is detected.

25.3 Register Set

The SIU2 registers are listed below.

Table 25-1. SIU2 Registers

Address	LCR7	R/W	Register Symbol	Function
0x0C00 0000	0	R	SIURB_2	Receiver buffer register (read)
		W	SIUTH_2	Transmitter holding register (write)
	1	R/W	SIUDLL_2	Divisor latch (least significant byte)
0x0C00 0001	0	R/W	SIUIE_2	Interrupt enable
	1	R/W	SIUDLM_2	Divisor latch (most significant byte)
0x0C00 0002	—	R	SIUIID_2	Interrupt identification register (read)
	—	W	SIUFC_2	FIFO control register (write)
0x0C00 0003	—	R/W	SIULC_2	Line control register
0x0C00 0004	—	R/W	SIUMC_2	MODEM control register
0x0C00 0005	—	R/W	SIULS_2	Line status register
0x0C00 0006	—	R/W	SIUMS_2	MODEM status register
0x0C00 0007	—	R/W	SIUSC_2	Scratch register
0x0C00 0008	—	R/W	SIURSEL_2	SIU IrDA selector
0x0C00 0009	—	R/W	SIURESET_2	SIU reset register
0x0C00 000A	—	R/W	SIUCSEL_2	SIU echo-back control register
0x0C00 000C	—	R/W	SIUACTMSK_2	SIU activity mask register
0x0C00 000E	—	R/W	SIUADTTMR_2	SIU Activity Timer register

Remark LCR7 is the bit 7 of SIULC_2 register.

25.3.1 SIURB_2 (0x0C00 0000: LCR7 = 0, Read)

Bit	7	6	5	4	3	2	1	0
Name	RXD7	RXD6	RXD5	RXD4	RXD3	RXD2	RXD1	RXD0
R/W	R	R	R	R	R	R	R	R
RTCRST	0	0	0	0	0	0	0	0
Other resets	0	0	0	0	0	0	0	0

Bit	Name	Function
7 to 0	RXD(7:0)	Serial receive data

This register stores receive data used in serial communications.
 To access this register, set LCR7 (bit 7 of SIULC_2 register) to 0.

25.3.2 SIUTH_2 (0x0C00 0000: LCR7 = 0, Write)

Bit	7	6	5	4	3	2	1	0
Name	TXD7	TXD6	TXD5	TXD4	TXD3	TXD2	TXD1	TXD0
R/W	W	W	W	W	W	W	W	W
RTCRST	0	0	0	0	0	0	0	0
Other resets	0	0	0	0	0	0	0	0

Bit	Name	Function
7 to 0	TXD(7:0)	Serial transmit data

This register stores transmit data used in serial communications.
 To access this register, set LCR7 (bit 7 of SIULC_2 register) to 0.

25.3.3 SIUDLL_2 (0x0C00 0000: LCR7 = 1)

Bit	7	6	5	4	3	2	1	0
Name	DLL7	DLL6	DLL5	DLL4	DLL3	DLL2	DLL1	DLL0
R/W	R/W	R/W	R/W	R/W	R/W	R/W	R/W	R/W
RTCRST	0	0	0	0	0	0	0	0
Other resets	0	0	0	0	0	0	0	0

Bit	Name	Function
7 to 0	DLL(7:0)	Baud rate generator divisor (low-order byte)

This register is used to set the divisor (division rate) for the baud rate generator.
 The data in this register and the upper 8-bit data in SIUDLM_2 register are together handled as 16-bit data.
 To access this register, set LCR7 (bit 7 of SIULC_2 register) to 1.

25.3.4 SIUIE_2 (0x0C00 0001: LCR7 = 0)

Bit	7	6	5	4	3	2	1	0
Name	Reserved	Reserved	Reserved	Reserved	IE3	IE2	IE1	IE0
R/W	R	R	R	R	R/W	R/W	R/W	R/W
RTCRST	0	0	0	0	0	0	0	0
Other resets	0	0	0	0	0	0	0	0

Bit	Name	Function
7 to 4	Reserved	0 is returned when read
3	IE3	MODEM status interrupt 1 : Interrupt enable 0 : Interrupt prohibit
2	IE2	Receive status interrupt 1 : Interrupt enable 0 : Interrupt prohibit
1	IE1	Transmitter holding register empty interrupt 1 : Interrupt enable 0 : Interrupt prohibit
0	IE0	Receive data interrupt or timeout interrupt in FIFO mode 1 : Interrupt enable 0 : Interrupt prohibit

This register is used to specify interrupt enable/prohibit settings for the five types of interrupt requests used by SIU2.

These bits can be used to make the corresponding interrupt request output (INTR) active.

Overall use of interrupt functions can be halted by setting bits 0 to 3 of this register to 0.

When interrupts are prohibited, "pending" is not displayed in the IIR0 bit in the SIUID_2 register even when the interrupt condition has been met and INTR output does not become active.

Other functions in the system are not affected even though interrupts are prohibited and the settings in the line status register (SIULS_2) and MODEM status register (SIUMS_2) are valid.

To access this register, set LCR7 (bit 7 of SIULC_2 register) to 0.

25.3.5 SIUDLM_2 (0x0C00 0001: LCR7 = 1)

Bit	7	6	5	4	3	2	1	0
Name	DLM7	DLM6	DLM5	DLM4	DLM3	DLM2	DLM1	DLM0
R/W	R/W	R/W	R/W	R/W	R/W	R/W	R/W	R/W
RTCRST	0	0	0	0	0	0	0	0
Other resets	0	0	0	0	0	0	0	0

Bit	Name	Function
7 to 0	DLM(7:0)	Baud rate generator divisor (high-order byte)

This register is used to set the divisor (division rate) for the baud rate generator.
 The data in this register and the lower 8-bit data in SIUDLL_2 register are together handled as 16-bit data.
 To access this register, set LCR7 (bit 7 of SIULC_2 register) to 1.

Table 25-2. Correspondence between Baud Rates and Divisors

Baud rate	Divisor	1-clock width
50	23040	20000
75	15360	13333
110	10473	9091
134.5	8565	7435
150	7680	6667
300	3840	3333
600	1920	1667
1200	920	833
1800	640	556
2000	573	500
2400	480	417
3600	320	278
4800	240	208
7200	160	139
9600	120	104
19200	60	52.1
38400	30	26.0
56000	21	17.9
128000	9	7.81
144000	8	6.94
192000	6	5.21
230400	5	4.34
288000	4	3.47
384000	3	2.60
576000	2	1.74
1152000	1	0.868

25.3.6 SIUIID_2 (0x0C00 0002: Read)

Bit	7	6	5	4	3	2	1	0
Name	IIR7	IIR6	Reserved	Reserved	IIR3	IIR2	IIR1	IIR0
R/W	R	R	R	R	R	R	R	R
RTCRST	0	0	0	0	0	0	0	1
Other resets	0	0	0	0	0	0	0	1

Bit	Name	Function
7, 6	IIR(7:6)	Becomes 11 when FCR0 = 1
5, 4	Reserved	0 is returned when read
3	IIR3	Pending character timeout interrupt (in FIFO mode) 1 : No pending interrupt 0 : Pending interrupt
2, 1	IIR(2:1)	Indicates the priority level of pending interrupt. See the following table.
0	IIR0	Pending interrupts 1 : No pending interrupt 0 : Pending interrupt

This register indicates priority levels for interrupts and existence of pending interrupt.

From highest to lowest priority, these interrupts are receive line status, receive data ready, character timeout, transmit holding register empty, and MODEM status.

The contents of IIR3 bit are valid only in FIFO mode, and it is always 0 in 16450 mode.

IIR2 bit becomes 1 when IIR3 bit is set to 1.

Table 25-3. Interrupt Function

SIUID_2 register			Interrupt set/reset function			
Bit 3 ^{Note}	Bit 2	Bit 1	Priority level	Interrupt type	Interrupt source	Interrupt reset control
0	1	1	Highest (1st)	Receive line status	Overrun error, parity error, framing error, or break interrupt	Read line status register
0	1	0	2nd	Receive data ready	Receive data exists or has reached the trigger level.	Read the receive buffer register or lower trigger level via FIFO.
1	1	0	2nd	Character timeout	During the time period for the four most recent characters, not one character has been read from the receive FIFO nor has a character been input to the receive FIFO. During this period, at least one character has been held in the receive FIFO.	Read receive buffer register
0	0	1	3rd	Transmit holding register empty	Transmit register is empty	Read IIR (if it is the interrupt source) or write to transmit holding register
0	0	0	4th	MODEM status	CTS2#, DSR2#, or DCD2#	Read MODEM status register

Note FIFO mode only.

25.3.7 SIUFC_2 (0x0C00 0002: Write)

Bit	7	6	5	4	3	2	1	0
Name	FCR7	FCR6	Reserved	Reserved	FCR3	FCR2	FCR1	FCR0
R/W	W	W	R	R	W	W	W	W
RTCRST	0	0	0	0	0	0	0	0
Other resets	0	0	0	0	0	0	0	0

Bit	Name	Function
7, 6	FCR(7:6)	Receive FIFO trigger level 11 : 14 bytes 10 : 8 bytes 01 : 4 bytes 00 : 0 bytes
5, 4	Reserved	0 is returned when read
3	FCR3	Switch between 16450 mode and FIFO mode 1 : From 16450 mode to FIFO mode 0 : From FIFO mode to 16450 mode
2	FCR2	Transmit FIFO clear/counter clear. Cleared to 0 when 1 is written. 1 : FIFO clear/counter clear 0 : Normal
1	FCR1	Receive FIFO clear/counter clear. Cleared to 0 when 1 is written. 1 : FIFO clear/counter clear 0 : Normal
0	FCR0	Receive/Transmit FIFO enable 1 : Enable 0 : Disable

This register is used to control the FIFOs: enable FIFO, clear FIFO, and set the receive FIFO trigger level.

- **FIFO interrupt modes**

When receive FIFO is enabled and receive interrupts are enabled, receive interrupts can occur as described below.

1. When the FIFO is reached to the specified trigger level, a receive data ready interrupt occurs to inform the CPU.
This interrupt is cleared when the FIFO goes below the trigger level.
2. When the FIFO is reached to the specified trigger level, the SUIID_2 register indicates a receive data ready interrupt.
As with the interrupt above, SUIID_2 register is cleared when the FIFO goes below the trigger level.
3. Receive line status interrupts are assigned a higher priority level than are receive data ready interrupts.
4. When characters are transferred from the shift register to the receive FIFO, 1 is set to the LSR0 bit.
The value of this bit returns to 0 when the FIFO becomes empty.

When receive FIFO is enabled and receive interrupts are enabled, receive FIFO timeout interrupts can occur as described below.

1. The following are conditions under which FIFO timeout interrupts occur.
 - At least one character is being stored in the FIFO.
 - The time required for sending four characters has elapsed since the serial reception of the last character (includes the time for two stop bits in cases where a stop bit has been specified).
 - The time required for sending four characters has elapsed since the CPU last accessed the FIFO.

The time between receiving the last character and issuing a timeout interrupt is a maximum of 160 ms when operating at 300 baud and receiving 12-bit data.

2. The transfer time for a character is calculated based on the baud rate clock for reception (internal) input as clock signals (which is why the elapsed time is in proportion to the baud rate).
3. Once a timeout interrupt has occurred, the timeout interrupt is cleared and the timer is reset as soon as the CPU reads one character from the receive FIFO.
4. If no timeout interrupt has occurred, the timer is reset when a new character is received or when the CPU reads the receive FIFO.

When transmit FIFO is enabled and transmit interrupts are enabled, transmit interrupts can occur as described below.

1. When the transmit FIFO becomes empty, a transmit holding register empty interrupt occurs. This interrupt is cleared when a character is written to the transmit holding register (from one to 16 characters can be written to the transmit FIFO during servicing of this interrupt), or when interrupt ID register (SIUID_2) is read.
2. If there are not at least two bytes of character data in the transmit FIFO between one time when LSR5 = 1 (transmit FIFO is empty) and the next time when LSR5 = 1, empty transmit FIFO status is reported to the IIR bits after a delay period calculated as “the time for one character – the time for the last stop bit(s)”. When transmit interrupts are enabled, the first transmit interrupt that occurs after the FCR0 (FIFO enable bit) is overwritten is indicated immediately.

The priority level of the character timeout interrupt and receive FIFO trigger level interrupt is the same as that of the receive data ready interrupt.

The priority level of the transmit FIFO empty interrupt is the same as that of the transmit holding register empty interrupt.

Whether data to be transmitted exists or not in the transmit FIFO and the transmit shift register, check the transmit block empty bit (bit 6) of the SIULS_2 register. It cannot be checked by the transmit holding register empty bit (bit 5) of the SIULS_2 register, because this bit is used to check whether data to be transferred exists or not in the transmit FIFO. Therefore, this bit cannot check if there is data in the transmit shift register.

- **FIFO polling mode**

When FCR0 = 1 (FIFO is enabled), if the value of any or all of the interrupt enable register (SIUIE_2) bits 3 to 0 becomes 0, SIU2 enters FIFO polling mode. Because the transmit block and receive blocks are controlled separately, polling mode can be set for either or both blocks.

When in this mode, the status of the transmit block and/or receive block can be checked by reading the line status register (SIULS_2) via a user program.

When in the FIFO polling mode, there is no notification when the trigger level is reached or when a timeout occurs, but the receive FIFO and transmit FIFO can still store characters as they normally do.

25.3.8 SIULC_2 (0x0C00 0003)

Bit	7	6	5	4	3	2	1	0
Name	LCR7	LCR6	LCR5	LCR4	LCR3	LCR2	LCR1	LCR0
R/W	R/W	R/W	R/W	R/W	R/W	R/W	R/W	R/W
RTCRST	0	0	0	0	0	0	0	0
Other resets	0	0	0	0	0	0	0	0

Bit	Name	Function
7	LCR7	Divisor latch access bit specification (DLAB) 1 : Divisor latch access 0 : Receive buffer, transmit holding register, interrupt enable register
6	LCR6	Break control 1 : Set break 0 : Clear break
5	LCR5	Parity fixing 1 : Fixed parity 0 : Parity not fixed
4	LCR4	Parity setting 1 : Set one bit as even bit 0 : Set one bit as odd bit
3	LCR3	Parity enable 1 : Create parity (during transmission) or check parity (during reception) 0 : No parity (during transmission) or no checking (during reception)
2	LCR2	Stop bit specification 1 : 1.5 bits (character length is 5 bits) 2 bits (character length is 6, 7, or 8 bits) 0 : 1 bit
1, 0	LCR(1:0)	Specifies the length of one character (number of bits) 11 : 8 bits 10 : 7 bits 01 : 6 bits 00 : 5 bits

This register is used to specify the format for asynchronous communication and exchange and to set the divisor latch access bit.

Bit 6 is used to send the break status to the receive side's UART. When bit 6 = 1, the serial output (TxD2) is forcibly set to the spacing (0) state.

The setting of bit 5 becomes valid according to settings in bits 4 and 3.

25.3.9 SIUMC_2 (0x0C00 0004)

Bit	7	6	5	4	3	2	1	0
Name	Reserved	Reserved	Reserved	MCR4	MCR3	MCR2	MCR1	MCR0
R/W	R	R	R	R/W	R/W	R/W	R/W	R/W
RTCRST	0	0	0	0	0	0	0	0
Other resets	0	0	0	0	0	0	0	0

Bit	Name	Function
7 to 5	Reserved	0 is returned when read
4	MCR4	For diagnostic testing (local loopback) 1 : Enable use of local loopback 0 : Disable use of local loopback
3	MCR3	OUT2 signal (internal) specification 1 : Output the low level 0 : Output the high level
2	MCR2	OUT1 signal (internal) specification 1 : Output the low level 0 : Output the high level
1	MCR1	RTS2# output control 1 : Output the low level 0 : Output the high level
0	MCR0	DTR2# output control 1 : Output the low level 0 : Output the high level

This register is used for interface control with a modem or data set (or a peripheral device that emulates a modem).

The settings of bit 3 and bit 2 become valid only when bit 4 is set to 1 (enable use of local loopback).

• **Local Loopback**

The local loopback can be used to test the transmit/receive data path in SIU2.

The following operation (local loopback) is executed when bit 4 value = 1.

The transmit block's serial output (TxD2) enters the marking state (logical 1) and the serial input (RxD2) to the receive block is cut off. The transmit shift register's output is looped back to the receive shift register's input.

The four modem control inputs (DSR2#, CTS2#, RI (internal), and DCD2#) are cut off and the four modem control outputs (DTR2#, RTS2#, OUT1 (internal), and OUT2 (internal)) are internally connected to the corresponding modem control inputs.

The modem control output pins are forcibly set as inactive (high level). During this kind of loopback mode, transmitted data can be immediately and directly received.

This function can be used to check on the transmit/receive data bus within SIU2.

When in loopback mode, both transmission and receive interrupts can be used. The interrupt sources are external sources in relation to the transmit and receive blocks.

Although modem control interrupts can be used, the low-order four bits of the modem control register can be used instead of the four modem control inputs as interrupt sources.

As usual, each interrupt is controlled by an interrupt enable register.

25.3.10 SIULS_2 (0x0C00 0005)

Bit	7	6	5	4	3	2	1	0
Name	LSR7	LSR6	LSR5	LSR4	LSR3	LSR2	LSR1	LSR0
R/W	R/W	R/W	R/W	R/W	R/W	R/W	R/W	R/W
RTCRST	0	1	1	0	0	0	0	0
Other resets	0	1	1	0	0	0	0	0

Bit	Name	Function
7	LSR7	Error detection in (FIFO mode) 1 : Parity error, framing error, or break is detected in the FIFO. 0 : Normal
6	LSR6	Transmit block empty 1 : No data in transmit holding register or transmit shift register No data in transmit FIFO (during FIFO mode) 0 : Data exists in transmit holding register or transmit shift register Data exists in transmit FIFO (during FIFO mode)
5	LSR5	Transmit holding register empty 1 : Character is transferred to transmit shift register (during 16450 mode) Transmit FIFO is empty (during FIFO mode) 0 : Character is stored in transmit holding register (during 16450 mode) Transmit data exists in transmit FIFO (during FIFO mode)
4	LSR4	Break interrupt 1 : Break interrupt detected 0 : Normal
3	LSR3	Framing error 1 : Framing error detected 0 : Normal
2	LSR2	Parity error 1 : Parity error detected 0 : Normal
1	LSR1	Overrun error 1 : Overwrite receive data 0 : Normal
0	LSR0	Receive data ready 1 : Receive data exists in FIFO 0 : No receive data in FIFO

The CPU uses this register to get information related to data transfers.

When LSR7 and LSR(4:1) bits are 1, reading this register clears these bits to 0.

Caution The receive data ready bit (bit 0) is set before the serial data reception is completed. Therefore, the receive data ready bit may not be cleared if the serial receive data is read from the SIURB_2 register immediately after this bit is set.

When reading data from the SIURB_2 register, wait for the stop bit width time since the receive data ready bit is set.

LSR7 bit is valid only in FIFO mode, and it indicates always 0 in 16450 mode.

The value of LSR4 bit becomes 1 when the spacing mode (logical 0) is held longer than the time required for transmission of one word of receive data input (start bit + data bits + parity bit + stop bit).

This bit value returns 0 when the CPU reads the contents of the line status register. When in FIFO mode, if a break interrupt is detected for one character in the FIFO, the character is regarded as an error character and the CPU is notified of a break interrupt when that character reaches the highest position in the FIFO.

When a break occurs, one "zero" character is sent to the FIFO. The RxD2 enters marking mode, and when the next valid start bit is received, the next character can be transmitted.

The value of LSR3 bit becomes 1 when a zero (spacing level) stop bit is detected following the final data bit or parity bit. This bit value returns to 0 when the CPU reads the contents of the line status register.

When in FIFO mode, if a framing error is detected for one character in the FIFO, the character is regarded as an error character and the CPU is notified of a framing error when that character reaches the highest position in the FIFO.

When a framing error occurs, the SIU2 prepares for further synchronization. The next start bit is assumed to be the cause of the framing error and further data is not accepted until the next start bit has been sampled twice.

The value of LSR2 bit becomes 1 when a parity error is detected. This bit value returns to 0 when the CPU reads the contents of the line status register.

When in FIFO mode, if a parity error is detected for one character within the FIFO, the character is regarded as an error character and the CPU is notified of a parity error when that character reaches the highest position in the FIFO.

The value of LSR1 bit becomes 1 when overrun status is detected and returns to 0 when the CPU reads the contents of the line status register.

When in FIFO mode, if the data exceeds the trigger level as it continues to be transferred to the FIFO, even after the FIFO becomes full an overrun error will not occur until all characters are stored in the shift register.

The CPU is notified as soon as an overrun error occurs. The characters in the shift register are overwritten and are not transferred to the FIFO.

25.3.11 SIUMS_2 (0x0C00 0006)

Bit	7	6	5	4	3	2	1	0
Name	MSR7	MSR6	MSR5	MSR4	MSR3	MSR2	MSR1	MSR0
R/W	R	R	R	R	R/W	R/W	R/W	R/W
RTCRST	Undefined	Undefined	Undefined	Undefined	0	0	0	0
Other resets	Undefined	Undefined	Undefined	Undefined	0	0	0	0

Bit	Name	Function
7	MSR7	Complement of DCD2# signal 1 : High level 0 : Low level
6	MSR6	Complement of RI signal (internal) 1 : High level 0 : Low level
5	MSR5	Complement of DSR2# input 1 : High level 0 : Low level
4	MSR4	Complement of CTS2# input 1 : High level 0 : Low level
3	MSR3	DCD2# signal change 1 : Change in DCD2# signal 0 : No change
2	MSR2	RI signal (internal) change 1 : Change in RI signal (internal) 0 : No change
1	MSR1	DSR2# signal change 1 : Change in DSR2# signal 0 : No change
0	MSR0	CTS2# signal change 1 : Change in CTS2# signal 0 : No change

This register indicates the current status of various control signals that are input to the CPU from a modem or other peripheral device.

MSR(3:0) bits are cleared to 0 when they are read.

25.3.12 SIUSC_2 (0x0C00 0007)

Bit	7	6	5	4	3	2	1	0
Name	SCR7	SCR6	SCR5	SCR4	SCR3	SCR2	SCR1	SCR0
R/W	R/W	R/W	R/W	R/W	R/W	R/W	R/W	R/W
RTCRST	0	0	0	0	0	0	0	0
Other resets	0	0	0	0	0	0	0	0

Bit	Name	Function
7 to 0	SCR(7:0)	Can be freely applied by user

This register is a readable/writable 8-bit register, and can be used freely by users.
It does not affect control of the SIU2.

25.3.13 SIURSEL_2 (0x0C00 0008)

Bit	7	6	5	4	3	2	1	0
Name	Reserved	Reserved	Reserved	Reserved	Reserved	Reserved	Reserved	SIRSEL
R/W	R	R	R/W	R	R/W	R/W	R	R/W
RTCRST	0	0	0	0	0	0	0	0
Other resets	0	0	0	0	0	0	0	0

Bit	Name	Function
7, 6	Reserved	0 is returned when read
5	Reserved	Write 0 when write. 0 is returned when read.
4	Reserved	0 is returned when read
3, 2	Reserved	Write 0 when write. 0 is returned when read.
0	SIRSEL	Selects whether the SIU2 uses the IrDA module or the RS-232-C pins during communications 1 : Use IrDA module 0 : Use RS-232-C interface

This register is used to set the SIU2's communication format (IrDA or RS-232-C).

25.3.14 SIURESET_2 (0x0C00 0009)

Bit	7	6	5	4	3	2	1	0
Name	Reserved	Reserved	Reserved	Reserved	Reserved	Reserved	Reserved	SIU RESET
R/W	R	R	R	R	R	R	R	R/W
RTCRST	0	0	0	0	0	0	0	0
Other resets	0	0	0	0	0	0	0	0

Bit	Name	Function
7 to 1	Reserved	0 is returned when read
0	SIURESET	This bit is used to reset SIU2. 1: Reset SIU2 0: Release SIU2 reset

This register is used to reset SIU2 forcibly.

25.3.15 SIUCSEL_2 (0x0C00 000A)

Bit	7	6	5	4	3	2	1	0
Name	Reserved	Reserved	Reserved	Reserved	Reserved	Reserved	Reserved	SIUCSEL
R/W	R	R	R	R	R	R	R	R/W
RTCRST	0	0	0	0	0	0	0	0
Other resets	0	0	0	0	0	0	0	0

Bit	Name	Function
7 to 1	Reserved	0 is returned when read
0	SIUCSEL	This bit is used to specify masking for echo-back of IrDA. 1: Mask disabled (normal mode) 0: Mask enabled (echo-back mode)

This register is used to specify whether masking is done for echo-back of IrDA transmission and reception.

25.3.16 SIUACTMSK_2 (0x0C00 000C)

Bit	7	6	5	4	3	2	1	0
Name	Reserved	Reserved	RxDMSK	RTSMSK	DCDMSK	DTRMSK	Reserved	TxWRMSK
R/W	R	R	R/W	R/W	R/W	R/W	R	R/W
RTCRST	0	0	0	0	0	0	0	0
Other resets	0	0	0	0	0	0	0	0

Bit	Name	Function
7, 6	Reserved	0 is returned when read
5	RxDMSK	Receive data mask 1: Mask 0: Unmask
4	RTSMSK	Request to send mask 1: Mask 0: Unmask
3	DCDMSK	Data carrier detect mask 1: Mask 0: Unmask
2	DTRMSK	Data transmit ready mask 1: Mask 0: Unmask
1	Reserved	0 is returned when read
0	TxWRMSK	Transmit buffer write mask 1: Mask 0: Unmask

When 1 is set in this register, state transition of the corresponding signals or write to transmit buffer does not retrigger the Activity Timer of the SIU2.

25.3.17 SIUACTTMR_2 (0x0C00 000E)

Bit	7	6	5	4	3	2	1	0
Name	SIUTMO7	SIUTMO6	SIUTMO5	SIUTMO4	SIUTMO3	SIUTMO2	SIUTMO1	SIUTMO0
R/W	R/W	R/W	R/W	R/W	R/W	R/W	R/W	R/W
RTCRST	0	0	0	0	0	0	0	0
Other resets	0	0	0	0	0	0	0	0

Bit	Name	Function
7 to 0	SIUTMO(7:0)	SIU activity timeout period 11111111 : 255 x 30.5 μ s 11111110 : 254 x 30.5 μ s : 01111111 : 127 x 30.5 μ s : 00000001 : 30.5 μ s 00000000 : Activity Timer disabled

CHAPTER 26 LCD CONTROLLER

26.1 Overview

The VR4181 includes an LCD control module which conforms to Modular Bus Architecture (MBA) and operates under the United Memory Architecture (UMA) conventions. The Frame Buffer resides in the main DRAM memory. This module also supports an STN LCD panel.

26.1.1 LCD interface

The VR4181 LCD controller is a UMA based controller in which the frame buffer is a part of system DRAM memory. The LCD controller supports monochrome STN LCD panels having 1-bit, 2-bit, and 4-bit data bus interfaces, and color STN LCD panels having 8-bit data bus interfaces. When interfacing to a color LCD panel, GPIO pins must be allocated to provide the upper nibble of the 8-bit LCD data bus.

In monochrome mode, the LCD controller supports 1-bpp mode (mono), 2-bpp mode (4 gray levels) and 4-bpp mode (16 gray levels). In color mode, the LCD controller supports 4-bpp mode (16 colors) and 8-bpp mode (256 colors). The LCD controller includes a 256-entry x 18-bit color pallet. In color 8-bpp mode, the pallet is used to select one of 256 colors out of a possible 261244.

The LCD controller can support up to 320 x 320 resolution, and typical LCD panel horizontal/vertical resolutions are as follow.

Table 26-1. LCD Panel Resolutions (in Pixels, TYP.)

Horizontal resolution	Vertical resolution
320	320
320	240
320	160
240	320
240	240
240	160
160	320
160	240
160	160

The LCD controller also provides power-on and power-down sequence control for the LCD panel via the VPLCD pin, which is for LCD logic power control, and VPBIAS pin, which is for LCD bias power control. Power sequencing is provided to prevent latch-up damage to the panel.

The LCD controller may be disabled to allow connection of an external LCDC with integrated frame buffer RAM such as NEC's μ PD16661. When the internal LCD controller is disabled by setting the LCDGPMODE register in the GIU, the SHCLK, LOCLK, VPLCD, and VPBIAS pins are redefined as follows:

Table 26-2. Redefining LCD Interface Pins When LCD Controller Is Disabled

Redefine function	Pin designation
LCDCS#	SHCLK
MEMCS16#	LOCLK
VPGPIO1	VPLCD
VPGPIO0	VPBIAS

26.2 Summary of LCD Module Features

- LCD resolutions
 - Horizontal: Up to 320 pixels (The number of pixels must be multiplies of 8)
 - Vertical: Up to 320 pixels
 - Color: 4 bpp, 8 bpp (MAX. 256 colors)
 - Monochrome: 1 bpp, 2 bpp, 4 bpp (MAX. 16 gray scale)
 - Color Palette: 18 bits
- High vertical refresh rates for flicker-free LCD frame modulation

The following is a block diagram of the LCD controller.

Figure 26-1. LCD Controller Block Diagram

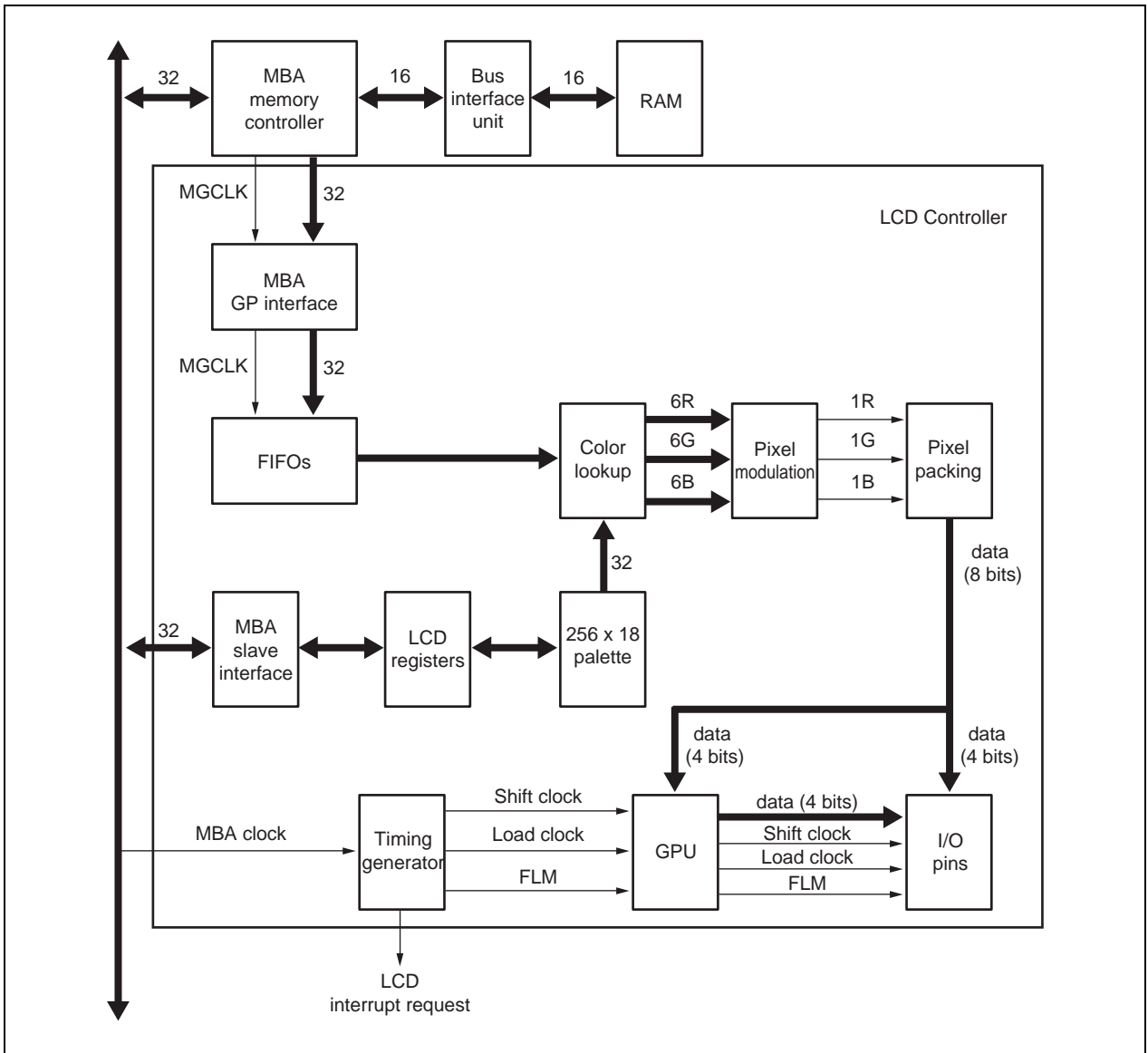

The LCD controller is a slave module of the MBA bus. Its registers can be accessed via the MBA slave interface. The frame data are read from main memory via the Memory Controller and the MBAGP (MBA Graphic port).

26.3 LCD Controller Specification

26.3.1 Panel configuration and interface

(1) View rectangle and horizontal/vertical blank

Most parameters of the LCD controller are described using a coordinate system. The x coordinate increases as a point moves to the right. The y coordinate increases as a point moves down. The origin is (0, 0).

The size of the bounding box is specified by Vtotal and Htotal. The point (Vtotal-1, Htotal-1) is the box's lower right corner and includes horizontal and vertical blank. Vvisible and Hvisible define the view rectangle, and outside of the view rectangle are horizontal blank and vertical blank.

Figure 26-2. View Rectangle and Horizontal/Vertical Blank

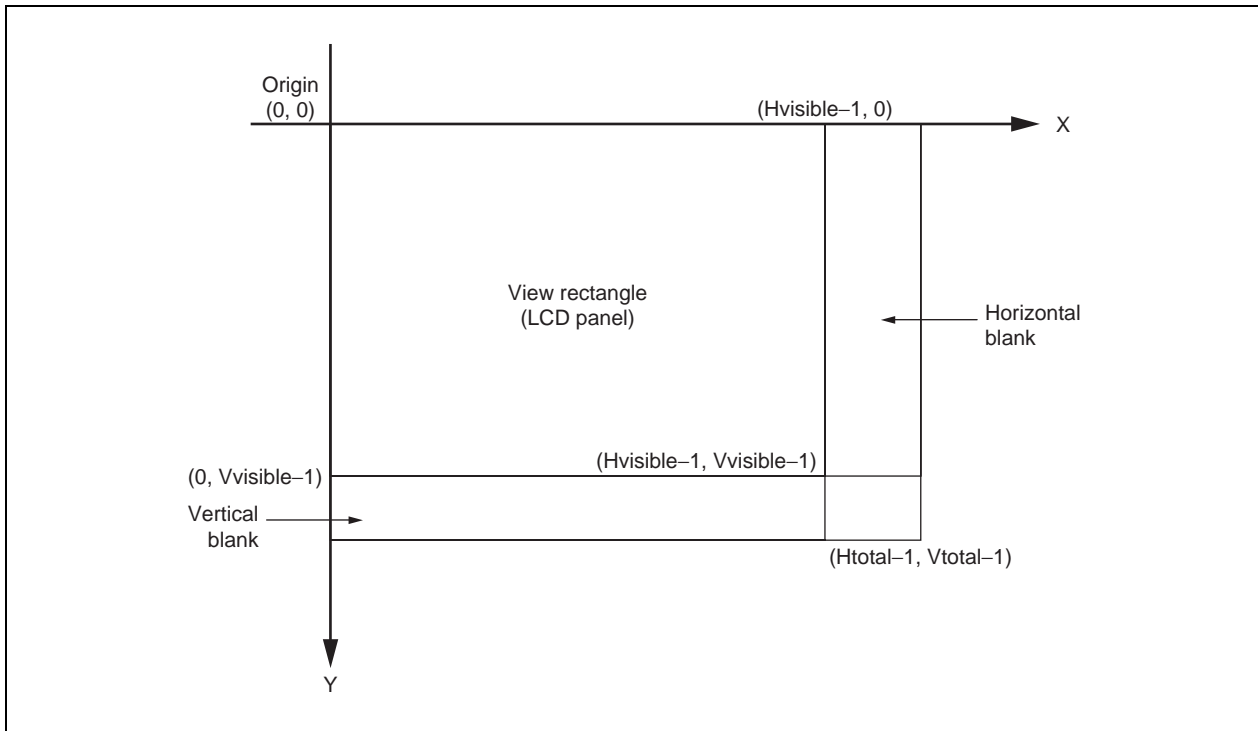

Each parameter is defined using bit values in the LCD controller registers as follows:

- Vtotal = Vtot(8:0) VRTOTALREG (0x0A00 0408)
- Vvisible = Vact(8:0) VRVISIBREG (0x0A00 040A)
- Htotal = Htot(7:0) x 2 HRTOTALREG (0x0A00 0400)
- Hvisible = Hact(5:0) x 8 HRVISIBREG (0x0A00 0402)

Caution Following expression must be satisfied.

1. Vtotal ≥ Vvisible
2. Htotal ≥ Hvisible + 6

(2) Load clock

The edge positions of load clock, LOCLK, are programmable. Each row in the rectangle (0, 0) and (Htotal-1, Vvisible-1) must have two LOCLK edges. The remaining rows in the frame rectangle form the vertical blank rectangle. These rows also have two LOCLK edges if DummyL bit of the VRVISIBREG register is 1, or none if DummyL bit is 0. The first LOCLK edge is defined by LCS(7:0) bits of the LDCLKSTREG register. The second edge is defined by LCE(7:0) bits of the LDCLKENDREG register, and is usually outside the view rectangle. LPPOL bit of the LCDCTRLREG register controls the directions of toggles. If LPPOL bit is 0, the first LOCLK edge is positive and the second is negative. If LPPOL bit is 1, the reverse is true.

Figure 26-3. Position of Load Clock, LOCLK

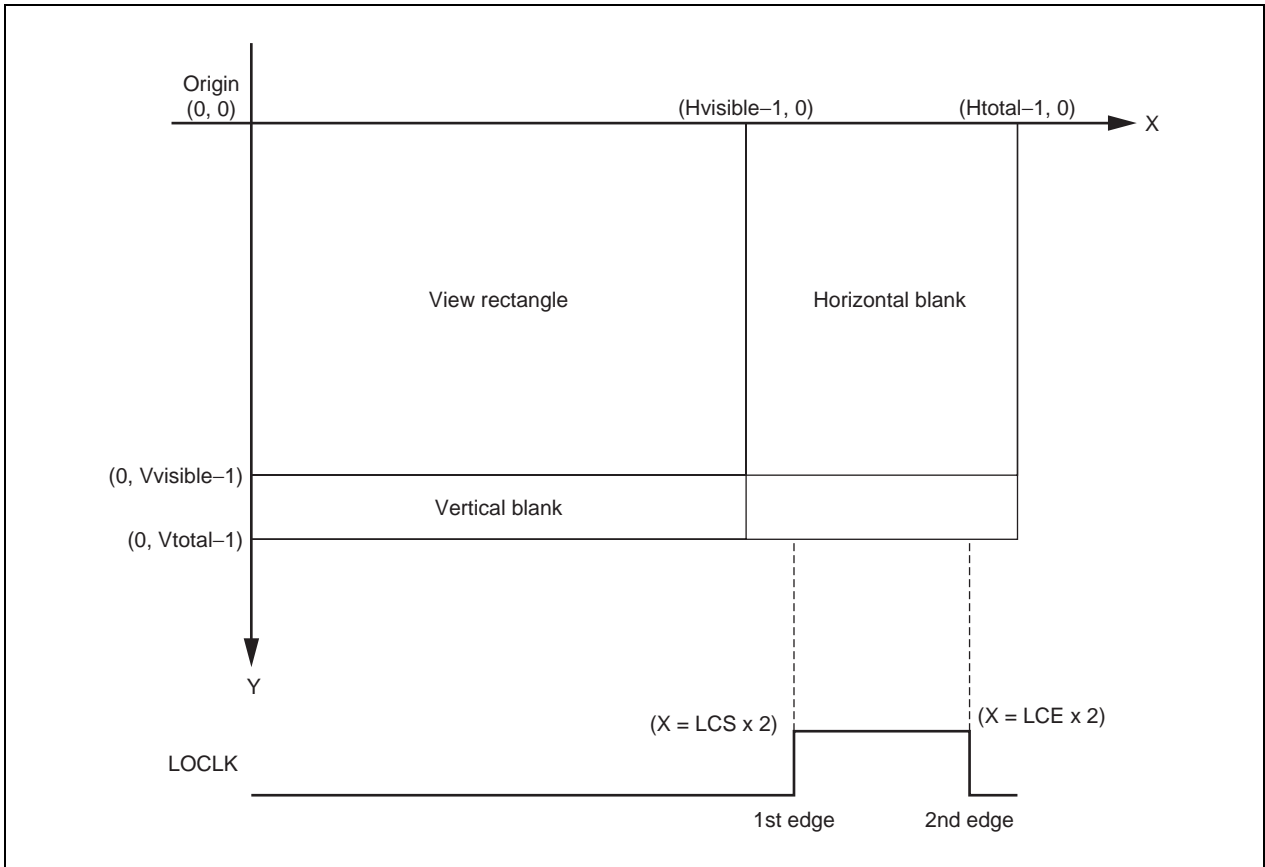

Caution Following expression must be satisfied.

1. $Htotal > LCE(7:0) \times 2 > LCS(7:0) \times 2$

(3) Frame clock

The edge positions of Frame clock, FLM, are also programmable. There must be exactly two FLM edges inside the bounding box. The first FLM edge is defined by FLMHS(7:0) bits of the FHSTARTREG register and FLMS(8:0) bits of the FVSTARTREG register. The location of the first edge is at (FLMHS x 2, FLMS). The second FLM edge is defined by FLMHE(7:0) bits of the FHENDREG register and FLME(8:0) bits of the FVENDREG register. The location of second edge is at (FLMHE x 2, FLME).

If FLMPOL bit of the LCDCTRLREG register is 0, the first FLM edge is positive and the second is negative. If FLMPOL bit is 1, the directions are reversed.

Figure 26-4. Position of Frame Edge, FLM

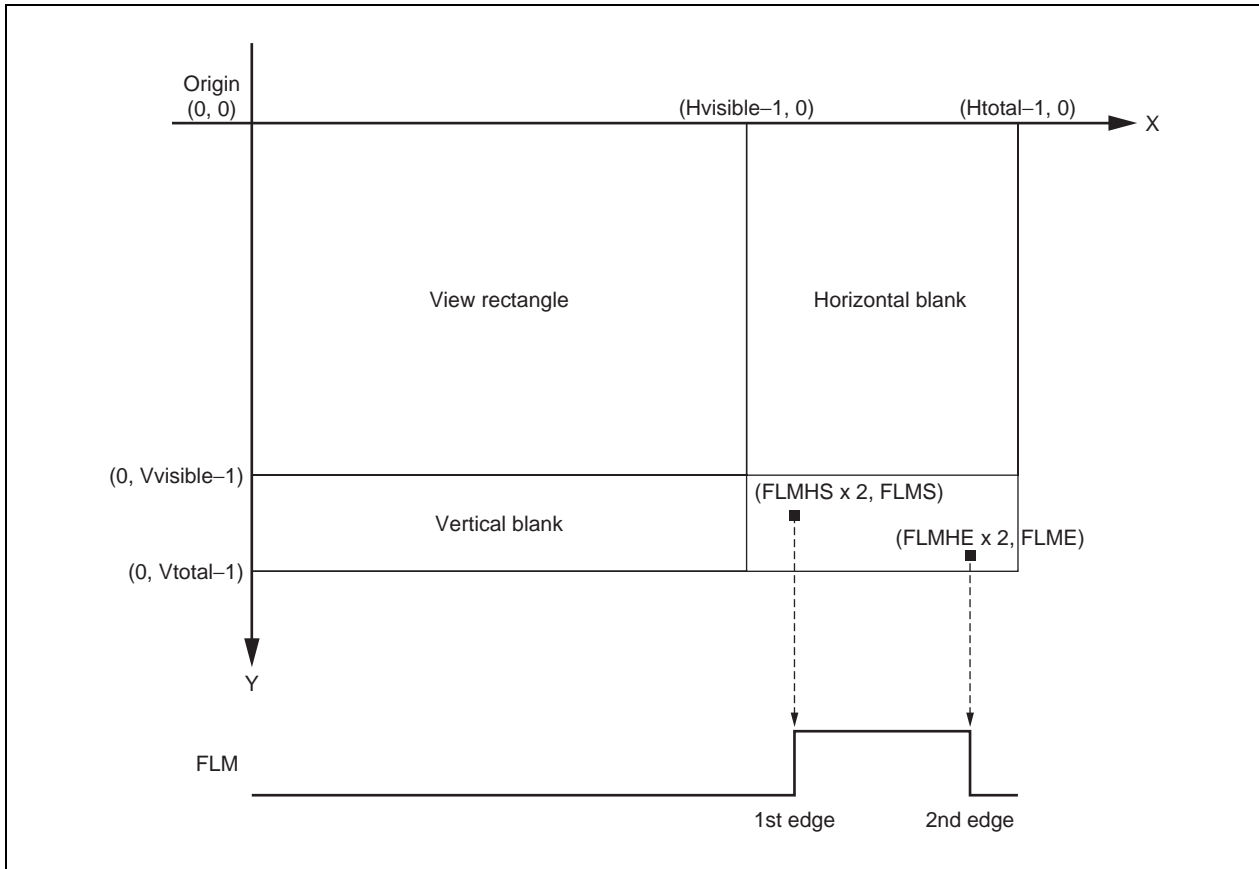

Caution Following expression must be satisfied.

1. $H_{total} > FLMHE(7:0) \times 2 > FLMHS(7:0) \times 2$
2. $V_{total} > FLME(8:0), V_{total} > FLMS(8:0)$

(4) Shift clock

Shift clock (SHCLK) edges can be programmed only indirectly. Shift clocks occur in rows of the vertical blank rectangle only if DummyL bit of the VRVISIBREG register is 1. The position of SHCLK edges are controlled by Panelcolor and PanDBus bits of the LCDCFGREG0 register. The SCLKPOL bit of the LCDCTRLREG register determines whether data is latched into the panel on the rising or falling edges. If SCLKPOL bit is 0, data is latched on the falling edges.

(5) M signal

Some panels also need a modulation signal, M, to operate properly. The modulation rate is controlled by MOD(7:0) bits of the LCDCFGREG0 register. If Mod field is 0, M toggles once per frame. If Mod field is not 0, then M toggles once every rows whose number is set in Mod field. M toggles at LCE position, the same time as the second LOCLK edge. When Mod field is 0, M toggles when LOCLK latches FLM.

(6) Vertical retrace interrupt

When the controller goes through the vertical blank rectangle, a status signal bit VIREq of the LCDINRQREG register becomes 1. This signal can be polled, or configured to generate an interrupt. To enable the interrupt, set MVIREq bit of LCDIMSKREG register to 1. Once the interrupt is generated, writing to VIREq bit clears the interrupt. However, the state of VIREq bit changes to 0 only after the controller returns to top left corner. Note that there is some delay between the controller's entering or leaving the vertical blank rectangle and the changes in VIREq bit.

26.3.2 Controller clocks

All LCD controller timing is based on the internal clock hpck. The hpck is derived from gclk, which is derived from the MBA clock (TClock). The frequency of gclk can be equal to, one-half of, or one-quarter of that of the MBA clock, depending on Pre-scal(1:0) bits of the LCDCFGREG0 register and the MBA clock frequency. The hpck frequency is programmable. In each cycle hpck is high for cycles set in HpckH(5:0) bits of the LCDCFGREG1 register, and low for cycles set in HpckL(5:0) bits of the LCDCFGREG1 register. The values in HpckH and HpckL fields are not arbitrary. Their sum must be at least 5, and the following condition must be satisfied:

$$fh_{pck} \approx H_{total} \times V_{total} \times f_{refresh}$$

Both hpck and gclk can be turned off when the panel is inactive. Setting ContCkE bit of the LCDCTRLREG register to 1 initializes the controller and turns on both clocks, or 0 turns them off.

26.3.3 Palette

Col(1:0) bits of the LCDCFGREG0 register indicate the desired color depth. If they are set to 0, then a monochrome image can be displayed on a monochrome panel. If they are set 1, then a 4-shade gray scale image can be displayed on a monochrome panel. If they are set to 2 or 3, then a palette is enabled, and a color or a monochrome panel can be used.

The palette has 256 entries. Each entry has 18 bits and is 6-6-6 format for the RGB color. To access an entry first store its index in PalIndex(7:0) bits of the CPINDCTREG register, then read from or write to PalData(17:0) bits of the CPALDATREG register. To accelerate continuous access, PalRDI bit of the CPINDCTREG register or PalWDI bit of the CPINDCTREG register can be set to 1. Setting PalRDI bit to 1 automatically adds 1 to PalIndex(7:0) bits of the CPINDCTREG register after reading from PalData field, and setting PalWDI bit to 1 automatically adds 1 to PalIndex bit after writing to PalData field.

If Col field is set to 2, then the pixel data provides only the lower half of the palette index. The upper half is provided by PalPage(3:0) bits of the CPINDCTREG register. Together they specify one entry in the palette.

Finally, hpck and gck must be turned on before the palette can be accessed.

26.3.4 Frame buffer memory and FIFO

The frame buffer is linear and supports a packed pixel format. The length of a scan line must be a multiple of 32 bits. The last double word of a scan line need not be completely filled. The pixels are stored in double words. The data format of each double word depends on the color depth, as shown in the following table.

Bit 31																														Bit 0		
	18	19	1A	1B	1C	1D	1E	1F	10	11	12	13	14	15	16	17	08	09	0A	0B	0C	0D	0E	0F	00	01	02	03	04	05	06	07
	0C		0D		0E		0F		08		09		0A		0B		04		05		06		07		00		01		02		03	
	06				07				04				05				02				03				00				01			
	03								02								01								00							

The frame buffer memory starts from the 32-bit address specified by FBSA(31:0) bits of the FBSTADREG1 and FBSTADREG2 registers. And also, the frame buffer memory end address is specified by FBEA(31:0) bits of the FBADNREG1 and FBADNREG2 registers. FBEA field does not show where the last pixel is stored; but it is the address of the first 32-byte page boundary, starting from the address set in FBSA field, immediately following the memory location where the last pixel is stored. For example, if FBSA field is 0x0B00 0408, and the frame buffer occupies 235 bytes, then FBEA field is 0x0B00 0508 (FBSA plus the ceiling of 235/32).

Data from the frame buffer is burst into the FIFO to conserve memory bandwidth. Each burst transfers 32 bytes. The FIFO is divided into three arrays, and each burst fills exactly one array. Bursts can not cross array borders, nor can the FIFO read from and write to the same array at the same time. When the memory bandwidth is low, the FIFO bursts only when there are only the number of double words left to read which is displayed in FIFOC(2:0) bits of the LCDCTRLREG register. If the burst is not fast enough to fill up the next array, then irreversible image degradation occurs, and an interrupt request is generated. This interrupt request can be polled from FIFOVERR bit of the LCDINRQREG register. It can be cleared only by stopping and then restarting controller clocks. Because image degradation is a serious problem, the value set to FIFOC field should be carefully selected during development.

26.3.5 Panel power ON/OFF sequence

Some panels use several power supplies, and these supplies and interface logic signals must be turned on or off in sequences specified by the manufacturers. The LCD controller has signals to control these power supplies.

Each power supply is controlled by VPBIAS or VPLCD pin. This pin is connected to a pull-up or pull-down resistor in addition to the power supply. When the power is off, the pin is placed into high impedance mode, thus the resistor pulls the supply on/off input to the off state.

The power-on/off sequence is started by setting PowerC bit of the PWRCONREG2 register. Setting this bit to 1 starts the power on sequence. In the power-on sequence the supply control pins are brought out of the high impedance mode to programmed states at programmed times, and the panel interface signals become active at a programmed time. The following table lists the control pins and the programming registers.

Pin	Power-on time bit	Power-on state bit
VPBIAS	BiasOn(4:0)	BiasC
VPLCD	VccOn(4:0)	VccC
LCD Interface	I/Fon(4:0)	– (0 until active)

For example, storing 1 in BiasC bit and 3 in BiasOn field tells the controller to bring VPBIAS signal from high impedance to high three frames after PowerC bit is set to 1, not counting the frame in which PowerC bit is changed.

Setting PowerC bit to 0 starts the power-off sequence. In the power-off sequence the control pins are put into the high impedance mode, thus turning off the power supplies. The pins enter high impedance mode in the reverse order of the power-on sequence, but the time difference between two control pins remains the same.

26.3.6 Controller operation diagrams

Figure 26-5. Monochrome Panel

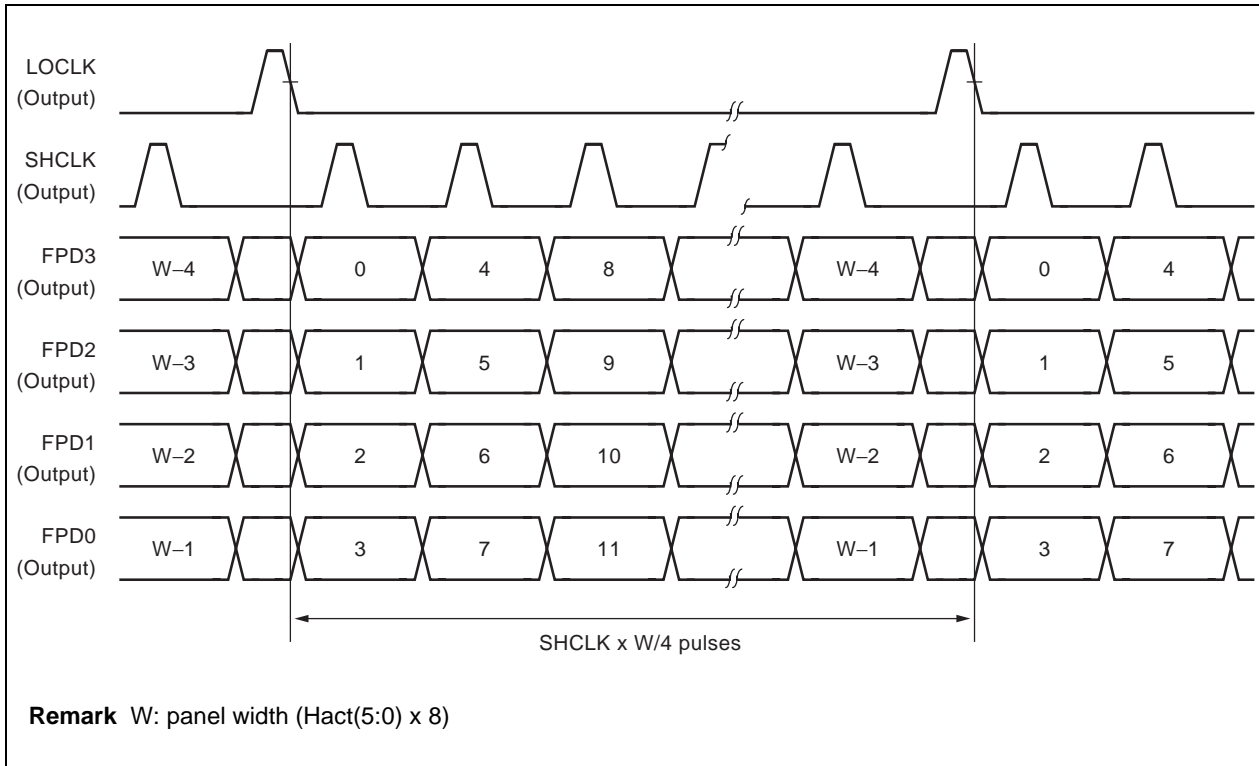

The polarity of LOCLK and SHCLK are programmable by SCLKPOL and LPPOL bits.

Figure 26-6. Color Panel in 8-bit Data Bus

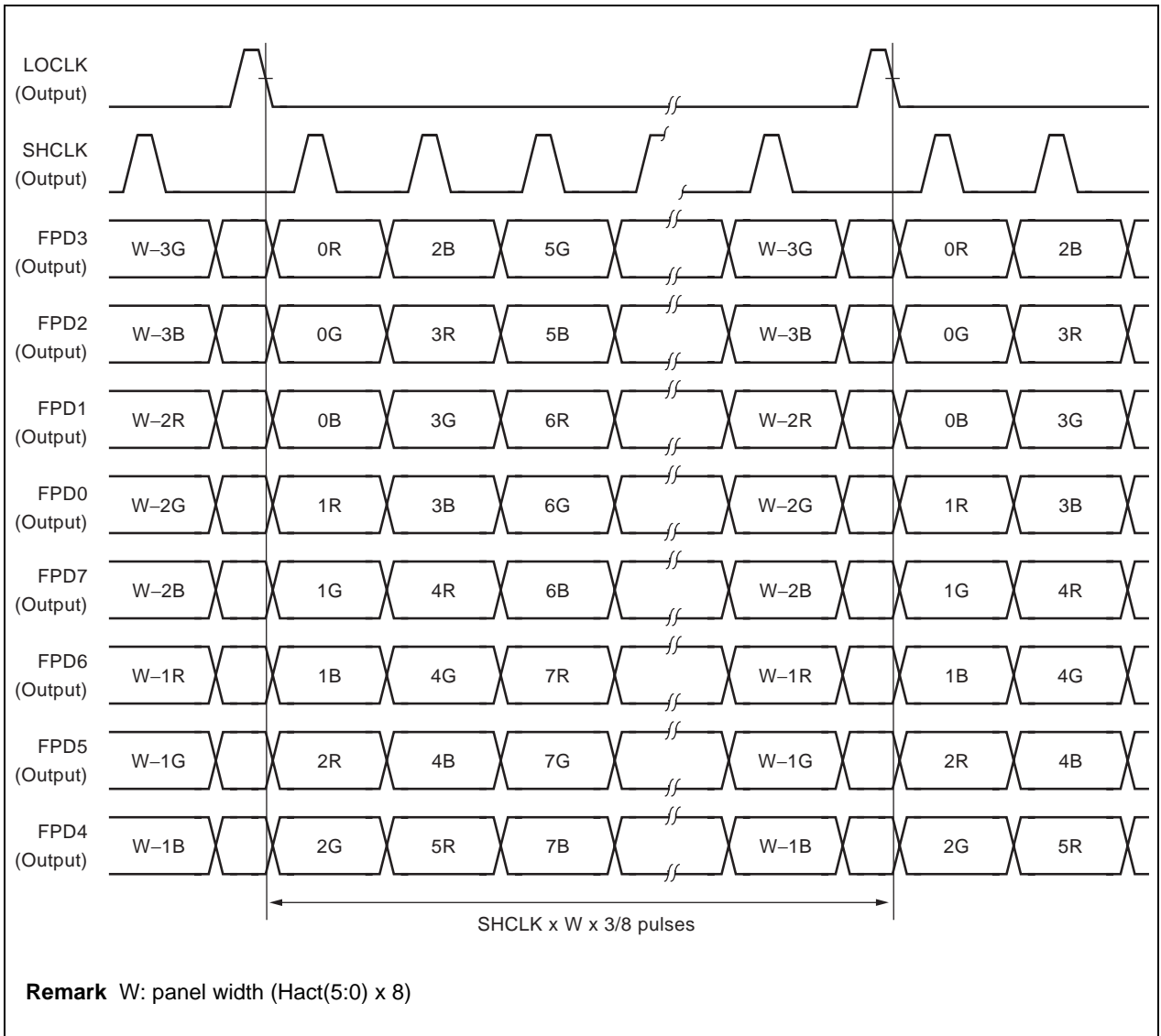

The polarity of LOCLK and SHCLK are programmable by LPPOL and SCLKPOL bits.

Remark In Color 8-bit data bus mode, FPD(3:0) are for upper 4 bits of LCD data bus, and FPD(7:4) are for lower 4 bit of LCD data bus.

Figure 26-7. Load Clock (LOCLK)

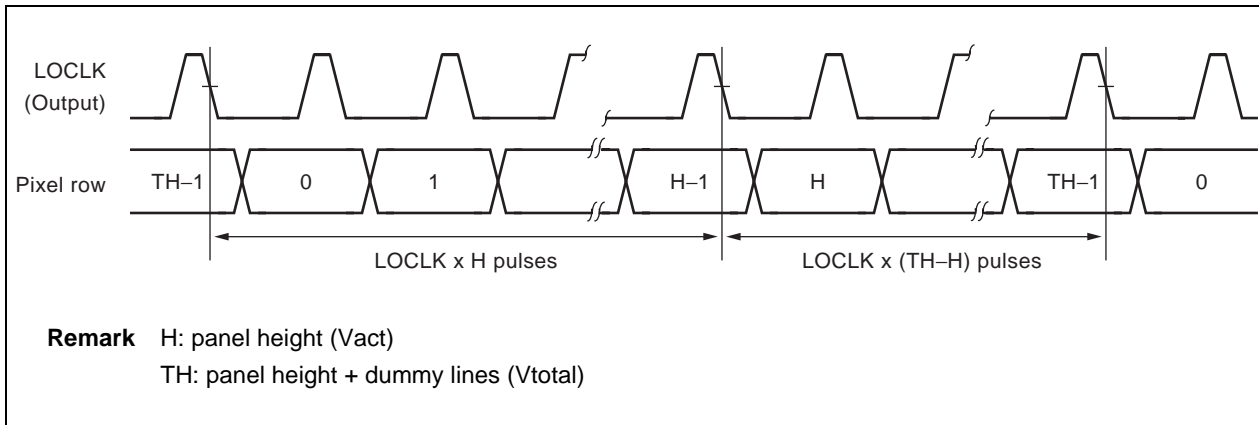

Remark Dummy lines are inserted when needed. For example, some panels can display only 240 lines, but has 242 line cycles. Load clock can be deactivated for the dummy lines (see DummyL bit description in 26.4.6).

Figure 26-8. Frame Clock (FLM)

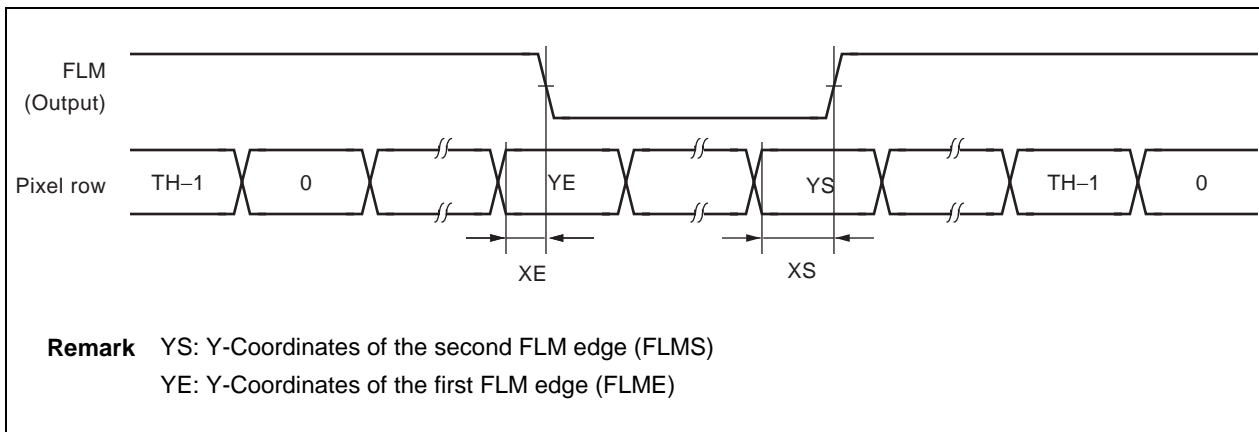

The polarity of FLM is programmable by FLMPOL bit.
XS and XE are discussed in timing diagrams.

Figure 26-9. LCD Timing Parameters

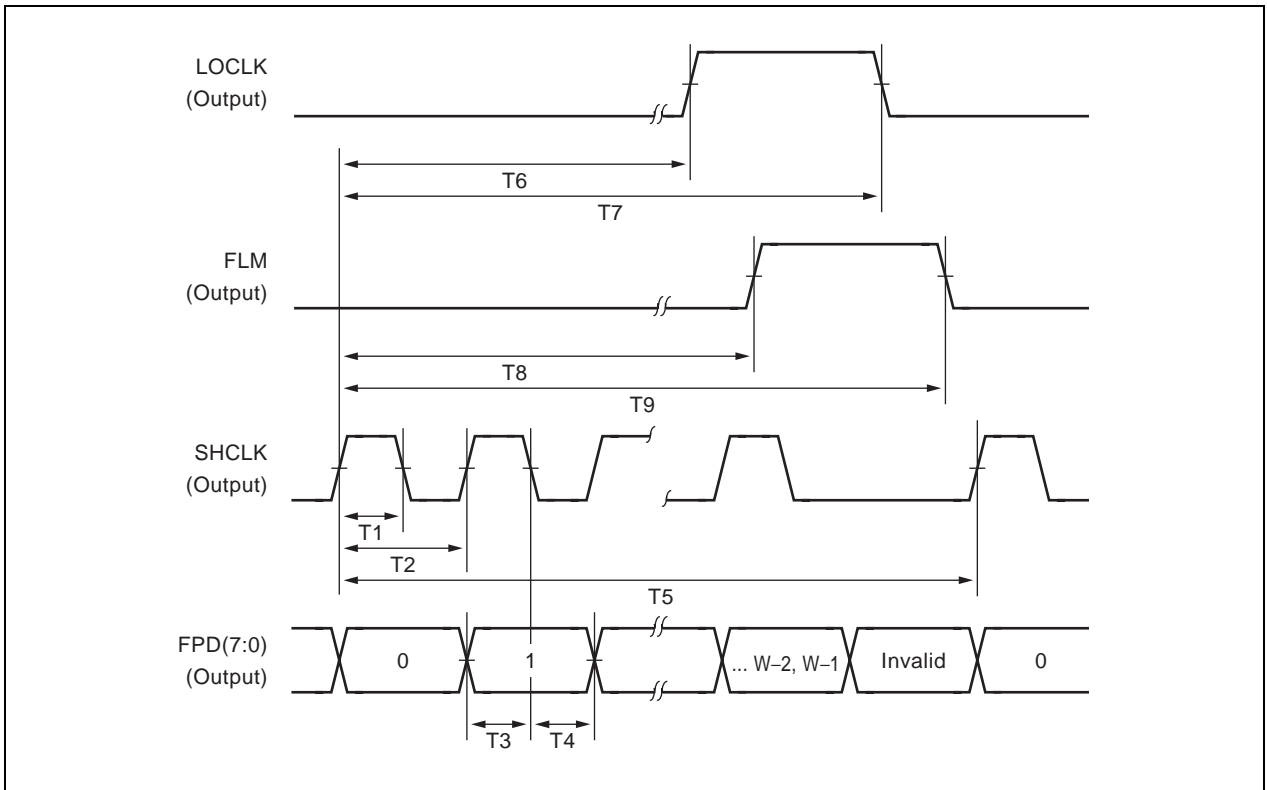

The polarity of FLM is programmable through FLMPOL bit. In this diagram the first edge is a rising edge.

The two FLM edges are on the same row in this diagram, but they need not be.

The active edge of LOCLK is programmable through LPPOL bit. The falling edge is the active edge in this diagram.

The polarity of SHCLK is programmable through SCLKPOL bit. The falling edge is the active edge in this diagram.

Figure 26-10. FLM Period

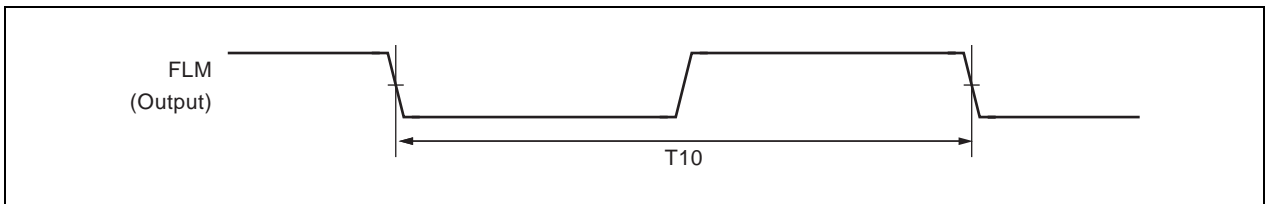

The definitions of parameters shown in the figures are given in the table below.

Table 26-3. LCD Controller Parameters

Symbol	Definition
Tg	gclk period This parameter is not one of the timing parameters, but all timing parameters can be calculated from Tg. gclk is controlled by Pre-scal field. $Tg = 1 / (\text{frequency of gclk})$
T1	Shift clock high level width Color: $T1 = Tg \times HpckH$ 4-bit bus Mono: $T1 = Tg \times (HpckH + HpckL)$
T2	Shift clock cycle Color: $T2 = Tg \times (HpckH + HpckL)$ 4-bit bus Mono: $T2 = Tg \times (HpckH + HpckL) \times 2$
T3	Panel data setup time Color : $T3 = Tg \times HpckH$ 4-bit bus Mono: $T3 = Tg \times (HpckH + HpckL)$
T4	Panel data hold time Color: $T4 = Tg \times HpckL$ 4-bit bus Mono: $T4 = Tg \times (HpckH + HpckL)$
T5	Row cycle time $T5 = Tg \times (HpckH + HpckL) \times Htot$
T6	Load clock start time $T6 = Tg \times (HpckH + HpckL) \times LCS$
T7	Load clock end time $T7 = Tg \times (HpckH + HpckL) \times LCE$
T8	FLM horizontal start time $T8 = Tg \times (HpckH + HpckL) \times FLMHS$
T9	FLM horizontal end time $T9 = Tg \times (HpckH + HpckL) \times FLMHE$
T10	Panel frame period $T10 = Tg \times (HpckH + HpckL) \times Htot \times Vtot$

26.4 Register Set

Table 26-4. LCD Controller Registers

Address	R/W	Register symbol	Function
0x0A00 0400	R/W	HRTOTALREG	Horizontal total register
0x0A00 0402	R/W	HRVISIBREG	Horizontal visible register
0x0A00 0404	R/W	LDCLKSTREG	Load clock start register
0x0A00 0406	R/W	LDCLKENDREG	Load clock end register
0x0A00 0408	R/W	VRTOTALREG	Vertical total register
0x0A00 040A	R/W	VRVISBREG	Vertical visible register
0x0A00 040C	R/W	FVSTARTREG	FLM vertical start register
0x0A00 040E	R/W	FVENDREG	FLM vertical end register
0x0A00 0410	R/W	LCDCCTRLREG	LCD control register
0x0A00 0412	R/W	LCDINTRQREG	LCD interrupt request register
0x0A00 0414	R/W	LCDCFGREG0	LCD configuration register 0
0x0A00 0416	R/W	LCDCFGREG1	LCD configuration register 1
0x0A00 0418	R/W	FBSTADREG1	Frame buffer start address 1 register
0x0A00 041A	R/W	FBSTADREG2	Frame buffer start address 2 register
0x0A00 0420	R/W	FBENDADREG1	Frame buffer end address 1 register
0x0A00 0422	R/W	FBENDADREG2	Frame buffer end address 2 register
0x0A00 0424	R/W	FHSTARTREG	FLM horizontal start register
0x0A00 0426	R/W	FHENDREG	FLM horizontal end register
0x0A00 0430	R/W	PWRCONREG1	Power control register 1
0x0A00 0432	R/W	PWRCONREG2	Power control register 2
0x0A00 0434	R/W	LCDIMSKREG	LCD interrupt mask register
0x0A00 047E	R/W	CPINDCTREG	Color palette index and control register
0x0A00 0480	R/W	CPALDATREG	Color palette data register (32 bits wide)

26.4.1 HRTOTALREG (0x0A00 0400)

Bit	15	14	13	12	11	10	9	8
Name	Reserved	Reserved	Reserved	Reserved	Reserved	Reserved	Reserved	Reserved
R/W	R	R	R	R	R	R	R	R
Reset	0	0	0	0	0	0	0	0

Bit	7	6	5	4	3	2	1	0
Name	Htot7	Htot6	Htot5	Htot4	Htot3	Htot2	Htot1	Htot0
R/W	R/W	R/W	R/W	R/W	R/W	R/W	R/W	R/W
Reset	0	0	0	0	0	0	0	0

Bit	Name	Function
15 to 8	Reserved	0 is returned when read
7 to 0	Htot(7:0)	Horizontal total amount columns. Set (Horizontal total) / 2 in this register. Horizontal total = Horizontal visible width + Horizontal blank

26.4.2 HRVISIBREG (0x0A00 0402)

Bit	15	14	13	12	11	10	9	8
Name	Reserved	Reserved	Reserved	Reserved	Reserved	Reserved	Reserved	Reserved
R/W	R	R	R	R	R	R	R	R
Reset	0	0	0	0	0	0	0	0

Bit	7	6	5	4	3	2	1	0
Name	Reserved	Reserved	Hact5	Hact4	Hact3	Hact2	Hact1	Hact0
R/W	R	R	R/W	R/W	R/W	R/W	R/W	R/W
Reset	0	0	0	0	0	0	0	0

Bit	Name	Function
15 to 6	Reserved	0 is returned when read
5 to 0	Hact(5:0)	Horizontal visible amount in pixel. Set (Horizontal visible columns) / 8 in this register.

26.4.3 LDCLKSTREG (0x0A00 0404)

Bit	15	14	13	12	11	10	9	8
Name	Reserved	Reserved	Reserved	Reserved	Reserved	Reserved	Reserved	Reserved
R/W	R	R	R	R	R	R	R	R
Reset	0	0	0	0	0	0	0	0

Bit	7	6	5	4	3	2	1	0
Name	LCS7	LCS6	LCS5	LCS4	LCS3	LCS2	LCS1	LCS0
R/W	R/W	R/W	R/W	R/W	R/W	R/W	R/W	R/W
Reset	0	0	0	0	0	0	0	0

Bit	Name	Function
15 to 8	Reserved	0 is returned when read
7 to 0	LCS(7:0)	X coordinate of the first edge of LOCLK. Set (First edge of LOCLK) / 2 in this register.

26.4.4 LDCLKNDREG (0x0A00 0406)

Bit	15	14	13	12	11	10	9	8
Name	Reserved	Reserved	Reserved	Reserved	Reserved	Reserved	Reserved	Reserved
R/W	R	R	R	R	R	R	R	R
Reset	0	0	0	0	0	0	0	0

Bit	7	6	5	4	3	2	1	0
Name	LCE7	LCE6	LCE5	LCE4	LCE3	LCE2	LCE1	LCE0
R/W	R/W	R/W	R/W	R/W	R/W	R/W	R/W	R/W
Reset	0	0	0	0	0	0	0	0

Bit	Name	Function
15 to 8	Reserved	0 is returned when read
7 to 0	LCE(7:0)	X coordinate of the second edge of LOCLK. Set (Second edge of LOCLK) / 2 in this register.

26.4.5 VRTOTALREG (0x0A00 0408)

Bit	15	14	13	12	11	10	9	8
Name	Reserved	Reserved	Reserved	Reserved	Reserved	Reserved	Reserved	Vtot8
R/W	R	R	R	R	R	R	R	R/W
Reset	0	0	0	0	0	0	0	0

Bit	7	6	5	4	3	2	1	0
Name	Vtot7	Vtot6	Vtot5	Vtot4	Vtot3	Vtot2	Vtot1	Vtot0
R/W	R/W	R/W	R/W	R/W	R/W	R/W	R/W	R/W
Reset	0	0	0	0	0	0	0	0

Bit	Name	Function
15 to 9	Reserved	0 is returned when read
8 to 0	Vtot(8:0)	Vertical total amount of lines including vertical retrace period

26.4.6 VRVISIBREG (0x0A00 040A)

Bit	15	14	13	12	11	10	9	8
Name	DummyL	Reserved	Reserved	Reserved	Reserved	Reserved	Reserved	Vact8
R/W	R/W	R	R	R	R	R	R	R/W
Reset	0	0	0	0	0	0	0	0

Bit	7	6	5	4	3	2	1	0
Name	Vact7	Vact6	Vact5	Vact4	Vact3	Vact2	Vact1	Vact0
R/W	R/W	R/W	R/W	R/W	R/W	R/W	R/W	R/W
Reset	0	0	0	0	0	0	0	0

Bit	Name	Function
15	DummyL	Dummy line insertion 0 : Immediately before vertical blank 1 : In vertical blank
14 to 9	Reserved	0 is returned when read
8 to 0	Vact(8:0)	Vertical visible amounts of lines

26.4.7 FVSTARTREG (0x0A00 040C)

Bit	15	14	13	12	11	10	9	8
Name	Reserved	Reserved	Reserved	Reserved	Reserved	Reserved	Reserved	FLMS8
R/W	R	R	R	R	R	R	R	R/W
Reset	0	0	0	0	0	0	0	0

Bit	7	6	5	4	3	2	1	0
Name	FLMS7	FLMS6	FLMS5	FLMS4	FLMS3	FLMS2	FLMS1	FLMS0
R/W	R/W	R/W	R/W	R/W	R/W	R/W	R/W	R/W
Reset	0	0	0	0	0	0	0	0

Bit	Name	Function
15 to 9	Reserved	0 is returned when read
8 to 0	FLMS(8:0)	Y coordinate of the first FLM edge

26.4.8 FVENDREG (0x0A00 040E)

Bit	15	14	13	12	11	10	9	8
Name	Reserved	Reserved	Reserved	Reserved	Reserved	Reserved	Reserved	FLME8
R/W	R	R	R	R	R	R	R	R/W
Reset	0	0	0	0	0	0	0	0

Bit	7	6	5	4	3	2	1	0
Name	FLME7	FLME6	FLME5	FLME4	FLME3	FLME2	FLME1	FLME0
R/W	R/W	R/W	R/W	R/W	R/W	R/W	R/W	R/W
Reset	0	0	0	0	0	0	0	0

Bit	Name	Function
15 to 9	Reserved	0 is returned when read
8 to 0	FLME(8:0)	Y Coordinate of the second FLM edge

26.4.9 LCDCTRLREG (0x0A00 0410)

Bit	15	14	13	12	11	10	9	8
Name	Reserved	Reserved	Reserved	Reserved	Reserved	Reserved	Reserved	Reserved
R/W	R	R	R	R	R	R	R	R
Reset	0	0	0	0	0	0	0	0

Bit	7	6	5	4	3	2	1	0
Name	FIFOC2	FIFOC1	FIFOC0	Reserved	ContCkE	LPPOL	FLMPOL	SCLKPOL
R/W	R/W	R/W	R/W	R	R/W	R/W	R/W	R/W
Reset	0	0	0	0	0	0	0	0

Bit	Name	Function
15 to 8	Reserved	0 is returned when read
7 to 5	FIFOC(2:0)	FIFO control. A FIFO fill is performed when only the number of double words set here is left on the FIFO.
4	Reserved	0 is returned when read
3	ContCkE	LCD controller clock enable 0 : OFF 1 : ON
2	LPPOL	LOCLK clock polarity 0 : Leading edge is rising 1 : Leading edge is falling
1	FLMPOL	FLM clock polarity 0 : Leading edge is rising 1 : Leading edge is falling
0	SCLKPOL	Shift clock polarity 0 : Negative polarity 1 : Positive polarity

26.4.10 LCDINRQREG (0x0A00 0412)

Bit	15	14	13	12	11	10	9	8
Name	Reserved	Reserved	Reserved	Reserved	Reserved	Reserved	Reserved	Reserved
R/W	R	R	R	R	R	R	R	R
Reset	0	0	0	0	0	0	0	0

Bit	7	6	5	4	3	2	1	0
Name	Reserved	Reserved	Reserved	Reserved	Reserved	VIReq	FIFOV ERR	Reserved
R/W	R	R	R	R	R	R/W	R/W	R
Reset	0	0	0	0	0	0	0	0

Bit	Name	Function
15 to 3	Reserved	0 is returned when read
2	VIReq	Vertical retrace interrupt request 0 : No request (outside vertical blank) 1 : Request (vertical blank)
1	FIFOVERR	FIFO Overrun interrupt request 0 : No request 1 : Request
0	Reserved	0 is returned when read

26.4.11 LCDCFGREG0 (0x0A00 0414)

Bit	15	14	13	12	11	10	9	8
Name	MOD7	MOD6	MOD5	MOD4	MOD3	MOD2	MOD1	MOD0
R/W	R/W	R/W	R/W	R/W	R/W	R/W	R/W	R/W
Reset	0	0	0	0	0	0	0	0

Bit	7	6	5	4	3	2	1	0
Name	Softreset	Reserved	Pre-scal1	Pre-scal0	Col1	Col0	Panelcolor	PanDbus
R/W	R/W	R	R/W	R/W	R/W	R/W	R/W	R/W
Reset	0	0	0	0	0	0	0	0

Bit	Name	Function
15 to 8	MOD(7:0)	LCD M signal configuration. These bits specify the number of lines between M toggles as follows: 0 : Once per frame 1 : After every line 2 : After every 2 lines : 255 : After every 255 lines
7	Softreset	Software reset for LCD controller. The software reset is active only in test mode 0 : Normal 1 : Reset
6	Reserved	0 is returned when read
5, 4	Pre-scal(1:0)	gclk (clock for LCD controller) pre-scalar mode to the MBA clock 00 : Divide by 1 01 : Divide by 2 10 : Divide by 4 11 : RFU
3, 2	Col(1:0)	Color depth select 00 : 1 bit (black and white for monochrome panel) 01 : 2 bits (4 gray scale for monochrome panel) 10 : 4 bits (16 gray scale or 16 colors for monochrome or color panel) 11 : 8 bits (256 colors for color panel)
1	Panelcolor	Color/monochrome select 0 : Color 1 : Monochrome
0	PanDbus	Panel data width 0 : 4 bits 1 : 8 bits (for dual scan panel or for 8-bit high scan)

26.4.12 LCDCFGREG1 (0x0A00 0416)

Bit	15	14	13	12	11	10	9	8
Name	Reserved	Reserved	HpckL5	HpckL4	HpckL3	HpckL2	HpckL1	HpckL0
R/W	R	R	R/W	R/W	R/W	R/W	R/W	R/W
Reset	0	0	0	0	0	0	0	0

Bit	7	6	5	4	3	2	1	0
Name	Reserved	Reserved	HpckH5	HpckH4	HpckH3	HpckH2	HpckH1	HpckH0
R/W	R	R	R/W	R/W	R/W	R/W	R/W	R/W
Reset	0	0	0	0	0	0	0	0

Bit	Name	Function
15, 14	Reserved	0 is returned when read
13 to 8	HpckL(5:0)	Number of gclk cycles for Hpck low time
7, 6	Reserved	0 is returned when read
5 to 0	HpckH(5:0)	Number of gclk cycles for Hpck high time

26.4.13 FBSTAD1REG (0x0A00 0418)

Bit	15	14	13	12	11	10	9	8
Name	FBSA15	FBSA14	FBSA13	FBSA12	FBSA11	FBSA10	FBSA9	FBSA8
R/W	R/w	R/W	R/W	R/W	R/W	R/W	R/W	R/W
Reset	0	0	0	0	0	0	0	0

Bit	7	6	5	4	3	2	1	0
Name	FBSA7	FBSA6	FBSA5	FBSA4	FBSA3	FBSA2	FBSA1	FBSA0
R/W	R/W	R/W	R/W	R/W	R/W	R/W	R/W	R/W
Reset	0	0	0	0	0	0	0	0

Bit	Name	Function
15 to 0	FBSA(15:0)	Frame buffer start address (lower 16 bits)

Caution FBSA(2:0) bits must be cleared to 0.

26.4.14 FBSTAD2REG (0x0A00 041A)

Bit	15	14	13	12	11	10	9	8
Name	FBSA31	FBSA30	FBSA29	FBSA28	FBSA27	FBSA26	FBSA25	FBSA24
R/W	R	R	R	R/W	R/W	R/W	R/W	R/W
Reset	0	0	0	0	0	0	0	0

Bit	7	6	5	4	3	2	1	0
Name	FBSA23	FBSA22	FBSA21	FBSA20	FBSA19	FBSA18	FBSA17	FBSA16
R/W	R/W	R/W	R/W	R/W	R/W	R/W	R/W	R/W
Reset	0	0	0	0	0	0	0	0

Bit	Name	Function
15 to 0	FBSA(31:16)	Frame buffer start address (upper 16 bits) FBSA(31:29) are always 0 when read.

The FBSTAD1REG and FBSTAD2REG registers specify the frame buffer starting address. The frame buffer is linear and the pixels are packed. This address corresponds to the first, top left pixel of the screen.

26.4.15 FBENDADREG1 (0x0A00 0420)

Bit	15	14	13	12	11	10	9	8
Name	FBEA15	FBEA14	FBEA13	FBEA12	FBEA11	FBEA10	FBEA9	FBEA8
R/W	R/W	R/W	R/W	R/W	R/W	R/W	R/W	R/W
Reset	0	0	0	0	0	0	0	0

Bit	7	6	5	4	3	2	1	0
Name	FBEA7	FBEA6	FBEA5	FBEA4	FBEA3	FBEA2	FBEA1	FBEA0
R/W	R/W	R/W	R/W	R/W	R/W	R/W	R/W	R/W
Reset	0	0	0	0	0	0	0	0

Bit	Name	Function
15 to 0	FBEA(15:0)	Frame buffer end address (lower 16 bits)

26.4.16 FBENDADREG2 (0x0A00 0422)

Bit	15	14	13	12	11	10	9	8
Name	FBEA31	FBEA30	FBEA29	FBEA28	FBEA27	FBEA26	FBEA25	FBEA24
R/W	R	R	R	R/W	R/W	R/W	R/W	R/W
Reset	0	0	0	0	0	0	0	0

bit	7	6	5	4	3	2	1	0
Name	FBEA23	FBEA22	FBEA21	FBEA20	FBEA19	FBEA18	FBEA17	FBEA16
R/W	R/W	R/W	R/W	R/W	R/W	R/W	R/W	R/W
Reset	0	0	0	0	0	0	0	0

Bit	Name	Function
15 to 0	FBEA(31:16)	Frame buffer end address (upper 16 bits) FBEA(31:29) are always 0 when read.

26.4.17 FHSTARTREG (0x0A00 0424)

Bit	15	14	13	12	11	10	9	8
Name	Reserved	Reserved	Reserved	Reserved	Reserved	Reserved	Reserved	Reserved
R/W	R	R	R	R	R	R	R	R
Reset	0	0	0	0	0	0	0	0

Bit	7	6	5	4	3	2	1	0
Name	FLMHS7	FLMHS6	FLMHS5	FLMHS4	FLMHS3	FLMHS2	FLMHS1	FLMHS0
R/W	R/W	R/W	R/W	R/W	R/W	R/W	R/W	R/W
Reset	0	0	0	0	0	0	0	0

Bit	Name	Function
15 to 8	Reserved	0 is returned when read
7 to 0	FLMHS(7:0)	X coordinate of the first FLM edge Set (the first edge of FLM) / 2 in this register.

26.4.18 FHNSDREG (0x0A00 0426)

Bit	15	14	13	12	11	10	9	8
Name	Reserved	Reserved	Reserved	Reserved	Reserved	Reserved	Reserved	Reserved
R/W	R	R	R	R	R	R	R	R
Reset	0	0	0	0	0	0	0	0

Bit	7	6	5	4	3	2	1	0
Name	FLMHE7	FLMHE6	FLMHE5	FLMHE4	FLMHE3	FLMHE2	FLMHE1	FLMHE0
R/W	R/W	R/W	R/W	R/W	R/W	R/W	R/W	R/W
Reset	0	0	0	0	0	0	0	0

Bit	Name	Function
15 to 8	Reserved	0 is returned when read
7 to 0	FLMHE(7:0)	X coordinate of the second FLM edge Set (the second edge of FLM) / 2 in this register.

26.4.19 PWRCONREG1 (0x0A00 0430)

Bit	15	14	13	12	11	10	9	8
Name	Reserved	Reserved	Reserved	Reserved	Reserved	Reserved	Reserved	Reserved
R/W	R	R/W	R/W	R/W	R/W	R/W	R/W	R/W
Reset	0	0	0	0	0	0	00	0

Bit	7	6	5	4	3	2	1	0
Name	Reserved	Reserved	Reserved	Biason4	Biason3	Biason2	Biason1	Biason0
R/W	R/W	R/W	R/W	R/W	R/W	R/W	R/W	R/W
Reset	0	0	0	0	0	0	0	0

Bit	Name	Function
15	Reserved	0 is returned when read
14 to 5	Reserved	Write 0 when write. 0 is returned when read
4 to 0	Biason(4:0)	Bias voltage is turned on at this frame

26.4.20 PWRCONREG2 (0x0A00 0432)

Bit	15	14	13	12	11	10	9	8
Name	Testmode	VccC	Reserved	Reserved	BiasCon	PowerC	I/Fon4	I/Fon3
R/W	R/W	R/W	R/W	R/W	R/W	R/W	R/W	R/W
Reset	0	0	0	0	0	0	0	0

Bit	7	6	5	4	3	2	1	0
Name	I/Fon2	I/Fon1	I/Fon0	Vccon4	Vccon3	Vccon2	Vccon1	Vccon0
R/W	R/W	R/W	R/W	R/W	R/W	R/W	R/W	R/W
Reset	0	0	0	0	0	0	0	0

Bit	Name	Function
15	Testmode	Test mode enable 0 : Normal operation 1 : Enters test mode
14	VccC	Vcc (VPLCD) signal polarity control 0 : Active low 1 : Active high
13, 12	Reserved	Write 0 when write. 0 is returned when read
11	BiasCon	Bias (VPBIAS) signal polarity control 0 : Active low 1 : Active high
10	PowerC	Power control 0 : Off 1 : On
9 to 5	I/Fon(4:0)	Panel logic interface signals are turned on at this frame
4 to 0	Vccon(4:0)	Panel Vcc is turned on at this frame

26.4.21 LCDIMSKREG (0x0A00 0434)

Bit	15	14	13	12	11	10	9	8
Name	Reserved	Reserved	Reserved	Reserved	Reserved	Reserved	Reserved	Reserved
R/W	R	R	R	R	R	R	R	R
Reset	0	0	0	0	0	0	0	0

Bit	7	6	5	4	3	2	1	0
Name	Reserved	Reserved	Reserved	Reserved	Reserved	MVIReq	MFIFO OVERR	Reserved
R/W	R	R	R	R	R	R/W	R/W	R
Reset	0	0	0	0	0	0	0	0

Bit	Name	Function
15 to 3	Reserved	0 is returned when read
2	MVIReq	Vertical retrace interrupt request mask 0 : Mask 1 : Unmask
1	MFIFOOVERR	FIFO Overrun interrupt request mask 0 : Mask 1 : Unmask
0	Reserved	0 is returned when read

26.4.22 CPINDCTREG (0x0A00 047E)

Bit	15	14	13	12	11	10	9	8
Name	PalPage3	PalPage2	PalPage1	PalPage0	Reserved	Reserved	PalRDI	PalWrl
R/W	R/W	R/W	R/W	R/W	R	R	R/W	R/W
Reset	0	0	0	0	0	0	0	0

Bit	7	6	5	4	3	2	1	0
Name	PalIndex7	Palindex6	PalIndex5	PalIndex4	PalIndex3	PalIndex2	PalIndex1	PalIndex0
R/W	R/W	R/W	R/W	R/W	R/W	R/W	R/W	R/W
Reset	0	0	0	0	0	0	0	0

Bit	Name	Function
15 to 12	PalPage(3:0)	Palette page select used in 4 bit per pixel mode
11, 10	Reserved	0 is returned when read
9	PalRDI	Palette index read status 0: No change after read 1: Incremented by 1 after read
8	PalWrl	Palette index write status 0: No change after write 1: Incremented by 1 after write
7 to 0	PalIndex(7:0)	Palette index

26.4.23 CPALDATREG (0x0A0 0480)

Bit	31	30	29	28	27	26	25	24
Name	Reserved	Reserved	Reserved	Reserved	Reserved	Reserved	Reserved	Reserved
R/W	R	R	R	R	R	R	R	R
Reset	0	0	0	0	0	0	0	0

Bit	23	22	21	20	19	18	17	16
Name	Reserved	Reserved	Reserved	Reserved	Reserved	Reserved	PaData17	PaData16
R/W	R	R	R	R	R	R	R/W	R/W
Reset	0	0	0	0	0	0	Undefined	Undefined

Bit	15	14	13	12	11	10	9	8
Name	PaData15	PaData14	PaData13	PaData12	PaData11	PaData10	PaData9	PaData8
R/W	R/W	R/W	R/W	R/W	R/W	R/W	R/W	R/W
Reset	Undefined	Undefined	Undefined	Undefined	Undefined	Undefined	Undefined	Undefined

Bit	7	6	5	4	3	2	1	0
Name	PaData7	PaData6	PaData5	PaData4	PaData3	PaData2	PaData1	PaData0
R/W	R/W	R/W	R/W	R/W	R/W	R/W	R/W	R/W
Reset	Undefined	Undefined	Undefined	Undefined	Undefined	Undefined	Undefined	Undefined

Bit	Name	Function
31 to 18	Reserved	0 is returned when read
17 to 0	PaData(17:0)	Color palette data (6-6-6 format)

This register must be accessed in 32-bit unit.

[MEMO]

CHAPTER 27 MIPS III INSTRUCTION SET DETAILS

This chapter provides a detailed description of the operation of each VR4181 instruction in both 32- and 64-bit modes. The instructions are listed in alphabetical order.

27.1 Instruction Notation Conventions

In this chapter, all variable subfields in an instruction format (such as *rs*, *rt*, *immediate*, etc.) are shown in lowercase names.

For the sake of clarity, we sometimes use an alias for a variable subfield in the formats of specific instructions. For example, we use *rs = base* in the format for load and store instructions. Such an alias is always lower case, since it refers to a variable subfield.

Figures with the actual bit encoding for all the mnemonics are located at the end of this chapter (**27.6 CPU Instruction Opcode Bit Encoding**), and the bit encoding also accompanies each instruction.

In the instruction descriptions that follow, the Operation section describes the operation performed by each instruction using a high-level language notation. The VR4181 can operate as either a 32- or 64-bit microprocessor and the operation for both modes is included with the instruction description.

Special symbols used in the notation are described in Table 27-1.

Table 27-1. CPU Instruction Operation Notations

Symbol	Meaning
<-	Assignment.
	Bit string concatenation.
x^y	Replication of bit value x into a y -bit string. x is always a single-bit value.
$x_{y...z}$	Selection of bits y through z of bit string x . Little-endian bit notation is always used. If y is less than z , this expression is an empty (zero length) bit string.
+	2's complement or floating-point addition.
-	2's complement or floating-point subtraction.
*	2's complement or floating-point multiplication.
div	2's complement integer division.
mod	2's complement modulo.
/	Floating-point division.
<	2's complement less than comparison.
and	Bit-wise logical AND.
or	Bit-wise logical OR.
xor	Bit-wise logical XOR.
nor	Bit-wise logical NOR.
GPR [x]	General-Register x . The content of GPR [0] is always zero. Attempts to alter the content of GPR [0] have no effect.
CPR [z, x]	Coprocessor unit z , general register x .
CCR [z, x]	Coprocessor unit z , control register x .
COC [z]	Coprocessor unit z condition signal.
BigEndianMem	Big-endian mode as configured at reset (0 → Little, 1 → Big). Specifies the endianness of the memory interface (see Table 27-2), and the endianness of Kernel and Supervisor mode execution. However, this value is always 0 since the V_{R4181} supports the little endian order only.
ReverseEndian	Signal to reverse the endianness of load and store instructions. This feature is available in User mode only, and is effected by setting the RE bit of the Status register. Thus, ReverseEndian may be computed as (SR25 and User mode). However, this value is always 0 since the V_{R4181} supports the little endian order only.
BigEndianCPU	The endianness for load and store instructions (0 → Little, 1 → Big). In User mode, this endianness may be reversed by setting SR25. Thus, BigEndianCPU may be computed as BigEndianMem XOR ReverseEndian. However, this value is always 0 since the V_{R4181} supports the little endian order only.
$T + i :$	Indicates the time steps between operations. Each of the statements within a time step are defined to be executed in sequential order (as modified by conditional and loop constructs). Operations which are marked $T + i :$ are executed at instruction cycle i relative to the start of execution of the instruction. Thus, an instruction which starts at time j executes operations marked $T + i :$ at time $i + j$. The interpretation of the order of execution between two instructions or two operations that execute at the same time should be pessimistic; the order is not defined.

(1) Instruction Notation Examples

The following examples illustrate the application of some of the instruction notation conventions:

Example #1:

$$\text{GPR [rt]} \leftarrow \text{immediate} \parallel 0^{16}$$

Sixteen zero bits are concatenated with an immediate value (typically 16 bits), and the 32-bit string (with the lower 16 bits set to zero) is assigned to General-purpose register *rt*.

Example #2:

$$(\text{immediate}_{15})^{16} \parallel \text{immediate}_{15..0}$$

Bit 15 (the sign bit) of an immediate value is extended for 16 bit positions, and the result is concatenated with bits 15 through 0 of the immediate value to form a 32-bit sign extended value.

27.2 Load and Store Instructions

In the Vr4181 implementation, the instruction immediately following a load may use the loaded contents of the register. In such cases, the hardware interlocks, requiring additional real cycles, so scheduling load delay slots is still desirable, although not required for functional code.

In the load and store descriptions, the functions listed in Table 27-2 are used to summarize the handling of virtual addresses and physical memory.

Table 27-2. Load and Store Common Functions

Function	Meaning
Address Translation	Uses the TLB to find the physical address given the virtual address. The function fails and an exception is taken if the required translation is not present in the TLB.
Load Memory	Uses the cache and main memory to find the contents of the word containing the specified physical address. The low-order three bits of the address and the Access Type field indicate which of each of the four bytes within the data word need to be returned. If the cache is enabled for this access, the entire word is returned and loaded into the cache. If the specified data is short of word length, the data position to which the contents of the specified data is stored is determined considering the endian mode and reverse endian mode.
Store Memory	Uses the cache, write buffer, and main memory to store the word or part of word specified as data in the word containing the specified physical address. The low-order three bits of the address and the Access Type field indicate which of each of the four bytes within the data word should be stored. If the specified data is short of word length, the data position to which the contents of the specified data is stored is determined considering the endian mode and reverse endian mode.

As shown in Table 27-3, the Access Type field indicates the size of the data item to be loaded or stored. Regardless of access type or byte-numbering order (endianness), the address specifies the byte that has the smallest byte address in the addressed field. This is the rightmost byte in the VR4181 since it supports the little-endian order only.

Table 27-3. Access Type Specifications for Loads/Stores

Access Type Mnemonic	Value	Meaning
DOUBLEWORD	7	8 bytes (64 bits)
SEPTIBYTE	6	7 bytes (56 bits)
SEXTIBYTE	5	6 bytes (48 bits)
QUINTIBYTE	4	5 bytes (40 bits)
WORD	3	4 bytes (32 bits)
TRIPLEBYTE	2	3 bytes (24 bits)
HALFWORD	1	2 bytes (16 bits)
BYTE	0	1 byte (8 bits)

The bytes within the addressed doubleword that are used can be determined directly from the access type and the three low-order bits of the address.

27.3 Jump and Branch Instructions

All jump and branch instructions have an architectural delay of exactly one instruction. That is, the instruction immediately following a jump or branch (that is, occupying the delay slot) is always executed while the target instruction is being fetched from storage. A delay slot may not itself be occupied by a jump or branch instruction; however, this error is not detected and the results of such an operation are undefined.

If an exception or interrupt prevents the completion of a legal instruction during a delay slot, the hardware sets the EPC register to point at the jump or branch instruction that precedes it. When the code is restarted, both the jump or branch instructions and the instruction in the delay slot are reexecuted.

Because jump and branch instructions may be restarted after exceptions or interrupts, they must be restartable. Therefore, when a jump or branch instruction stores a return link value, register *r31* (the register in which the link is stored) may not be used as a source register.

Since instructions must be word-aligned, a Jump Register or Jump and Link Register instruction must use a register which contains an address whose two low-order bits (low-order one bit in the 16-bit mode) are zero. If these low-order bits are not zero, an address exception will occur when the jump target instruction is subsequently fetched.

27.4 System Control Coprocessor (CP0) Instructions

There are some special limitations imposed on operations involving CP0 that is incorporated within the CPU. Although load and store instructions to transfer data to/from coprocessors and to move control to/from coprocessor instructions are generally permitted by the MIPS architecture, CP0 is given a somewhat protected status since it has responsibility for exception handling and memory management. Therefore, the move to/from coprocessor instructions are the only valid mechanism for writing to and reading from the CP0 registers.

Several CP0 instructions are defined to directly read, write, and probe TLB entries and to modify the operating modes in preparation for returning to User mode or interrupt-enabled states.

27.5 CPU Instruction

This section describes the functions of CPU instructions in detail for both 32-bit address mode and 64-bit address mode.

The exception that may occur by executing each instruction is shown in the last of each instruction's description. For details of exceptions and their processes, see **CHAPTER 7 EXCEPTION PROCESSING**.

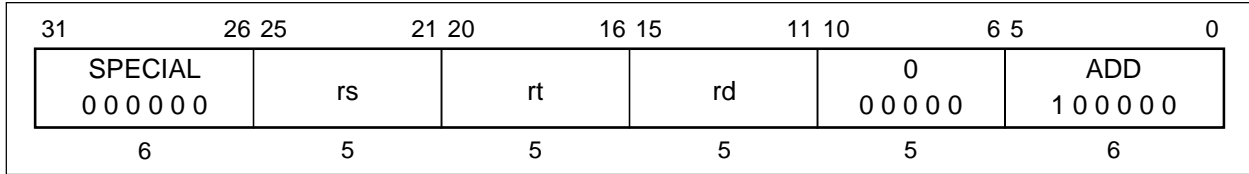
ADD**Add****ADD****Format:**

ADD rd, rs, rt

Description:

The contents of general register *rs* and the contents of general register *rt* are added to form the result. The result is placed into general register *rd*. In 64-bit mode, the operands must be valid sign-extended, 32-bit values.

An overflow exception occurs if the carries out of bits 30 and 31 differ (2's complement overflow). The destination register *rd* is not modified when an integer overflow exception occurs.

Operation:

32	T: GPR [rd] ← GPR [rs] + GPR [rt]
64	T: temp ← GPR [rs] + GPR [rt] GPR [rd] ← (temp ₃₁) ³² temp _{31...0}

Exceptions:

Integer overflow exception

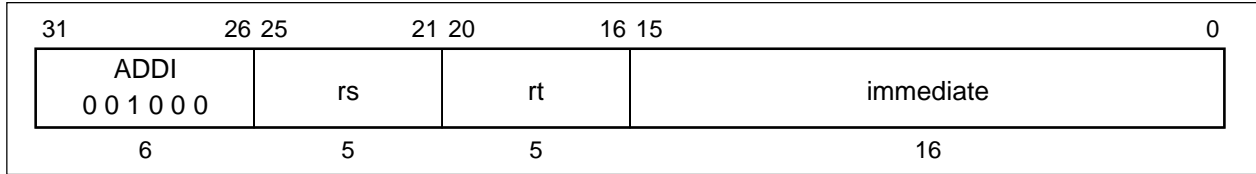
ADDI**Add Immediate****ADDI****Format:**ADDI *rt*, *rs*, *immediate***Description:**

The 16-bit *immediate* is sign-extended and added to the contents of general register *rs* to form the result. The result is placed into general register *rt*. In 64-bit mode, the operand must be valid sign-extended, 32-bit values. An overflow exception occurs if carries out of bits 30 and 31 differ (2's complement overflow). The destination register *rt* is not modified when an integer overflow exception occurs.

Operation:

32	T: $GPR[rt] \leftarrow GPR[rs] + (immediate_{15})^{16} \parallel immediate_{15..0}$
64	T: $temp \leftarrow GPR[rs] + (immediate_{15})^{48} \parallel immediate_{15..0}$ $GPR[rt] \leftarrow (temp_{31})^{32} \parallel temp_{31..0}$

Exceptions:

Integer overflow exception

ADDIU Add Immediate Unsigned ADDIU

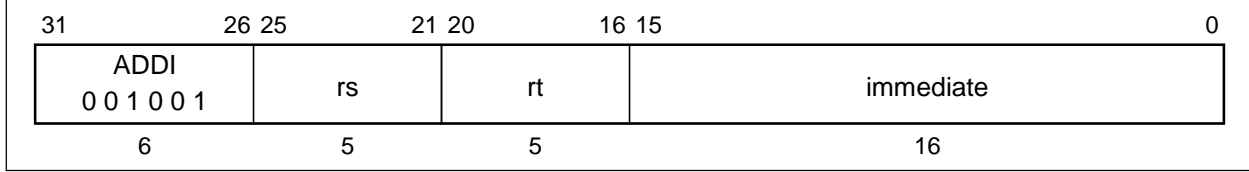
**Format:**ADDIU *rt*, *rs*, *immediate***Description:**

The 16-bit *immediate* is sign-extended and added to the contents of general register *rs* to form the result. The result is placed into general register *rt*. No integer overflow exception occurs under any circumstances. In 64-bit mode, the operand must be valid sign-extended, 32-bit values.

The only difference between this instruction and the ADDI instruction is that ADDIU never causes an integer overflow exception.

Operation:

32 T: $\text{GPR}[rt] \leftarrow \text{GPR}[rs] + (\text{immediate}_{15})^{16} \parallel \text{immediate}_{15..0}$

64 T: $\text{temp} \leftarrow \text{GPR}[rs] + (\text{immediate}_{15})^{48} \parallel \text{immediate}_{15..0}$
 $\text{GPR}[rt] \leftarrow (\text{temp}_{31})^{32} \parallel \text{temp}_{31..0}$

Exceptions:

None

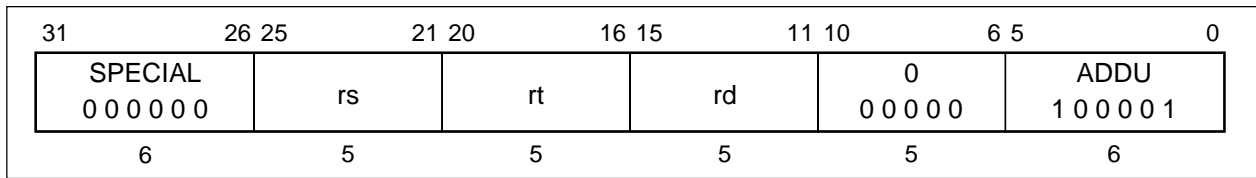
ADDU**Add Unsigned****ADDU****Format:**

ADDU rd, rs, rt

Description:

The contents of general register *rs* and the contents of general register *rt* are added to form the result. The result is placed into general register *rd*. No integer overflow exception occurs under any circumstances. In 64-bit mode, the operands must be valid sign-extended, 32-bit values.

The only difference between this instruction and the ADD instruction is that ADDU never causes an integer overflow exception.

Operation:

32	T: GPR [rt] ← GPR [rs] + GPR [rt]
64	T: temp ← GPR [rs] + GPR [rt] GPR [rd] ← (temp ₃₁) ³² temp _{31...0}

Exceptions:

None

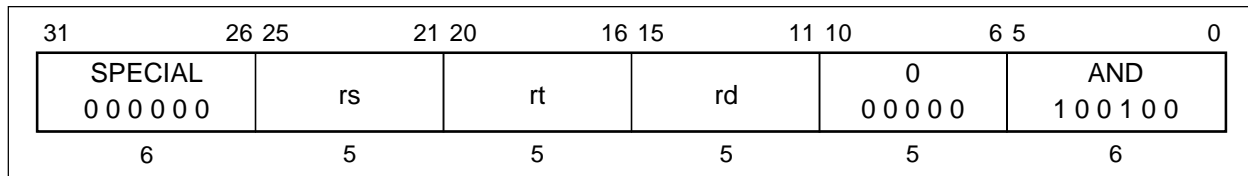
AND**And****AND****Format:**

AND rd, rs, rt

Description:

The contents of general register *rs* are combined with the contents of general register *rt* in a bit-wise logical AND operation. The result is placed into general register *rd*.

Operation:

32	T: GPR [rd] ← GPR [rs] and GPR [rt]
64	T: GPR [rd] ← GPR [rs] and GPR [rt]

Exceptions:

None

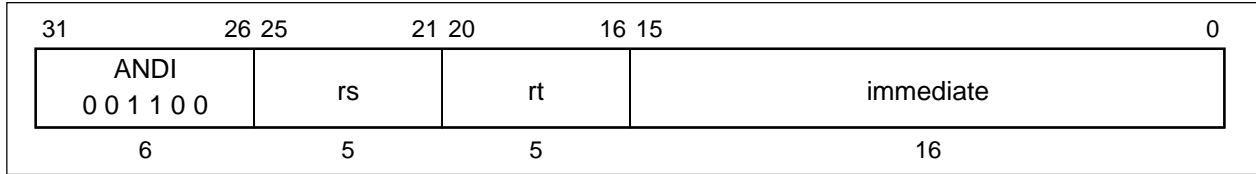
ANDI**And Immediate****ANDI****Format:**ANDI *rt*, *rs*, *immediate***Description:**

The 16-bit *immediate* is zero-extended and combined with the contents of general register *rs* in a bit-wise logical AND operation. The result is placed into general register *rt*.

Operation:

32	T: $GPR [rt] \leftarrow 0^{16} \parallel (\text{immediate and } GPR [rs]_{15..0})$
64	T: $GPR [rt] \leftarrow 0^{48} \parallel (\text{immediate and } GPR [rs]_{15..0})$

Exceptions:

None

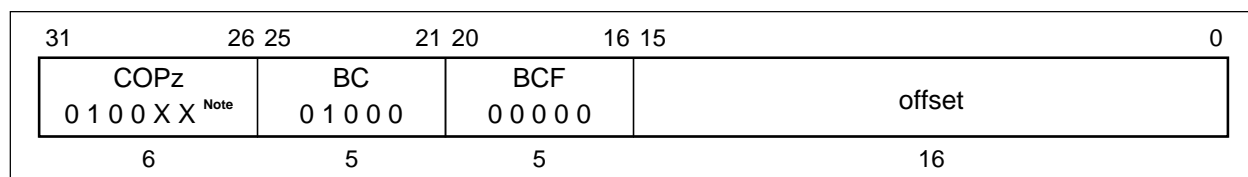
BC0F**Branch on Coprocessor 0 False****BC0F****Format:**

BC0F offset

Description:

A branch target address is computed from the sum of the address of the instruction in the delay slot and the 16-bit *offset*, shifted left two bits and sign-extended. If coprocessor 0's condition signal (CpCond: Status register bit-18 CH field), as sampled during the previous instruction, is false, then the program branches to the target address with a delay of one instruction.

Because the condition line is sampled during the previous instruction, there must be at least one instruction between this instruction and a coprocessor instruction that changes the condition line.

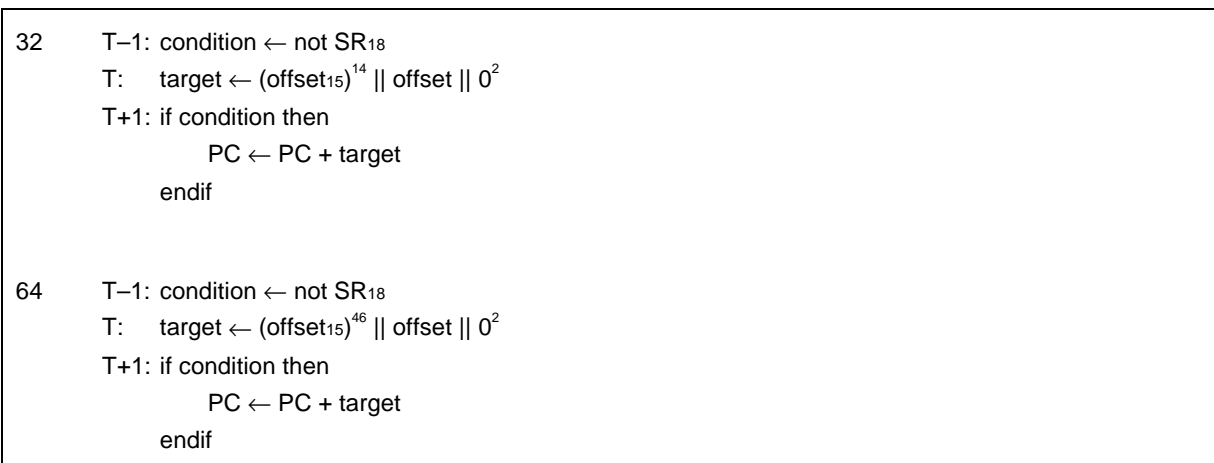
Operation:**Exceptions:**

Coprocessor unusable exception

Note See the opcode table below, or **27.6 CPU Instruction Opcode Bit Encoding**.

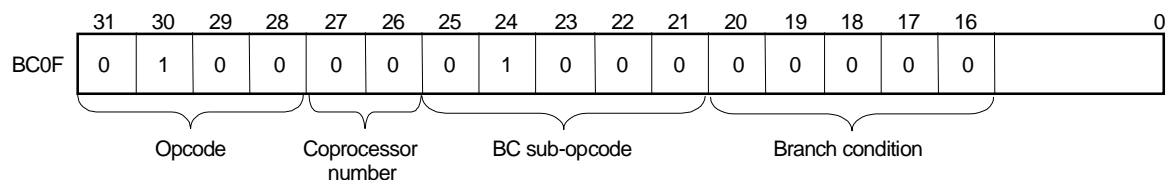
Opcode Table:

BC0FL Branch on Coprocessor 0 False Likely BFC0FL

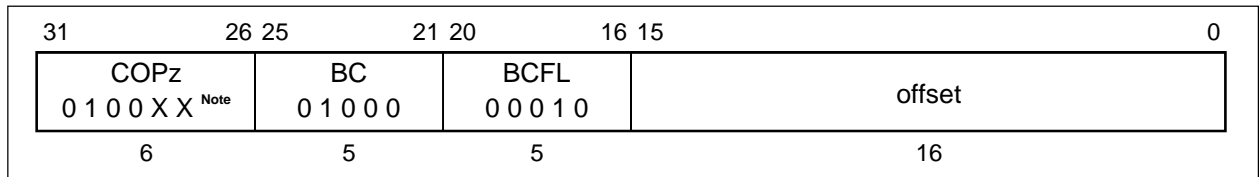

Format:

BC0FL offset

Description:

A branch target address is computed from the sum of the address of the instruction in the delay slot and the 16-bit *offset*, shifted left two bits and sign-extended. If the contents of coprocessor 0's condition line, as sampled during the previous instruction, is false, the target address is branched to with a delay of one instruction.

If the conditional branch is not taken, the instruction in the branch delay slot is nullified.

Because the condition line is sampled during the previous instruction, there must be at least one instruction between this instruction and a coprocessor instruction that changes the condition line.

Operation:

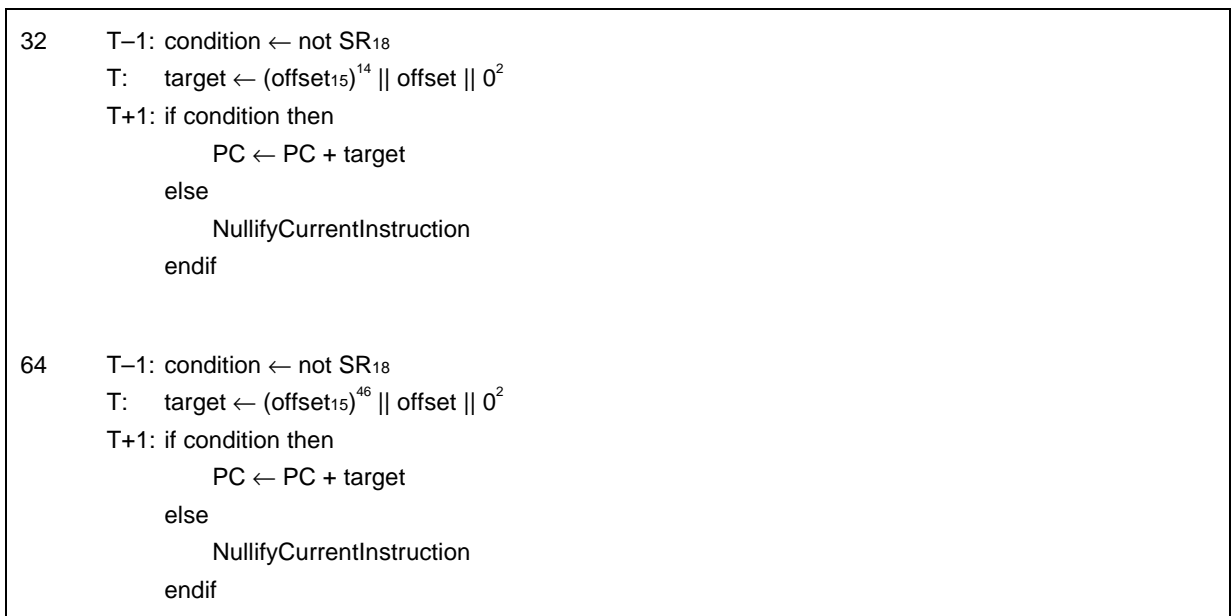

Exceptions:

Coprocessor unusable exception

Note See the opcode table below, or **27.6 CPU Instruction Opcode Bit Encoding**.

Opcode Table:

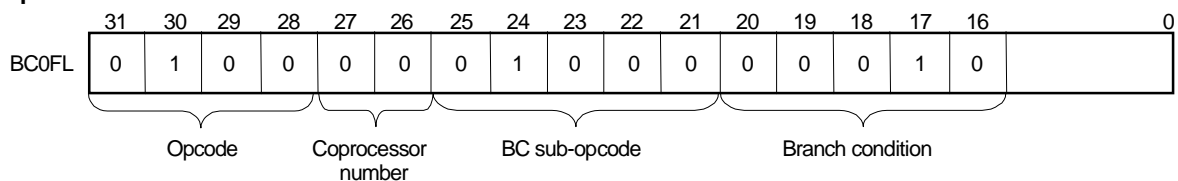

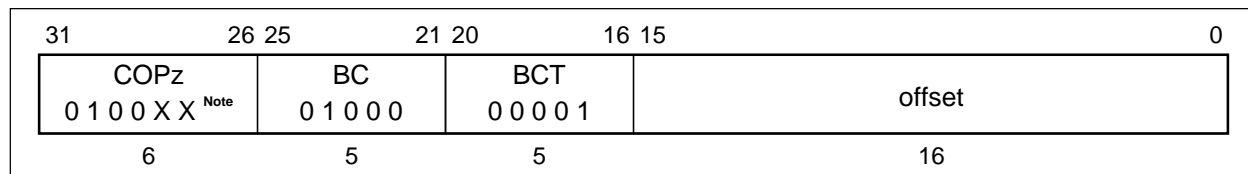
BC0T**Branch on Coprocessor 0 True****BC0T****Format:**

BC0T offset

Description:

A branch target address is computed from the sum of the address of the instruction in the delay slot and the 16-bit *offset*, shifted left two bits and sign-extended. If the coprocessor 0's condition signal (CpCond: Status register bit-18 CH field) is true, then the program branches to the target address, with a delay of one instruction.

Because the condition line is sampled during the previous instruction, there must be at least one instruction between this instruction and a coprocessor instruction that changes the condition line.

Operation:

```

32   T-1: condition ← SR18
      T:  target ← (offset15)14 || offset || 02
      T+1: if condition then
           PC ← PC + target
        endif

64   T-1: condition ← SR18
      T:  target ← (offset15)46 || offset || 02
      T+1: if condition then
           PC ← PC + target
        endif

```

Exceptions:

Coprocessor unusable exception

Note See the opcode table below, or **27.6 CPU Instruction Opcode Bit Encoding**.

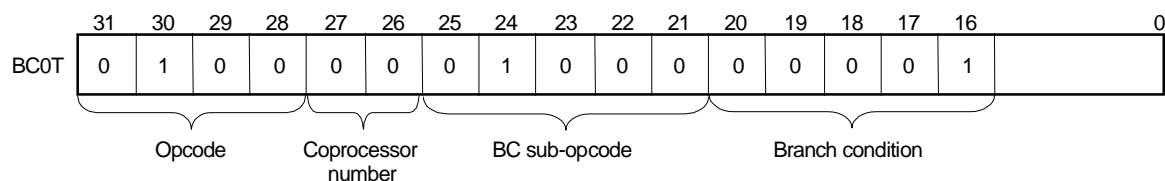
Opcode Table:

BC0TL Branch on Coprocessor 0 True Likely BC0TL

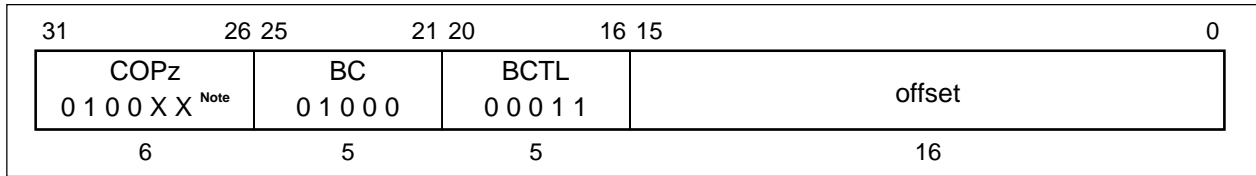

Format:

BC0TL offset

Description:

A branch target address is computed from the sum of the address of the instruction in the delay slot and the 16-bit *offset*, shifted left two bits and sign-extended. If the contents of coprocessor 0's condition line, as sampled during the previous instruction, is true, the target address is branched to with a delay of one instruction.

If the conditional branch is not taken, the instruction in the branch delay slot is nullified.

Because the condition line is sampled during the previous instruction, there must be at least one instruction between this instruction and a coprocessor instruction that changes the condition line.

Operation:

```

32   T-1: condition ← SR18
      T:   target ← (offset15)14 || offset || 02
      T+1: if condition then
            PC ← PC + target
          else
            NullifyCurrentInstruction
          endif

64   T-1: condition ← SR18
      T:   target ← (offset15)46 || offset || 02
      T+1: if condition then
            PC ← PC + target
          else
            NullifyCurrentInstruction
          endif
    
```

Exceptions:

Coprocessor unusable exception

Note See the opcode table below, or **27.6 CPU Instruction Opcode Bit Encoding**.

Opcode Table:

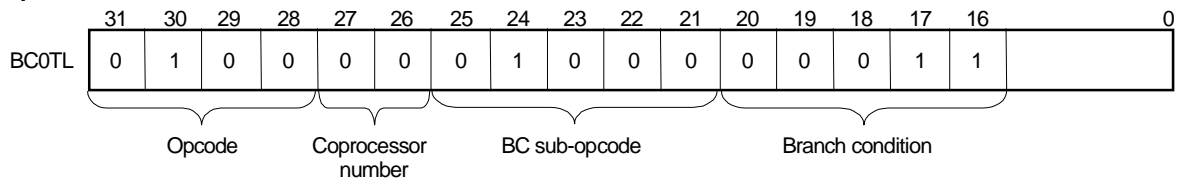

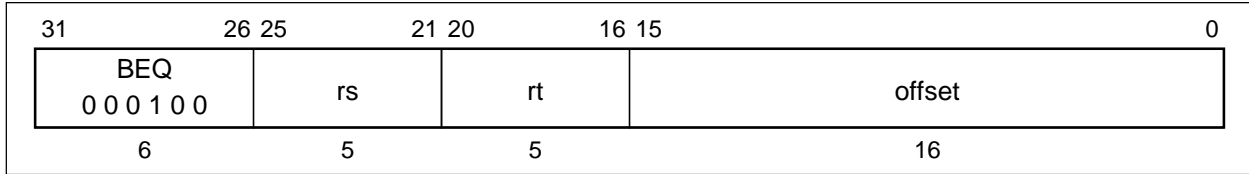
BEQ**Branch on Equal****BEQ****Format:**BEQ *rs*, *rt*, *offset***Description:**

A branch target address is computed from the sum of the address of the instruction in the delay slot and the 16-bit *offset*, shifted left two bits and sign-extended. The contents of general register *rs* and the contents of general register *rt* are compared. If the two registers are equal, then the program branches to the target address, with a delay of one instruction.

Operation:

32	<p>T: $\text{target} \leftarrow (\text{offset}_{15})^{14} \parallel \text{offset} \parallel 0^2$ $\text{condition} \leftarrow (\text{GPR}[\text{rs}] = \text{GPR}[\text{rt}])$ T+1: if condition then $\text{PC} \leftarrow \text{PC} + \text{target}$ endif</p>
64	<p>T: $\text{target} \leftarrow (\text{offset}_{15})^{46} \parallel \text{offset} \parallel 0^2$ $\text{condition} \leftarrow (\text{GPR}[\text{rs}] = \text{GPR}[\text{rt}])$ T+1: if condition then $\text{PC} \leftarrow \text{PC} + \text{target}$ endif</p>

Exceptions:

None

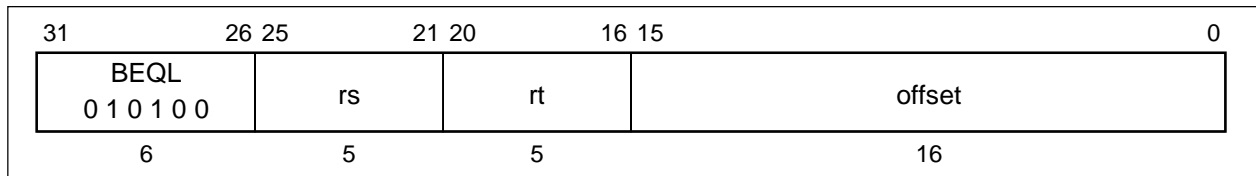
BEQL**Branch on Equal Likely****BEQL****Format:**

BEQL rs, rt, offset

Description:

A branch target address is computed from the sum of the address of the instruction in the delay slot and the 16-bit offset, shifted left two bits and sign-extended. The contents of general register *rs* and the contents of general register *rt* are compared. If the two registers are equal, the target address is branched to, with a delay of one instruction. If the conditional branch is not taken, the instruction in the branch delay slot is nullified.

Operation:

```

32   T:  target ← (offset15)14 || offset || 02
      condition ← (GPR [rs] = GPR [rt])
      T+1: if condition then
            PC ← PC + target
          else
            NullifyCurrentInstruction
          endif

64   T:  target ← (offset15)46 || offset || 02
      condition ← (GPR [rs] = GPR [rt])
      T+1: if condition then
            PC ← PC + target
          else
            NullifyCurrentInstruction
          endif

```

Exceptions:

None

BGEZ Branch on Greater than or Equal to Zero BGEZ

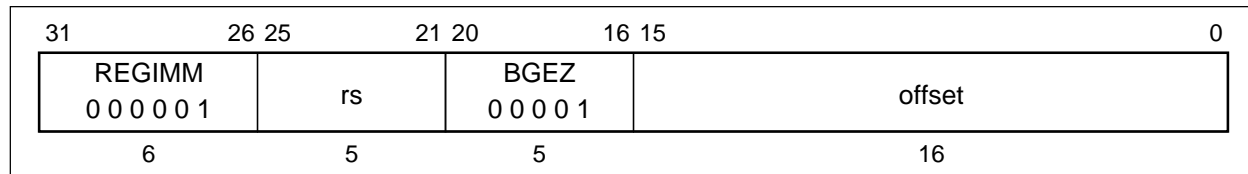
**Format:**

BGEZ rs, offset

Description:

A branch target address is computed from the sum of the address of the instruction in the delay slot and the 16-bit *offset*, shifted left two bits and sign-extended. If the contents of general register *rs* have the sign bit cleared, then the program branches to the target address, with a delay of one instruction.

Operation:

32	T: $\text{target} \leftarrow (\text{offset}_{15})^{14} \parallel \text{offset} \parallel 0^2$ $\text{condition} \leftarrow (\text{GPR}[\text{rs}]_{31} = 0)$ T+1: if condition then $\text{PC} \leftarrow \text{PC} + \text{target}$ endif
64	T: $\text{target} \leftarrow (\text{offset}_{15})^{46} \parallel \text{offset} \parallel 0^2$ $\text{condition} \leftarrow (\text{GPR}[\text{rs}]_{63} = 0)$ T+1: if condition then $\text{PC} \leftarrow \text{PC} + \text{target}$ endif

Exceptions:

None

BGEZAL Branch on Greater than or Equal to Zero And Link BGEZAL

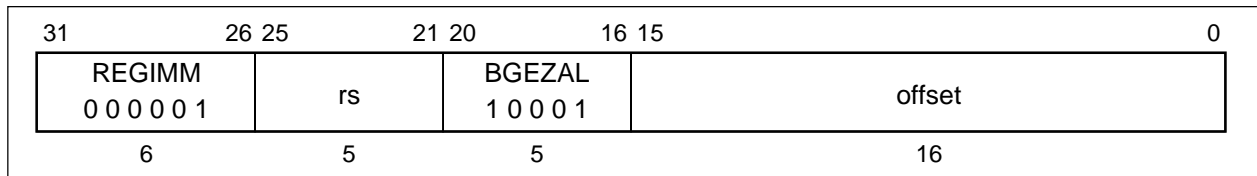
**Format:**

BGEZAL rs, offset

Description:

A branch target address is computed from the sum of the address of the instruction in the delay slot and the 16-bit *offset*, shifted left two bits and sign-extended. Unconditionally, the address of the instruction after the delay slot is placed in the link register, *r31*. If the contents of general register *rs* have the sign bit cleared, then the program branches to the target address, with a delay of one instruction.

General register *rs* may not be general register *r31*, because such an instruction is not restartable. An attempt to execute this instruction is not trapped, however.

Operation:

32	T: $target \leftarrow (offset_{15})^{14} \parallel offset \parallel 0^2$ $condition \leftarrow (GPR[rs]_{31} = 0)$ $GPR[31] \leftarrow PC + 8$ T+1: if condition then $PC \leftarrow PC + target$ endif
64	T: $target \leftarrow (offset_{15})^{46} \parallel offset \parallel 0^2$ $condition \leftarrow (GPR[rs]_{63} = 0)$ $GPR[31] \leftarrow PC + 8$ T+1: if condition then $PC \leftarrow PC + target$ endif

Exceptions:

None

BGEZALL Branch on Greater than or Equal to Zero And Link Likely BGEZALL

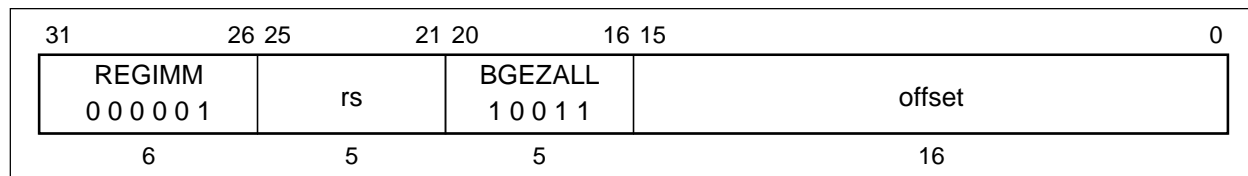
**Format:**

BGEZALL rs, offset

Description:

A branch target address is computed from the sum of the address of the instruction in the delay slot and the 16-bit *offset*, shifted left two bits and sign-extended. Unconditionally, the address of the instruction after the delay slot is placed in the link register, *r31*. If the contents of general register *rs* have the sign bit cleared, then the program branches to the target address, with a delay of one instruction. General register *rs* may not be general register *31*, because such an instruction is not restartable. An attempt to execute this instruction is not trapped, however. If the conditional branch is not taken, the instruction in the branch delay slot is nullified.

Operation:

```

32   T:  target ← (offset15)14 || offset || 02
      condition ← (GPR [rs]31 = 0)
      GPR [31] ← PC + 8
      T+1: if condition then
            PC ← PC + target
          else
            NullifyCurrentInstruction
          endif

64   T:  target ← (offset15)46 || offset || 02
      condition ← (GPR [rs]63 = 0)
      GPR [31] ← PC + 8
      T+1: if condition then
            PC ← PC + target
          else
            NullifyCurrentInstruction
          endif

```

Exceptions:

None

BGEZL Branch on Greater than or Equal to Zero Likely BGEZL

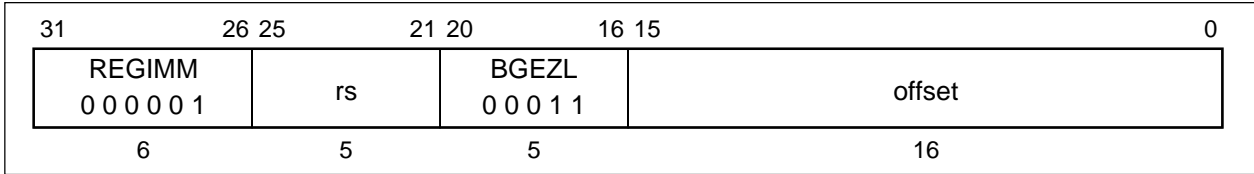
**Format:**

BGEZL rs, offset

Description:

A branch target address is computed from the sum of the address of the instruction in the delay slot and the 16-bit *offset*, shifted left two bits and sign-extended. If the contents of general register *rs* have the sign bit cleared, then the program branches to the target address, with a delay of one instruction. If the conditional branch is not taken, the instruction in the branch delay slot is nullified.

Operation:

32	T: target \leftarrow (offset ₁₅) ¹⁴ offset 0 ² condition \leftarrow (GPR [rs] ₃₁ = 0) T+1: if condition then PC \leftarrow PC + target else NullifyCurrentInstruction endif
64	T: target \leftarrow (offset ₁₅) ⁴⁶ offset 0 ² condition \leftarrow (GPR [rs] ₆₃ = 0) T+1: if condition then PC \leftarrow PC + target else NullifyCurrentInstruction endif

Exceptions:

None

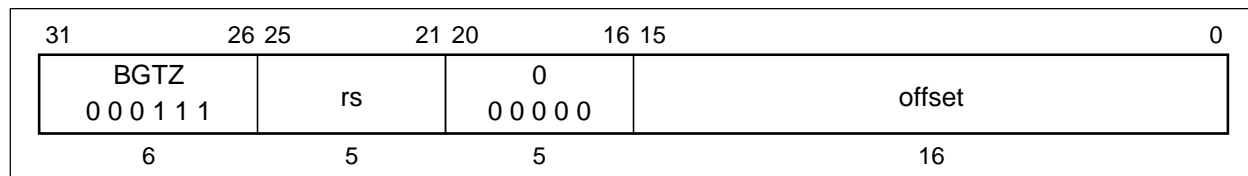
BGTZ**Branch on Greater than Zero****BGTZ****Format:**

BGTZ rs, offset

Description:

A branch target address is computed from the sum of the address of the instruction in the delay slot and the 16-bit *offset*, shifted left two bits and sign-extended. The contents of general register *rs* are compared to zero. If the contents of general register *rs* have the sign bit cleared and are not equal to zero, then the program branches to the target address, with a delay of one instruction.

Operation:

32	T: $\text{target} \leftarrow (\text{offset}_{15})^{14} \parallel \text{offset} \parallel 0^2$ $\text{condition} \leftarrow (\text{GPR}[\text{rs}]_{31} = 0) \text{ or } (\text{GPR}[\text{rs}] \neq 0^{32})$ T+1: if condition then PC \leftarrow PC + target endif
64	T: $\text{target} \leftarrow (\text{offset}_{15})^{46} \parallel \text{offset} \parallel 0^2$ $\text{condition} \leftarrow (\text{GPR}[\text{rs}]_{63} = 0) \text{ or } (\text{GPR}[\text{rs}] \neq 0^{64})$ T+1: if condition then PC \leftarrow PC + target endif

Exceptions:

None

BGTZL Branch on Greater than Zero Likely BGTZL

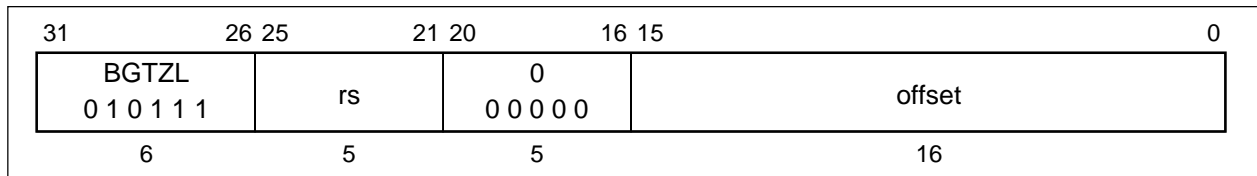
**Format:**

BGTZL rs, offset

Description:

A branch target address is computed from the sum of the address of the instruction in the delay slot and the 16-bit *offset*, shifted left two bits and sign-extended. The contents of general register *rs* are compared to zero. If the contents of general register *rs* have the sign bit cleared and are not equal to zero, then the program branches to the target address, with a delay of one instruction. If the conditional branch is not taken, the instruction in the branch delay slot is nullified.

Operation:

32	T: $\text{target} \leftarrow (\text{offset}_{15})^{14} \parallel \text{offset} \parallel 0^2$ $\text{condition} \leftarrow (\text{GPR}[\text{rs}]_{31} = 0) \text{ or } (\text{GPR}[\text{rs}] \neq 0^{32})$ T+1: if condition then PC \leftarrow PC + target else NullifyCurrentInstruction endif
64	T: $\text{target} \leftarrow (\text{offset}_{15})^{46} \parallel \text{offset} \parallel 0^2$ $\text{condition} \leftarrow (\text{GPR}[\text{rs}]_{63} = 0) \text{ or } (\text{GPR}[\text{rs}] \neq 0^{64})$ T+1: if condition then PC \leftarrow PC + target else NullifyCurrentInstruction endif

Exceptions:

None

BLEZ Branch on Less than or Equal to Zero BLEZ

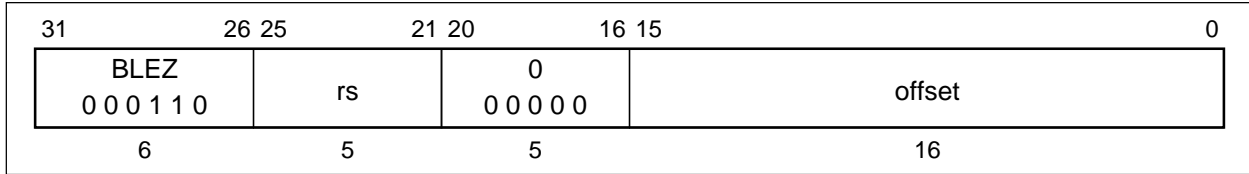
**Format:**

BLEZ rs, offset

Description:

A branch target address is computed from the sum of the address of the instruction in the delay slot and the 16-bit *offset*, shifted left two bits and sign-extended. The contents of general register *rs* are compared to zero. If the contents of general register *rs* have the sign bit set, or are equal to zero, then the program branches to the target address, with a delay of one instruction.

Operation:

32	T: $\text{target} \leftarrow (\text{offset}_{15})^{14} \parallel \text{offset} \parallel 0^2$ $\text{condition} \leftarrow (\text{GPR}[\text{rs}]_{31} = 1) \text{ or } (\text{GPR}[\text{rs}] = 0^{32})$ T+1: if condition then PC \leftarrow PC + target endif
64	T: $\text{target} \leftarrow (\text{offset}_{15})^{46} \parallel \text{offset} \parallel 0^2$ $\text{condition} \leftarrow (\text{GPR}[\text{rs}]_{63} = 1) \text{ or } (\text{GPR}[\text{rs}] = 0^{64})$ T+1: if condition then PC \leftarrow PC + target endif

Exceptions:

None

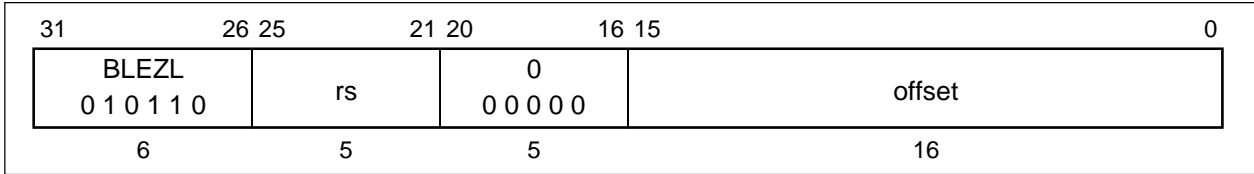
BLEZL Branch on Less than or Equal to Zero Likely **BLEZL****Format:**

BLEZL rs, offset

Description:

A branch target address is computed from the sum of the address of the instruction in the delay slot and the 16-bit *offset*, shifted left two bits and sign-extended. The contents of general register *rs* is compared to zero. If the contents of general register *rs* have the sign bit set, or are equal to zero, then the program branches to the target address, with a delay of one instruction.

If the conditional branch is not taken, the instruction in the branch delay slot is nullified.

Operation:

32	<p>T: $\text{target} \leftarrow (\text{offset}_{15})^{14} \parallel \text{offset} \parallel 0^2$ $\text{condition} \leftarrow (\text{GPR}[\text{rs}]_{31} = 1) \text{ or } (\text{GPR}[\text{rs}] = 0^{32})$</p> <p>T+1: if condition then PC \leftarrow PC + target else NullifyCurrentInstruction endif</p>
64	<p>T: $\text{target} \leftarrow (\text{offset}_{15})^{46} \parallel \text{offset} \parallel 0^2$ $\text{condition} \leftarrow (\text{GPR}[\text{rs}]_{63} = 1) \text{ or } (\text{GPR}[\text{rs}] = 0^{64})$</p> <p>T+1: if condition then PC \leftarrow PC + target else NullifyCurrentInstruction endif</p>

Exceptions:

None

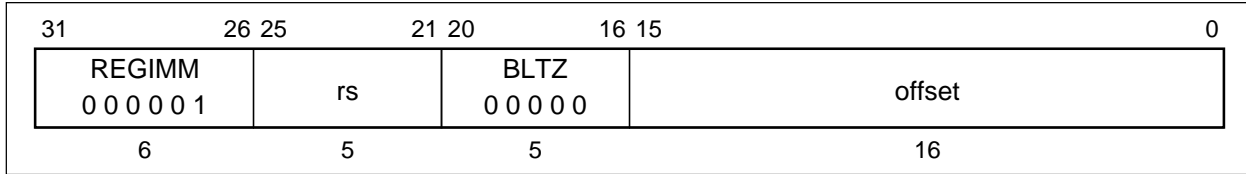
BLTZ**Branch on Less than Zero****BLTZ****Format:**

BLTZ rs, offset

Description:

A branch target address is computed from the sum of the address of the instruction in the delay slot and the 16-bit *offset*, shifted left two bits and sign-extended. If the contents of general register *rs* have the sign bit set, then the program branches to the target address, with a delay of one instruction.

Operation:

32	T: $\text{target} \leftarrow (\text{offset}_{15})^{14} \parallel \text{offset} \parallel 0^2$ $\text{condition} \leftarrow (\text{GPR}[\text{rs}]_{31} = 1)$ T+1: if condition then PC \leftarrow PC + target endif
64	T: $\text{target} \leftarrow (\text{offset}_{15})^{46} \parallel \text{offset} \parallel 0^2$ $\text{condition} \leftarrow (\text{GPR}[\text{rs}]_{63} = 1)$ T+1: if condition then PC \leftarrow PC + target endif

Exceptions:

None

BLTZAL Branch on Less than Zero and Link BLTZAL

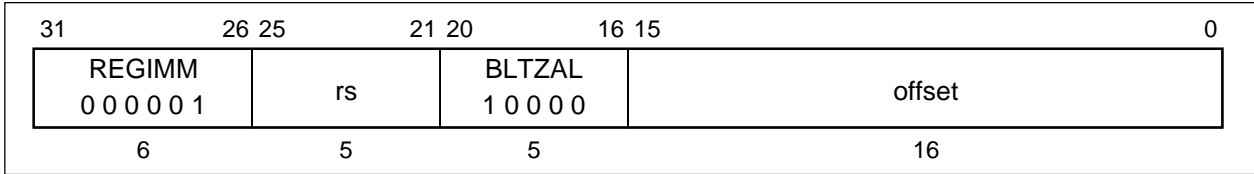
**Format:**

BLTZAL rs, offset

Description:

A branch target address is computed from the sum of the address of the instruction in the delay slot and the 16-bit *offset*, shifted left two bits and sign-extended. Unconditionally, the address of the instruction after the delay slot is placed in the link register, *r31*. If the contents of general register *rs* have the sign bit set, then the program branches to the target address, with a delay of one instruction.

General register *rs* may not be general register *31*, because such an instruction is not restartable. An attempt to execute this instruction with register *31* specified as *rs* is not trapped, however.

Operation:

32	T: $\text{target} \leftarrow (\text{offset}_{15})^{14} \parallel \text{offset} \parallel 0^2$ $\text{condition} \leftarrow (\text{GPR}[\text{rs}]_{31} = 1)$ $\text{GPR}[31] \leftarrow \text{PC} + 8$ T+1: if condition then $\text{PC} \leftarrow \text{PC} + \text{target}$ endif
64	T: $\text{target} \leftarrow (\text{offset}_{15})^{46} \parallel \text{offset} \parallel 0^2$ $\text{condition} \leftarrow (\text{GPR}[\text{rs}]_{63} = 1)$ $\text{GPR}[31] \leftarrow \text{PC} + 8$ T+1: if condition then $\text{PC} \leftarrow \text{PC} + \text{target}$ endif

Exceptions:

None

BLTZALL Branch on Less than Zero and Link Likely BLTZALL

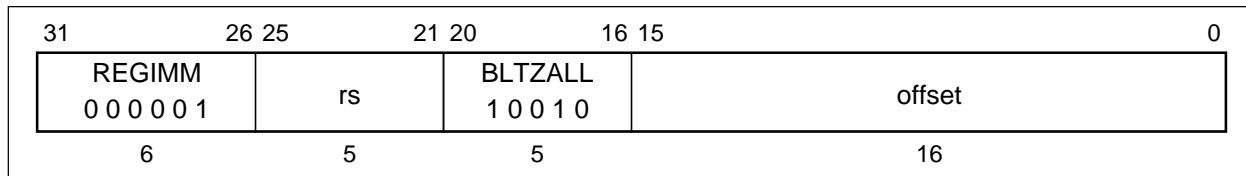
**Format:**

BLTZALL rs, offset

Description:

A branch target address is computed from the sum of the address of the instruction in the delay slot and the 16-bit *offset*, shifted left two bits and sign-extended. Unconditionally, the address of the instruction after the delay slot is placed in the link register, *r31*. If the contents of general register *rs* have the sign bit set, then the program branches to the target address, with a delay of one instruction.

General register *rs* may not be general register 31, because such an instruction is not restartable. An attempt to execute this instruction with register 31 specified as *rs* is not trapped, however. If the conditional branch is not taken, the instruction in the branch delay slot is nullified.

Operation:

```

32   T:   target ← (offset15)14 || offset || 02
       condition ← (GPR [rs]31 = 1)
       GPR [31] ← PC + 8
       T+1: if condition then
           PC ← PC + target
       else
           NullifyCurrentInstruction
       endif

64   T:   target ← (offset15)46 || offset || 02
       condition ← (GPR [rs]63 = 1)
       GPR [31] ← PC + 8
       T+1: if condition then
           PC ← PC + target
       else
           NullifyCurrentInstruction
       endif

```

Exceptions:

None

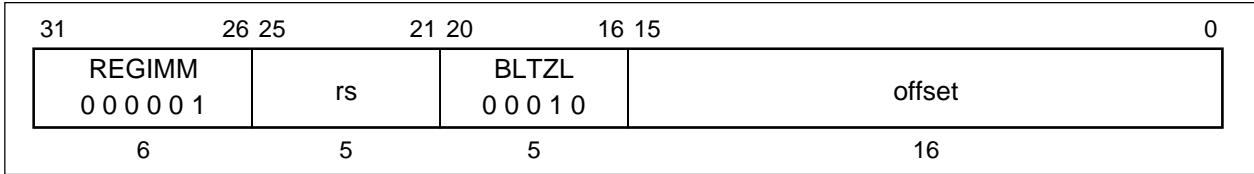
BLTZL**Branch on Less than Zero Likely****BLTZL****Format:**

BLTZ rs, offset

Description:

A branch target address is computed from the sum of the address of the instruction in the delay slot and the 16-bit *offset*, shifted left two bits and sign-extended. If the contents of general register *rs* have the sign bit set, then the program branches to the target address, with a delay of one instruction. If the conditional branch is not taken, the instruction in the branch delay slot is nullified.

Operation:

32	T: target \leftarrow (offset ₁₅) ¹⁴ offset 0 ² condition \leftarrow (GPR [rs] ₃₁ = 1) T+1: if condition then PC \leftarrow PC + target else NullifyCurrentInstruction endif
64	T: target \leftarrow (offset ₁₅) ⁴⁶ offset 0 ² condition \leftarrow (GPR [rs] ₆₃ = 1) T+1: if condition then PC \leftarrow PC + target else NullifyCurrentInstruction endif

Exceptions:

None

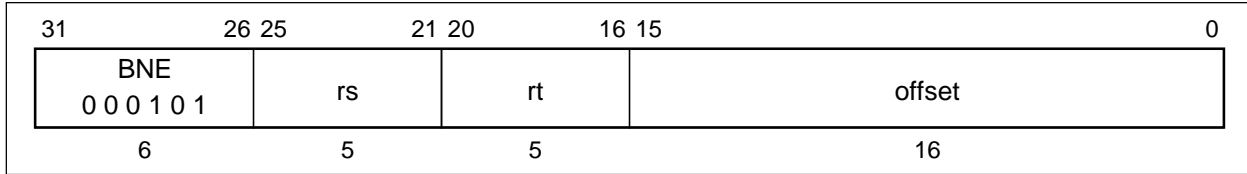
BNE**Branch on Not Equal****BNE****Format:**BNE *rs*, *rt*, *offset***Description:**

A branch target address is computed from the sum of the address of the instruction in the delay slot and the 16-bit *offset*, shifted left two bits and sign-extended. The contents of general register *rs* and the contents of general register *rt* are compared. If the two registers are not equal, then the program branches to the target address, with a delay of one instruction.

Operation:

32	T: $\text{target} \leftarrow (\text{offset}_{15})^{14} \parallel \text{offset} \parallel 0^2$ $\text{condition} \leftarrow (\text{GPR}[\text{rs}] \neq \text{GPR}[\text{rt}])$ T+1: if condition then PC \leftarrow PC + target endif
64	T: $\text{target} \leftarrow (\text{offset}_{15})^{46} \parallel \text{offset} \parallel 0^2$ $\text{condition} \leftarrow (\text{GPR}[\text{rs}] \neq \text{GPR}[\text{rt}])$ T+1: if condition then PC \leftarrow PC + target endif

Exceptions:

None

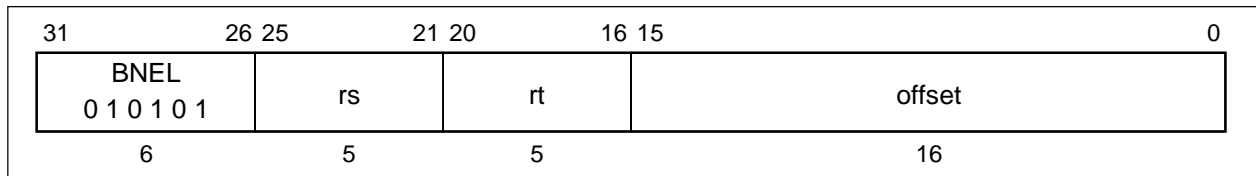
BNEL**Branch on Not Equal Likely****BNEL****Format:**

BNEL rs, rt, offset

Description:

A branch target address is computed from the sum of the address of the instruction in the delay slot and the 16-bit *offset*, shifted left two bits and sign-extended. The contents of general register *rs* and the contents of general register *rt* are compared. If the two registers are not equal, then the program branches to the target address, with a delay of one instruction.

If the conditional branch is not taken, the instruction in the branch delay slot is nullified.

Operation:

```

32   T:   target ← (offset15)14 || offset || 02
       condition ← (GPR [rs] ≠ GPR [rt])
       T+1: if condition then
           PC ← PC + target
       else
           NullifyCurrentInstruction
       endif

64   T:   target ← (offset15)46 || offset || 02
       condition ← (GPR [rs] ≠ GPR [rt])
       T+1: if condition then
           PC ← PC + target
       else
           NullifyCurrentInstruction
       endif

```

Exceptions:

None

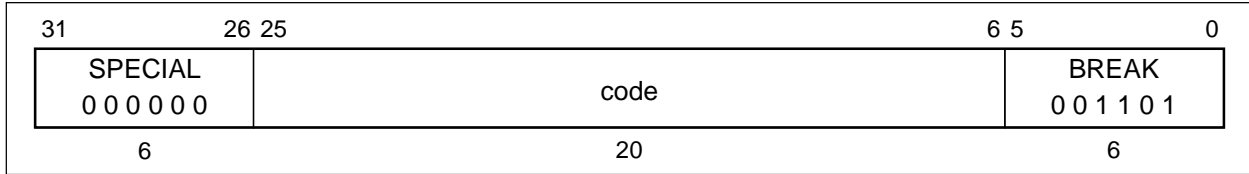
BREAK**Breakpoint****BREAK****Format:**

BREAK

Description:

A breakpoint trap occurs, immediately and unconditionally transferring control to the exception handler.

The code field is available for use as software parameters, but is retrieved by the exception handler only by loading the contents of the memory word containing the instruction.

Operation:

32, 64 T: BreakpointException

Exceptions:

Breakpoint exception

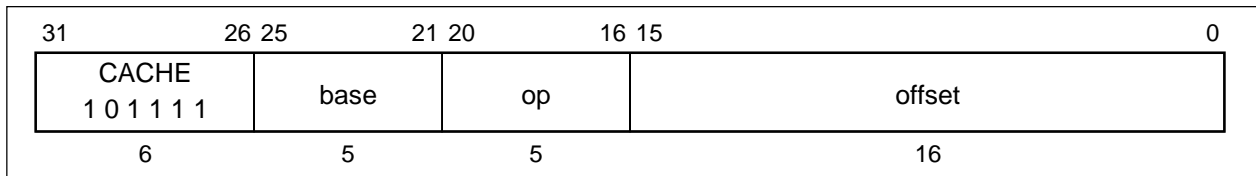
CACHE**Cache****CACHE****Format:**

CACHE op, offset (base)

Description:

The 16-bit *offset* is sign-extended and added to the contents of general register *base* to form a virtual address. The virtual address is translated to a physical address using the TLB, and the 5-bit sub-opcode specifies a cache operation for that address.

If CP0 is not usable (User or Supervisor mode) and the CP0 enable bit in the Status register is clear, a coprocessor unusable exception is taken. The operation of this instruction on any operation/cache combination not listed below, or on a secondary cache, is undefined. The operation of this instruction on uncached addresses is also undefined.

The Index operation uses part of the virtual address to specify a cache block.

For a primary cache of $2^{\text{CACHEBITS}}$ bytes with 2^{LINEBITS} bytes per tag, $\text{vAddr}_{\text{CACHEBITS} \dots \text{LINEBITS}}$ specifies the block.

Index_Load_Tag also uses $\text{vAddr}_{\text{LINEBITS} \dots 3}$ to select the doubleword for reading parity. When the *CE* bit of the Status register is set, Fill Cache op uses the PErr register to store parity values into the cache.

The Hit operation accesses the specified cache as normal data references, and performs the specified operation if the cache block contains valid data with the specified physical address (a hit). If the cache block is invalid or contains a different address (a miss), no operation is performed.

CACHE**Cache
(Continued)****CACHE**

Write back from a primary cache goes to memory. The address to be written is specified by the cache tag and not the translated physical address.

TLB Refill and TLB Invalid exceptions can occur on any operation. For Index operations (where the physical address is used to index the cache but need not match the cache tag) unmapped addresses may be used to avoid TLB exceptions. This operation never causes a TLB Modified exception.

Bits 17...16 of the instruction specify the cache as follows:

Code	Name	Cache
0	I	Instruction cache
1	D	Data cache
2	—	Reserved
3	—	Reserved

CACHE

Cache
(Continued)

CACHE

Bits 20...18 (this value is listed under the **Code** column) of the instruction specify the operation as follows:

Code	Cache	Name	Operation
0	I	Index_Invalidate	Set the cache state of the cache block to Invalid.
0	D	Index_Write_Back_Invalidate	Examine the cache state and W bit of the primary data cache block at the index specified by the virtual address. If the state is not Invalid and the W bit is set, then write back the block to memory. The address to write is taken from the primary cache tag. Set cache state of primary cache block to Invalid.
1	I, D	Index_Load_Tag	Read the tag for the cache block at the specified index and place it into the TagLo CP0 registers, ignoring parity errors. Also load the data parity bits into the ECC register.
2	I, D	Index_Store_Tag	Write the tag for the cache block at the specified index from the TagLo and TagHi CP0 registers.
3	D	Create_Dirty_Exclusive	This operation is used to avoid loading data needlessly from memory when writing new contents into an entire cache block. If the cache block does not contain the specified address, and the block is dirty, write it back to the memory. In all cases, set the cache state to Dirty.
4	I, D	Hit_Invalidate	If the cache block contains the specified address, mark the cache block invalid.
5	D	Hit_Write_Back_Invalidate	If the cache block contains the specified address, write back the data if it is dirty, and mark the cache block invalid.
5	I	Fill	Fill the primary instruction cache block from memory. If the CE bit of the Status register is set, the contents of the ECC register is used instead of the computed parity bits for addressed doubleword when written to the instruction cache.
6	D	Hit_Write_Back	If the cache block contains the specified address, and the W bit is set, write back the data to memory and clear the W bit.
6	I	Hit_Write_Back	If the cache block contains the specified address, write back the data unconditionally.

CACHE**Cache
(Continued)****CACHE****Operation:**

32, 64 T: $vAddr \leftarrow ((offset_{15})^{48} \parallel offset_{15...0}) + GPR [base]$ $(pAddr, uncached) \leftarrow AddressTranslation (vAddr, DATA)$ CacheOp (op, pAddr, vAddr)

Exceptions:

- Coprocessor unusable exception
- TLB refill exception
- TLB invalid exception
- Bus error exception
- Address error exception
- Cache error exception

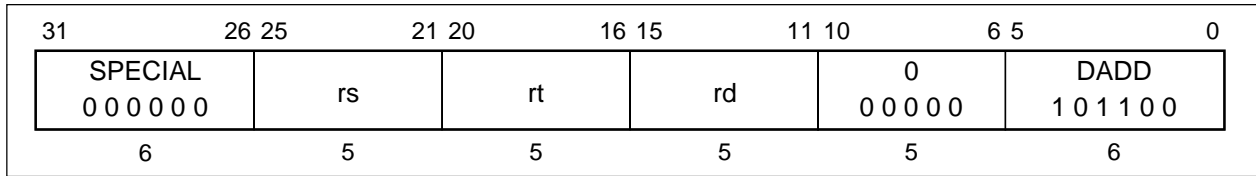
DADD**Doubleword Add****DADD****Format:**

DADD rd, rs, rt

Description:

The contents of general register *rs* and the contents of general register *rt* are added to form the result. The result is placed into general register *rd*.

An overflow exception occurs if the carries out of bits 62 and 63 differ (2's complement overflow). The destination register *rd* is not modified when an integer overflow exception occurs.

This operation is defined for the Vr4181 operating in 64-bit mode or in 32-bit kernel mode. Execution of this instruction in 32-bit user or supervisor mode causes a reserved instruction exception.

Operation:

64 T: GPR [rd] ← GPR [rs] + GPR [rt]
--

Exceptions:

Integer overflow exception

Reserved instruction exception (Vr4181 in 32-bit user mode, Vr4181 in 32-bit supervisor mode)

DADDI Doubleword Add Immediate DADDI

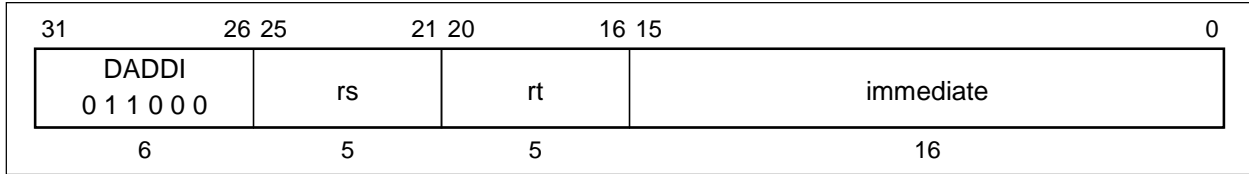
**Format:**

DADDI *rt*, *rs*, *immediate*

Description:

The 16-bit *immediate* is sign-extended and added to the contents of general register *rs* to form the result. The result is placed into general register *rt*.

An overflow exception occurs if carries out of bits 62 and 63 differ (2's complement overflow). The destination register *rt* is not modified when an integer overflow exception occurs.

This operation is defined for the VR4181 operating in 64-bit mode or in 32-bit kernel mode. Execution of this instruction in 32-bit user or supervisor mode causes a reserved instruction exception.

Operation:

64 T: $\text{GPR}[\text{rt}] \leftarrow \text{GPR}[\text{rs}] + (\text{immediate}_{15})^{48} \parallel \text{immediate}_{15..0}$

Exceptions:

Integer overflow exception

Reserved instruction exception (VR4181 in 32-bit user mode, VR4181 in 32-bit supervisor mode)

DADDIU Doubleword Add Immediate Unsigned DADDIU

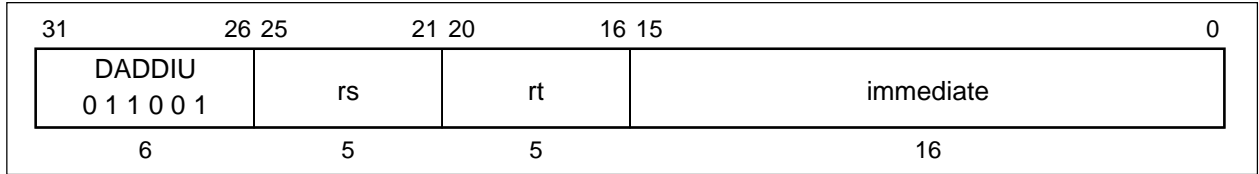
**Format:**

DADDIU rt, rs, immediate

Description:

The 16-bit *immediate* is sign-extended and added to the contents of general register *rs* to form the result. The result is placed into general register *rt*. No integer overflow exception occurs under any circumstances.

The only difference between this instruction and the DADDI instruction is that DADDIU never causes an overflow exception.

This operation is defined for the Vr4181 operating in 64-bit mode or in 32-bit kernel mode. Execution of this instruction in 32-bit user or supervisor mode causes a reserved instruction exception.

Operation:

64 T: $\text{GPR [rt]} \leftarrow \text{GPR [rs]} + (\text{immediate}_{15})^{48} \parallel \text{immediate}_{15\dots 0}$

Exceptions:

Reserved instruction exception (Vr4181 in 32-bit user mode, Vr4181 in 32-bit supervisor mode)

DADDU Doubleword Add Unsigned DADDU

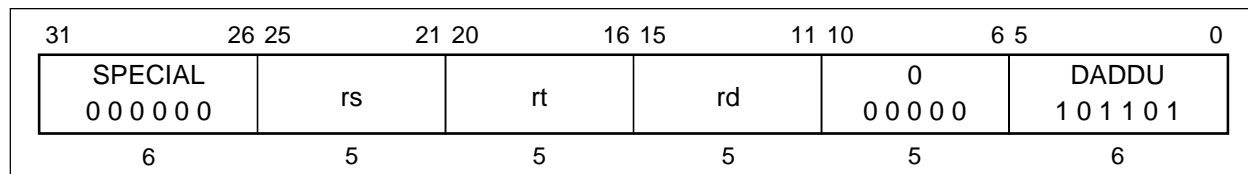
**Format:**

DADDU rd, rs, rt

Description:

The contents of general register *rs* and the contents of general register *rt* are added to form the result. The result is placed into general register *rd*.

No overflow exception occurs under any circumstances.

The only difference between this instruction and the DADD instruction is that DADDU never causes an overflow exception.

This operation is defined for the VR4181 operating in 64-bit mode or in 32-bit kernel mode. Execution of this instruction in 32-bit user or supervisor mode causes a reserved instruction exception.

Operation:

64	T: GPR [rd] ← GPR [rs] + GPR [rt]
----	-----------------------------------

Exceptions:

Reserved instruction exception (VR4181 in 32-bit user mode, VR4181 in 32-bit supervisor mode)

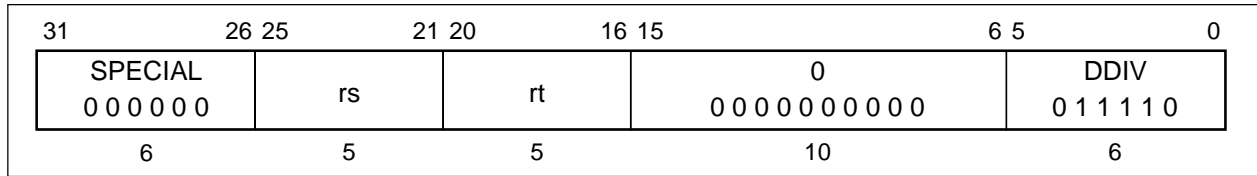
DDIV**Doubleword Divide****DDIV****Format:**

DDIV rs, rt

Description:

The contents of general register *rs* are divided by the contents of general register *rt*, treating both operands as 2's complement values. No overflow exception occurs under any circumstances, and the result of this operation is undefined when the divisor is zero.

This instruction is typically followed by additional instructions to check for a zero divisor and for overflow.

When the operation completes, the quotient word of the double result is loaded into special register *LO*, and the remainder word of the double result is loaded into special register *HI*.

If either of the two preceding instructions is MFHI or MFLO, the results of those instructions are undefined. Correct operation requires separating reads of *HI* or *LO* from writes by two or more instructions.

This operation is defined for the V_R4181 operating in 64-bit mode or in 32-bit kernel mode. Execution of this instruction in 32-bit user or supervisor mode causes a reserved instruction exception.

Operation:

64	T-2: LO ← undefined
	HI ← undefined
	T-1: LO ← undefined
	HI ← undefined
	T: LO ← GPR [rs] div GPR [rt]
	HI ← GPR [rs] mod GPR [rt]

Exceptions:

Reserved instruction exception (V_R4181 in 32-bit user mode, V_R4181 in 32-bit supervisor mode)

DDIVU Doubleword Divide Unsigned DDIVU

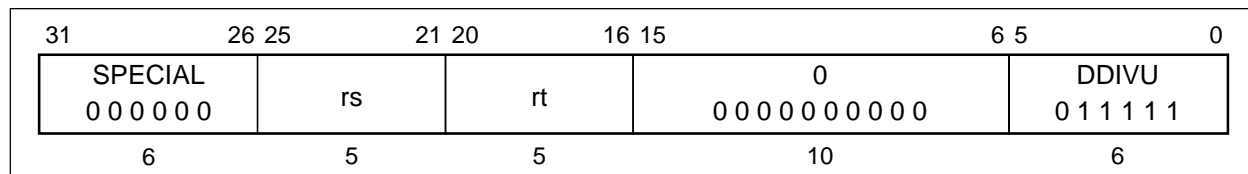
**Format:**

DDIVU rs, rt

Description:

The contents of general register *rs* are divided by the contents of general register *rt*, treating both operands as unsigned values. No integer overflow exception occurs under any circumstances, and the result of this operation is undefined when the divisor is zero.

This instruction may be followed by additional instructions to check for a zero divisor, inserted by the programmer.

When the operation completes, the quotient word of the double result is loaded into special register *LO*, and the remainder word of the double result is loaded into special register *HI*.

If either of the two preceding instructions is MFHI or MFLO, the results of those instructions are undefined. Correct operation requires separating reads of *HI* or *LO* from writes by two or more instructions.

This operation is defined for the Vr4181 operating in 64-bit mode or in 32-bit kernel mode. Execution of this instruction in 32-bit user or supervisor mode causes a reserved instruction exception.

Operation:

64	T-2: LO ← undefined
	HI ← undefined
	T-1: LO ← undefined
	HI ← undefined
	T: LO ← (0 GPR [rs]) div (0 GPR [rt])
	HI ← (0 GPR [rs]) mod (0 GPR [rt])

Exceptions:

Reserved instruction exception (Vr4181 in 32-bit user mode, Vr4181 in 32-bit supervisor mode)

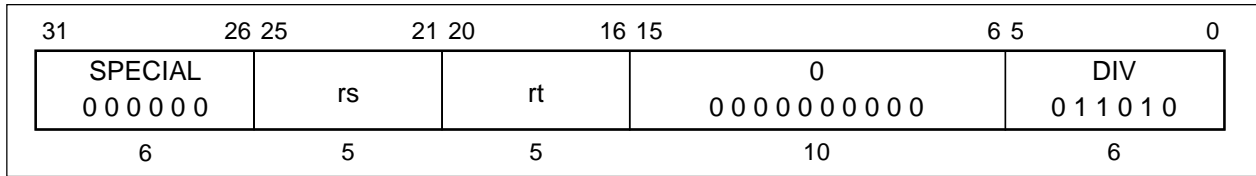
DIV**Divide****DIV****Format:**

DIV rs, rt

Description:

The contents of general register *rs* are divided by the contents of general register *rt*, treating both operands as 2's complement values. No overflow exception occurs under any circumstances, and the result of this operation is undefined when the divisor is zero.

In 64-bit mode, the operands must be valid sign-extended, 32-bit values.

This instruction is typically followed by additional instructions to check for a zero divisor and for overflow.

When the operation completes, the quotient word of the double result is loaded into special register *LO*, and the remainder word of the double result is loaded into special register *HI*.

If either of the two preceding instructions is *MFHI* or *MFLO*, the results of those instructions are undefined. Correct operation requires separating reads of *HI* or *LO* from writes by two or more instructions.

Operation:

32	T-2: LO ← undefined HI ← undefined T-1: LO ← undefined HI ← undefined T: LO ← GPR [rs] div GPR [rt] HI ← GPR [rs] mod GPR [rt]
64	T-2: LO ← undefined HI ← undefined T-1: LO ← undefined HI ← undefined T: q ← GPR [rs] _{31...0} div GPR [rt] _{31...0} r ← GPR [rs] _{31...0} mod GPR [rt] _{31...0} LO ← (q ₃₁) ³² q _{31...0} HI ← (r ₃₁) ³² r _{31...0}

Exceptions:

None

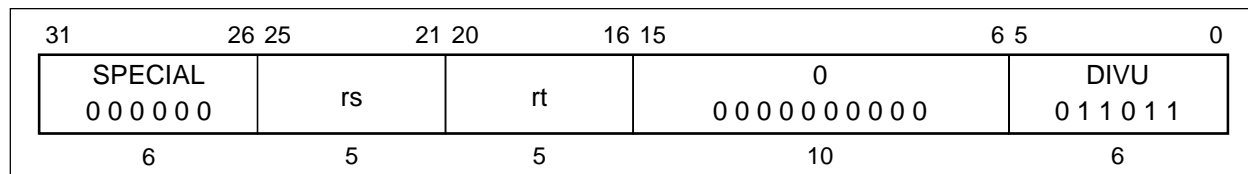
DIVU**Divide Unsigned****DIVU****Format:**

DIVU rs, rt

Description:

The contents of general register *rs* are divided by the contents of general register *rt*, treating both operands as unsigned values. No integer overflow exception occurs under any circumstances, and the result of this operation is undefined when the divisor is zero.

In 64-bit mode, the operands must be valid sign-extended, 32-bit values.

This instruction is typically followed by additional instructions to check for a zero divisor.

When the operation completes, the quotient word of the double result is loaded into special register *LO*, and the remainder word of the double result is loaded into special register *HI*.

If either of the two preceding instructions is MFHI or MFLO, the results of those instructions are undefined. Correct operation requires separating reads of *HI* or *LO* from writes by two or more instructions.

Operation:

32	T-2: LO ← undefined HI ← undefined
	T-1: LO ← undefined HI ← undefined
	T: LO ← (0 GPR [rs]) div (0 GPR [rt]) HI ← (0 GPR [rs]) mod (0 GPR [rt])
64	T-2: LO ← undefined HI ← undefined
	T-1: LO ← undefined HI ← undefined
	T: q ← (0 GPR [rs] _{31...0}) div (0 GPR [rt] _{31...0}) r ← (0 GPR [rs] _{31...0}) mod (0 GPR [rt] _{31...0}) LO ← (q ₃₁) ³² q _{31...0} HI ← (r ₃₁) ³² r _{31...0}

Exceptions:

None

DMADD16 Doubleword Multiply and Add 16-bit Integer DMADD16

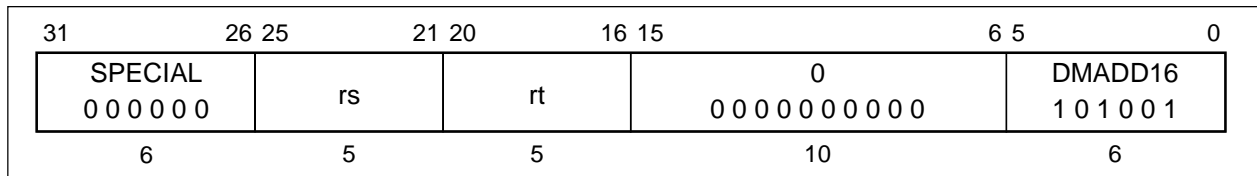
**Format:**

DMADD16 rs, rt

Description:

The contents of general registers *rs* and *rt* are multiplied, treating both operands as 16-bit 2's complement values. The operand[62:15] must be valid 15-bit, sign-extended values. If not, the result is unpredictable.

This multiplied result and the 64-bit data joined of special register *LO* is added to form the result as a signed integer. When the operation completes, the doubleword result is loaded into special register *LO*.

No integer overflow exception occurs under any circumstances.

This operation is defined for the Vr4181 operating in 64-bit mode or in 32-bit kernel mode. Execution of this instruction in 32-bit user or supervisor mode causes a reserved instruction exception.

The following table shows hazard cycles between DMADD16 and other instructions.

Instruction sequence	No. of cycles
MULT/MULTU → DMADD16	1 Cycle
DMULT/DMULTU → DMADD16	4 Cycles
DIV/DIVU → DMADD16	36 Cycles
DDIV/DDIVU → DMADD16	68 Cycles
MFHI/MFLO → DMADD16	2 Cycles
MADD16 → DMADD16	0 Cycles
DMADD16 → DMADD16	0 Cycles

DMADD16 Doubleword Multiply and Add 16-bit Integer DMADD16 (Continued)

Operation:

64	T-2: LO ← undefined
	HI ← undefined
	T-1: LO ← undefined
	HI ← undefined
	T: temp ← GPR [rs] * GPR [rt]
	temp ← temp + LO
	LO ← temp
	HI ← undefined

Exceptions:

Reserved instruction exception (V_R4181 in 32-bit user mode, V_R4181 in 32-bit supervisor mode)

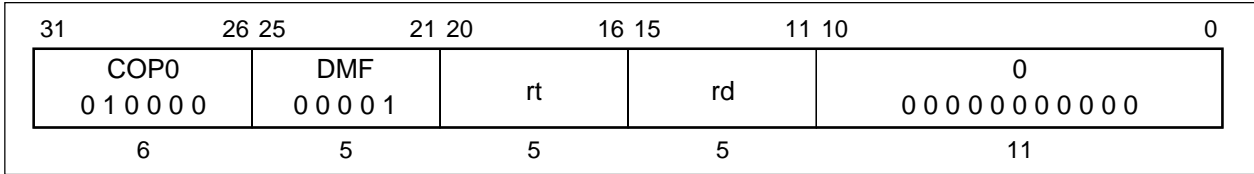
DMFC0 Doubleword Move from System Control Coprocessor DMFC0**Format:**

DMFC0 rt, rd

Description:

The contents of coprocessor register *rd* of the CP0 are loaded into general register *rt*.

This operation is defined for the Vr4181 operating in 64-bit mode or in 32-bit kernel mode. Execution of this instruction in 32-bit user or supervisor mode causes a reserved instruction exception. All 64-bits of the general register destination are written from the coprocessor register source. The operation of DMFC0 on a 32-bit coprocessor 0 register is undefined.

Operation:

64 T: data ← CPR [0, rd]
 T+1: GPR [rt] ← data

Exceptions:

Coprocessor unusable exception (user mode and supervisor mode if CP0 not enabled)

Reserved instruction exception (Vr4181 in 32-bit user mode, Vr4181 in 32-bit supervisor mode)

DMTC0 Doubleword Move to System Control Coprocessor DMTC0

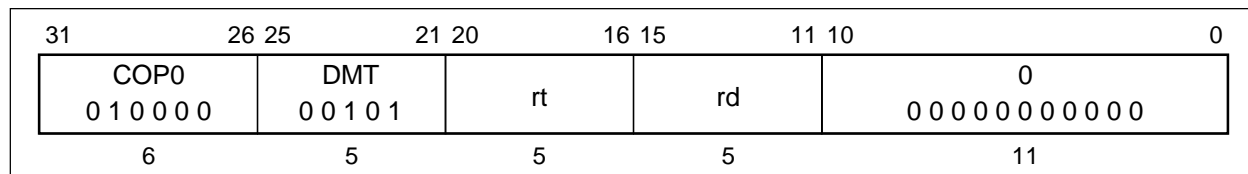
**Format:**DMTC0 *rt*, *rd***Description:**

The contents of general register *rt* are loaded into coprocessor register *rd* of the CP0.

This operation is defined for the VR4181 operating in 64-bit mode or in 32-bit kernel mode. Execution of this instruction in 32-bit user or supervisor mode causes a reserved instruction exception.

All 64-bits of the coprocessor 0 register are written from the general register source. The operation of DMTC0 on a 32-bit coprocessor 0 register is undefined.

Because the state of the virtual address translation system may be altered by this instruction, the operation of load instructions, store instructions, and TLB operations immediately prior to and after this instruction are undefined.

Operation:

64 T: data ← GPR [*rt*]
 T+1: CPR [0, *rd*] ← data

Exceptions:

Coprocessor unusable exception (In user and supervisor mode if CP0 not enabled)

Reserved instruction exception (VR4181 in 32-bit user mode, VR4181 in 32-bit supervisor mode)

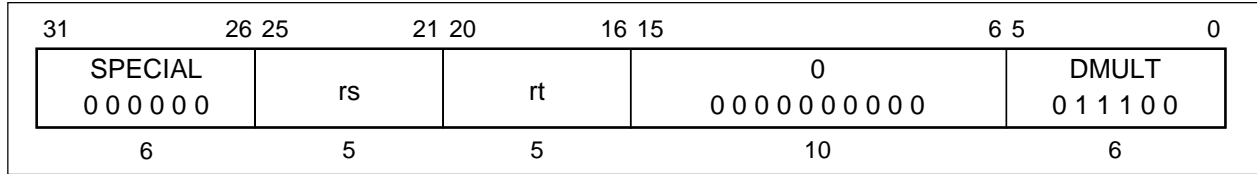
DMULT**Doubleword Multiply****DMULT****Format:**

DMULT rs, rt

Description:

The contents of general registers *rs* and *rt* are multiplied, treating both operands as 2's complement values. No integer overflow exception occurs under any circumstances.

When the operation completes, the low-order word of the double result is loaded into special register *LO*, and the high-order word of the double result is loaded into special register *HI*.

If either of the two preceding instructions is MFHI or MFLO, the results of these instructions are undefined. Correct operation requires separating reads of *HI* or *LO* from writes by a minimum of two other instructions.

This operation is defined for the V_R4181 operating in 64-bit mode or in 32-bit kernel mode. Execution of this instruction in 32-bit user or supervisor mode causes a reserved instruction exception.

Operation:

64	T-2: LO ← undefined HI ← undefined
	T-1: LO ← undefined HI ← undefined
T:	t ← GPR [rs] * GPR [rt] LO ← t _{63...0} HI ← t _{127...64}

Exceptions:

Reserved instruction exception (V_R4181 in 32-bit user mode, V_R4181 in 32-bit supervisor mode)

DMULTU Doubleword Multiply Unsigned DMULTU

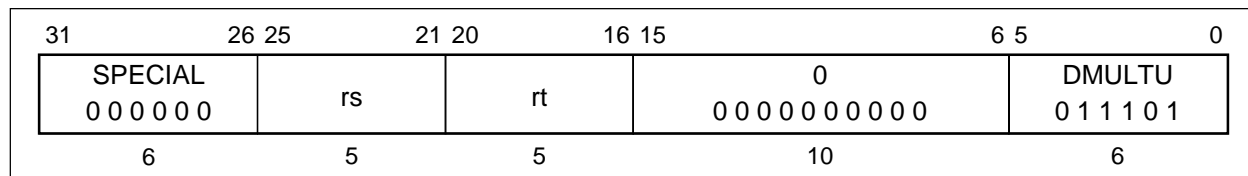
**Format:**

DMULTU rs, rt

Description:

The contents of general register *rs* and the contents of general register *rt* are multiplied, treating both operands as unsigned values. No overflow exception occurs under any circumstances.

When the operation completes, the low-order word of the double result is loaded into special register *LO*, and the high-order word of the double result is loaded into special register *HI*.

If either of the two preceding instructions is MFHI or MFLO, the results of these instructions are undefined. Correct operation requires separating reads of *HI* or *LO* from writes by a minimum of two instructions.

This operation is defined for the VR4181 operating in 64-bit mode or in 32-bit kernel mode. Execution of this instruction in 32-bit user or supervisor mode causes a reserved instruction exception.

Operation:

```

64   T-2: LO ← undefined
      HI  ← undefined
      T-1: LO ← undefined
      HI  ← undefined
      T:  t  ← (0 || GPR [rs]) * (0 || GPR [rt])
      LO  ← t63...0
      HI  ← t127...64

```

Exceptions:

Reserved instruction exception (VR4181 in 32-bit user mode, VR4181 in 32-bit supervisor mode)

DSLL Doubleword Shift Left Logical DSLL

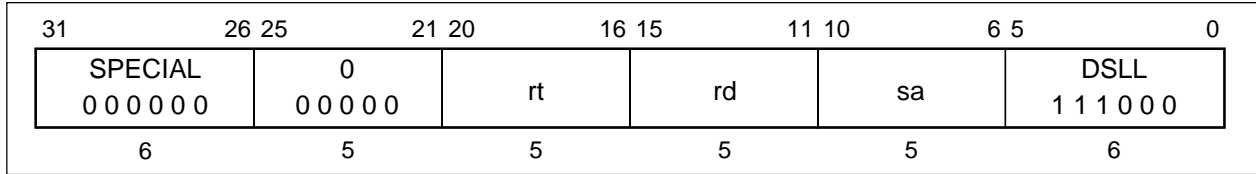
**Format:**

DSLL rd, rt, sa

Description:

The contents of general register *rt* are shifted left by *sa* bits, inserting zeros into the low-order bits. The result is placed in register *rd*.

This operation is defined for the V_R4181 operating in 64-bit mode or in 32-bit kernel mode. Execution of this instruction in 32-bit user or supervisor mode causes a reserved instruction exception.

Operation:

64	T: $s \leftarrow 0 \parallel sa$ $GPR [rd] \leftarrow GPR [rt]_{(63-s) \dots 0} \parallel 0^s$
----	---

Exceptions:

Reserved instruction exception (V_R4181 in 32-bit user mode, V_R4181 in 32-bit supervisor mode)

DSLLV Doubleword Shift Left Logical Variable DSLLV

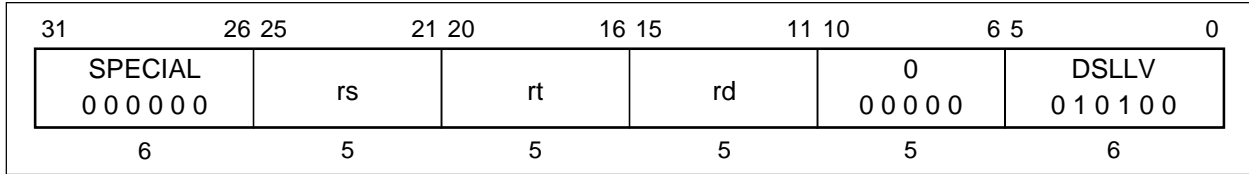
**Format:**

DSLLV rd, rt, rs

Description:

The contents of general register *rt* are shifted left by the number of bits specified by the low-order six bits contained in general register *rs*, inserting zeros into the low-order bits. The result is placed in register *rd*.

This operation is defined for the VR4181 operating in 64-bit mode or in 32-bit kernel mode. Execution of this instruction in 32-bit user or supervisor mode causes a reserved instruction exception.

Operation:

64 T: $s \leftarrow \text{GPR}[rs]_{5..0}$
 $\text{GPR}[rd] \leftarrow \text{GPR}[rt]_{(63-s)..0} \parallel 0^s$

Exceptions:

Reserved instruction exception (VR4181 in 32-bit user mode, VR4181 in 32-bit supervisor mode)

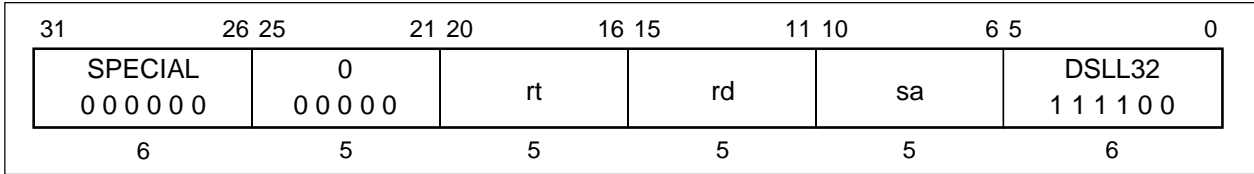
DSLL32**Doubleword Shift Left Logical + 32****DSLL32****Format:**

DSLL32 rd, rt, sa

Description:

The contents of general register *rt* are shifted left by $32 + sa$ bits, inserting zeros into the low-order bits. The result is placed in register *rd*.

This operation is defined for the Vr4181 operating in 64-bit mode or in 32-bit kernel mode. Execution of this instruction in 32-bit user or supervisor mode causes a reserved instruction exception.

Operation:

64 T: $s \leftarrow 1 \parallel sa$
 $GPR [rd] \leftarrow GPR [rt]_{(63-s) \dots 0} \parallel 0^s$

Exceptions:

Reserved instruction exception (Vr4181 in 32-bit user mode, Vr4181 in 32-bit supervisor mode)

DSRA Doubleword Shift Right Arithmetic DSRA

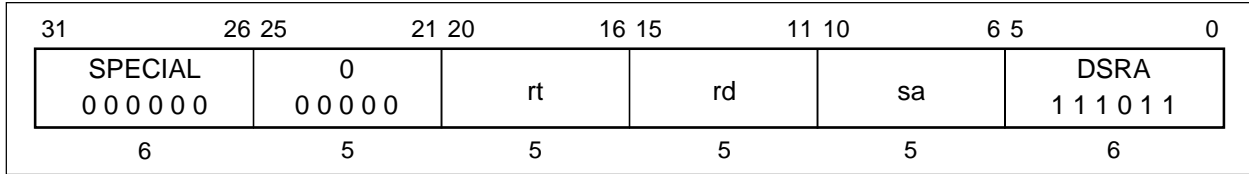
**Format:**

DSRA rd, rt, sa

Description:

The contents of general register *rt* are shifted right by *sa* bits, sign-extending the high-order bits. The result is placed in register *rd*.

This operation is defined for the VR4181 operating in 64-bit mode or in 32-bit kernel mode. Execution of this instruction in 32-bit user or supervisor mode causes a reserved instruction exception.

Operation:

64 T: $s \leftarrow 0 \parallel sa$
 $GPR [rd] \leftarrow (GPR [rt]_{63})^s \parallel GPR [rt]_{63..s}$

Exceptions:

Reserved instruction exception (VR4181 in 32-bit user mode, VR4181 in 32-bit supervisor mode)

DSRAV Doubleword Shift Right Arithmetic Variable DSRVAV

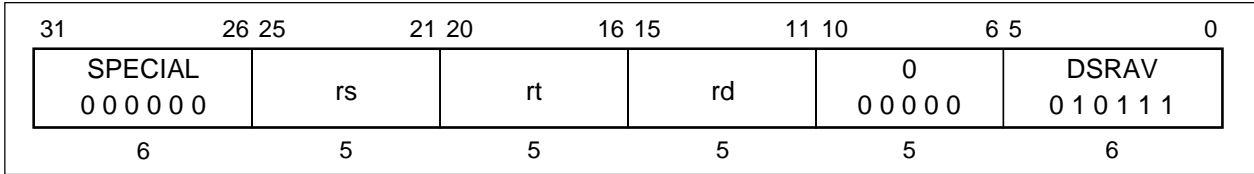
**Format:**

DSRAV rd, rt, rs

Description:

The contents of general register *rt* are shifted right by the number of bits specified by the low-order six bits of general register *rs*, sign-extending the high-order bits. The result is placed in register *rd*.

This operation is defined for the V_R4181 operating in 64-bit mode or in 32-bit kernel mode. Execution of this instruction in 32-bit user or supervisor mode causes a reserved instruction exception.

Operation:

64	T: $s \leftarrow \text{GPR}[rs]_{5..0}$ $\text{GPR}[rd] \leftarrow (\text{GPR}[rt]_{63})^s \parallel \text{GPR}[rt]_{63..s}$
----	---

Exceptions:

Reserved instruction exception (V_R4181 in 32-bit user mode, V_R4181 in 32-bit supervisor mode)

DSRA32 Doubleword Shift Right Arithmetic + 32 DSRA32

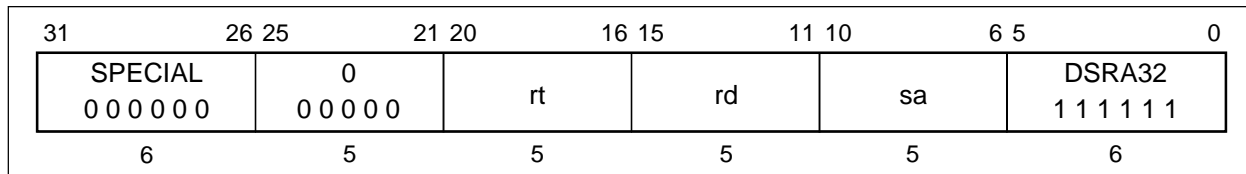
**Format:**

DSRA32 rd, rt, sa

Description:

The contents of general register *rt* are shifted right by $32 + sa$ bits, sign-extending the high-order bits. The result is placed in register *rd*.

This operation is defined for the VR4181 operating in 64-bit mode or in 32-bit kernel mode. Execution of this instruction in 32-bit user or supervisor mode causes a reserved instruction exception.

Operation:

64 T: $s \leftarrow 1 \parallel sa$
 $GPR [rd] \leftarrow (GPR [rt]_{63})^s \parallel GPR [rt]_{63...s}$

Exceptions:

Reserved instruction exception (VR4181 in 32-bit user mode, VR4181 in 32-bit supervisor mode)

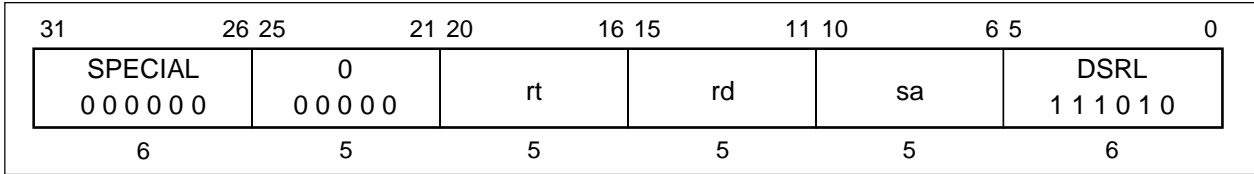
DSRL**Doubleword Shift Right Logical****DSRL****Format:**

DSRL rd, rt, sa

Description:

The contents of general register *rt* are shifted right by *sa* bits, inserting zeros into the high-order bits. The result is placed in register *rd*.

This operation is defined for the V_R4181 operating in 64-bit mode or in 32-bit kernel mode. Execution of this instruction in 32-bit user or supervisor mode causes a reserved instruction exception.

Operation:

64	T: $s \leftarrow 0 \parallel sa$ $GPR [rd] \leftarrow 0^s \parallel GPR [rt]_{63..s}$
----	--

Exceptions:

Reserved instruction exception (V_R4181 in 32-bit user mode, V_R4181 in 32-bit supervisor mode)

DSRLV Doubleword Shift Right Logical Variable DSRLV

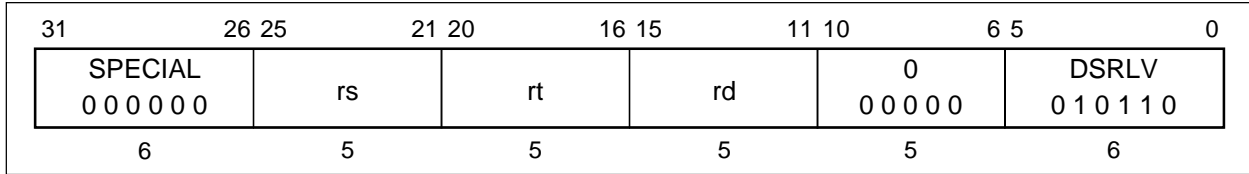
**Format:**

DSRLV rd, rt, rs

Description:

The contents of general register *rt* are shifted right by the number of bits specified by the low-order six bits of general register *rs*, inserting zeros into the high-order bits. The result is placed in register *rd*.

This operation is defined for the VR4181 operating in 64-bit mode or in 32-bit kernel mode. Execution of this instruction in 32-bit user or supervisor mode causes a reserved instruction exception.

Operation:

64 T: $s \leftarrow \text{GPR}[rs]_{5..0}$
 $\text{GPR}[rd] \leftarrow 0^s \parallel \text{GPR}[rt]_{63..s}$

Exceptions:

Reserved instruction exception (VR4181 in 32-bit user mode, VR4181 in 32-bit supervisor mode)

DSRL32 Doubleword Shift Right Logical + 32 DSRL32

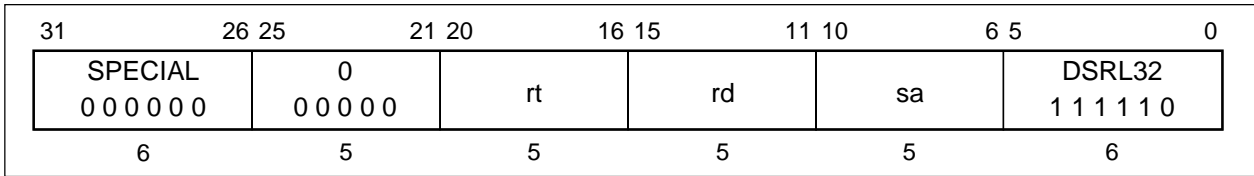
**Format:**

DSRL32 rd, rt, sa

Description:

The contents of general register *rt* are shifted right by $32 + sa$ bits, inserting zeros into the high-order bits. The result is placed in register *rd*.

This operation is defined for the V_R4181 operating in 64-bit mode or in 32-bit kernel mode. Execution of this instruction in 32-bit user or supervisor mode causes a reserved instruction exception.

Operation:

64	T: $s \leftarrow 1 \parallel sa$ $GPR [rd] \leftarrow 0^s \parallel GPR [rt]_{63..s}$
----	--

Exceptions:

Reserved instruction exception (V_R4181 in 32-bit user mode, V_R4181 in 32-bit supervisor mode)

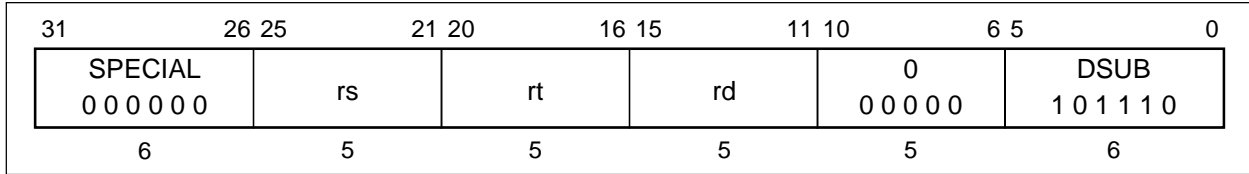
DSUB**Doubleword Subtract****DSUB****Format:**

DSUB rd, rs, rt

Description:

The contents of general register *rt* are subtracted from the contents of general register *rs* to form a result. The result is placed into general register *rd*.

The only difference between this instruction and the DSUBU instruction is that DSUBU never traps on overflow.

An integer overflow exception takes place if the carries out of bits 62 and 63 differ (2's complement overflow).

The destination register *rd* is not modified when an integer overflow exception occurs.

This operation is defined for the VR4181 operating in 64-bit mode or in 32-bit kernel mode. Execution of this instruction in 32-bit user or supervisor mode causes a reserved instruction exception.

Operation:

64	T: GPR [rd] ← GPR [rs] – GPR [rt]
----	-----------------------------------

Exceptions:

Integer overflow exception

Reserved instruction exception (VR4181 in 32-bit user mode, VR4181 in 32-bit supervisor mode)

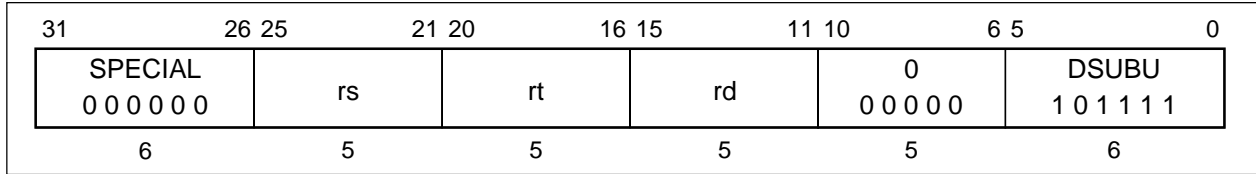
DSUBU**Doubleword Subtract Unsigned****DSUBU****Format:**

DSUBU rd, rs, rt

Description:

The contents of general register *rt* are subtracted from the contents of general register *rs* to form a result. The result is placed into general register *rd*.

The only difference between this instruction and the DSUB instruction is that DSUBU never traps on overflow. No integer overflow exception occurs under any circumstances.

This operation is defined for the Vr4181 operating in 64-bit mode or in 32-bit kernel mode. Execution of this instruction in 32-bit user or supervisor mode causes a reserved instruction exception.

Operation:

64 T: GPR [rd] ← GPR [rs] – GPR [rt]
--

Exceptions:

Reserved instruction exception (Vr4181 in 32-bit user mode, Vr4181 in 32-bit supervisor mode)

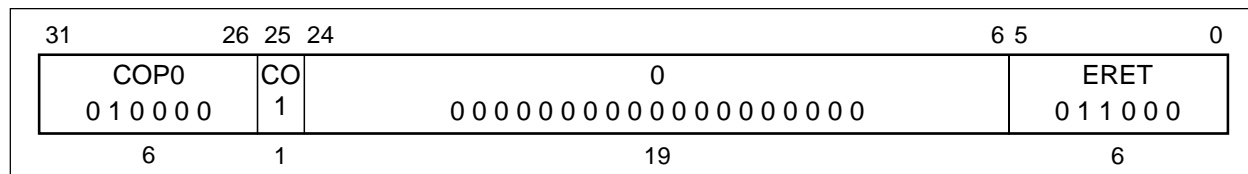
ERET**Exception Return****ERET****Format:**

ERET

Description:

ERET is the Vr4181 instruction for returning from an interrupt, exception, or error trap. Unlike a branch or jump instruction, ERET does not execute the next instruction.

ERET must not itself be placed in a branch delay slot.

If the processor is servicing an error trap ($SR_2 = 1$), then load the PC from the ErrorEPC register and clear the *ERL* bit of the Status register (SR_2). Otherwise ($SR_2 = 0$), load the PC from the EPC register, and clear the *EXL* bit of the Status register ($SR_1 = 0$).

When a MIPS16 instruction can be executed, the value of clearing the least significant bit of the EPC or error EPC register to 0 is loaded to PC. This means the content of the least significant bit is reflected on the ISA mode bit (internal).

Operation:

```

32, 64 T:  if SR2 = 1 then
            if MIPS16EN = 1 then
                PC ← ErrorEPC63...1 || 0
                ISA MODE ← ErrorEPC0
            else
                PC ← ErrorEPC
            endif
            SR ← SR31...3 || 0 || SR1...0
        else
            if MIPS16EN = 1 then
                PC ← EPC63...1 || 0
                ISA MODE ← EPC0
            else
                PC ← EPC
            endif
            SR ← SR31...2 || 0 || SR0
        endif

```

Exceptions:

Coprocessor unusable exception

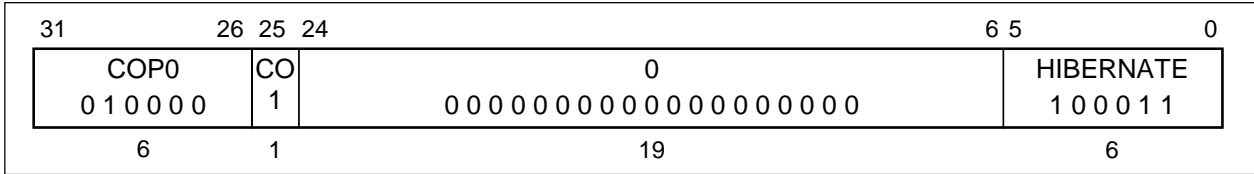
HIBERNATE**Hibernate****HIBERNATE****Format:**

HIBERNATE

Description:

HIBERNATE instruction starts mode transition from Fullspeed mode to Hibernate mode.

When the HIBERNATE instruction finishes the WB stage, the VR4181 wait by the SysAD bus is idle state, after then the internal clocks and the system interface clocks will shut down, thus freezing the pipeline.

Once the VR4181 is in Hibernate mode, the Cold Reset sequence will cause the VR4181 to exit Hibernate mode and to enter Fullspeed mode.

Operation:

32, 64 T:
T+1: Hibernate operation ()

Exceptions:

Coprocessor unusable exception

Remark Refer to Chapter 16 for details about the operation of the peripheral units at mode transition.

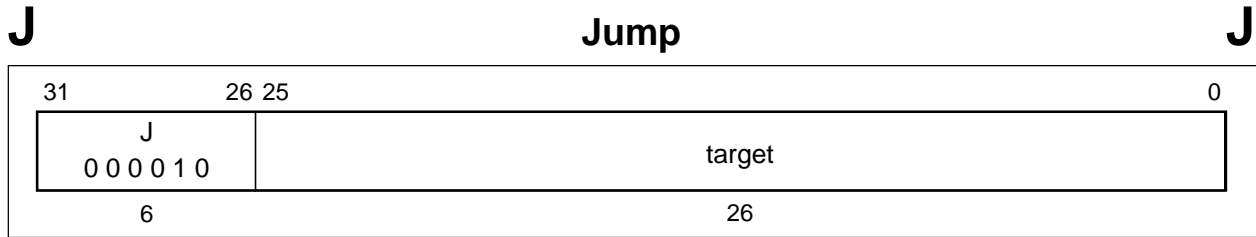
**Format:**

J target

Description:

The 26-bit target address is shifted left two bits and combined with the high-order four bits of the address of the delay slot. The program unconditionally jumps to this calculated address with a delay of one instruction.

Operation:

32	T: temp ← target T+1: PC ← PC _{31...28} temp 0 ²
64	T: temp ← target T+1: PC ← PC _{63...28} temp 0 ²

Exceptions:

None

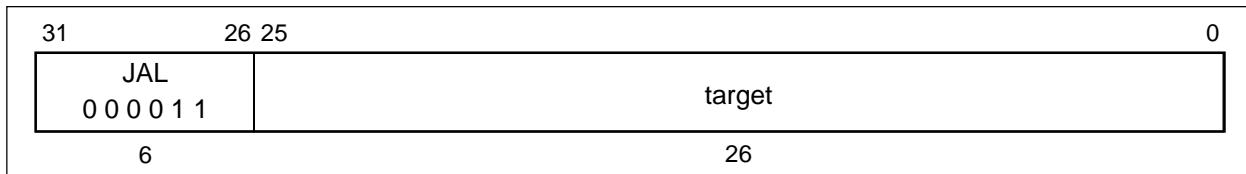
JAL**Jump And Link****JAL****Format:**

JAL target

Description:

The 26-bit target address is shifted left two bits and combined with the high-order four bits of the address of the delay slot. The program unconditionally jumps to this calculated address with a delay of one instruction. The address of the instruction after the delay slot is placed in the link register, *r31*. The address of the instruction immediately after a delay slot is placed in the link register (*r31*). When a MIPS16 instruction can be executed, the value of bit 0 of *r31* indicates the ISA mode bit before jump.

Operation:

```

32   T:  temp ← target
      if MIPS16EN = 1 then
          GPR [31] ← (PC + 8)31...1 || ISA MODE
      else
          GPR [31] ← PC + 8
      endif
      T+1: PC ← PC31...28 || temp || 02

64   T:  temp ← target
      if MIPS16EN = 1 then
          GPR [31] ← (PC + 8)63...1 || ISA MODE
      else
          GPR [31] ← PC + 8
      endif
      T+1: PC ← PC63...28 || temp || 02

```

Exceptions:

None

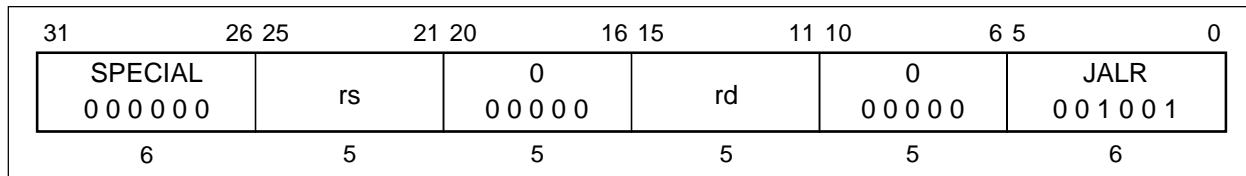
JALR**Jump And Link Register****JALR****Format:**

JALR rs
JALR rd, rs

Description:

The program unconditionally jumps to the address contained in general register *rs*, with a delay of one instruction.

When a MIPS16 instruction can be executed, the program unconditionally jumps with a delay of one instruction to the address indicated by the value of clearing the least significant bit of the general-purpose register *rs* to 0. Then, the content of the least significant bit of the general-purpose register *rs* is set to the ISA mode bit (internal). The address of the instruction after the delay slot is placed in general register *rd*. The default value of *rd*, if omitted in the assembly language instruction, is 31. When a MIPS16 instruction can be executed, the value of bit 0 of *rd* indicates the ISA mode bit before jump.

Register specifiers *rs* and *rd* may not be equal, because such an instruction does not have the same effect when re-executed. Because storing a link address destroys the contents of *rs* if they are equal. However, an attempt to execute this instruction is *not* trapped, and the result of executing such an instruction is undefined.

Since 32-bit length instructions must be word-aligned, a **Jump and Link Register (JALR)** instruction must specify a target register (*rs*) that contains an address whose two low-order bits are zero when a MIPS16 instruction can be executed. If these low-order bits are not zero, an address error exception will occur when the jump target instruction is subsequently fetched.

Operation:

```

32, 64 T: temp ← GPR [rs]
          if MIPS16EN = 1 then
              GPR [rd] ← (PC + 8)63...1 || ISA MODE
          else
              GPR [rd] ← PC + 8
          endif
T+1: if MIPS16EN = 1 then
      PC ← temp63...1 || 0
      ISA MODE ← temp
    else
      PC ← temp
    endif

```

Exceptions:

None

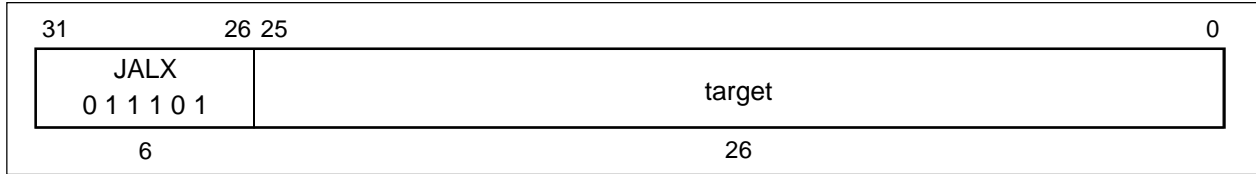
JALX**Jump And Link Exchange****JALX****Format:**

JALX target

Description:

When a MIPS16 instruction can be executed, a 26-bit target is shifted to left by 2 bits and then added to higher 4 bits of the delay slot's address to make a target address. The program unconditionally jumps to the target address with a delay of one instruction. The address of the instruction that follows the delay slot is stored to the link register (r31). The ISA mode bit is inverted with a delay of one instruction. The value of bit 0 of the link register (r31) indicates the ISA mode bit before jump.

Operation:

32	T: temp ← target GPR [31] ← (PC + 8) _{31...1} ISA MODE T+1: PC ← PC _{31...28} temp 0 ² ISA MODE toggle
64	T: temp ← target GPR [31] ← (PC + 8) _{63...1} ISA MODE T+1: PC ← PC _{63...28} temp 0 ² ISA MODE toggle

Exceptions:

Reserved instruction exception (when MIPS16 instruction execution disabled)

JR Jump Register JR

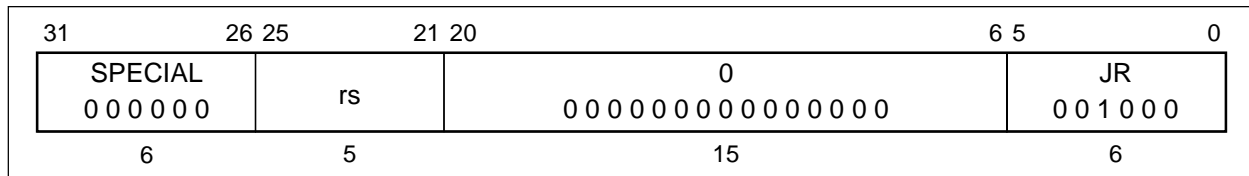
**Format:**

JR rs

Description:

The program unconditionally jumps to the address contained in general register *rs*, with a delay of one instruction.

When a MIPS16 instruction can be executed, the program unconditionally jumps with a delay of one instruction to the address indicated by the value of clearing the least significant bit of the general-purpose register *rs* to 0. Then, the content of the least significant bit of the general-purpose register *rs* is set to the ISA mode bit (internal). Since 32-bit length instructions must be word-aligned, a **Jump Register (JR)** instruction must specify a target register (*rs*) that contains an address whose two low-order bits are zero when a MIPS16 instruction can be executed. If these low-order bits are not zero, an address error exception will occur when the jump target instruction is subsequently fetched.

Operation:

```

32, 64 T: temp ← GPR [rs]
      T+1: if MIPS16EN = 1 then
            PC ← temp63...1 || 0
            ISA MODE ← temp0
      else
            PC ← temp
      endif

```

Exceptions:

None

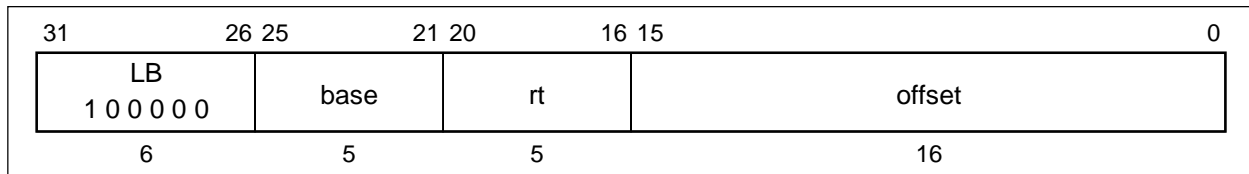
LB**Load Byte****LB****Format:**LB *rt*, *offset* (*base*)**Description:**

The 16-bit *offset* is sign-extended and added to the contents of general register *base* to form a virtual address. The contents of the byte at the memory location specified by the effective address are sign-extended and loaded into general register *rt*.

Operation:

32	<p>T: $vAddr \leftarrow ((offset_{15})^{16} \parallel offset_{15...0}) + GPR [base]$ $(pAddr, uncached) \leftarrow AddressTranslation (vAddr, DATA)$ $pAddr \leftarrow pAddr_{PSIZE-1...3} \parallel (pAddr_{2...0} \text{ xor } ReverseEndian^3)$ $mem \leftarrow LoadMemory (uncached, BYTE, pAddr, vAddr, DATA)$ $byte \leftarrow vAddr_{2...0} \text{ xor } BigEndianCPU^3$ $GPR [rt] \leftarrow (mem_{7+8*byte})^{24} \parallel mem_{7+8*byte...8*byte}$</p>
64	<p>T: $vAddr \leftarrow ((offset_{15})^{48} \parallel offset_{15...0}) + GPR [base]$ $(pAddr, uncached) \leftarrow AddressTranslation (vAddr, DATA)$ $pAddr \leftarrow pAddr_{PSIZE-1...3} \parallel (pAddr_{2...0} \text{ xor } ReverseEndian^3)$ $mem \leftarrow LoadMemory (uncached, BYTE, pAddr, vAddr, DATA)$ $byte \leftarrow vAddr_{2...0} \text{ xor } BigEndianCPU^3$ $GPR [rt] \leftarrow (mem_{7+8*byte})^{56} \parallel mem_{7+8*byte...8*byte}$</p>

Exceptions:

- TLB refill exception
- TLB invalid exception
- Bus error exception
- Address error exception

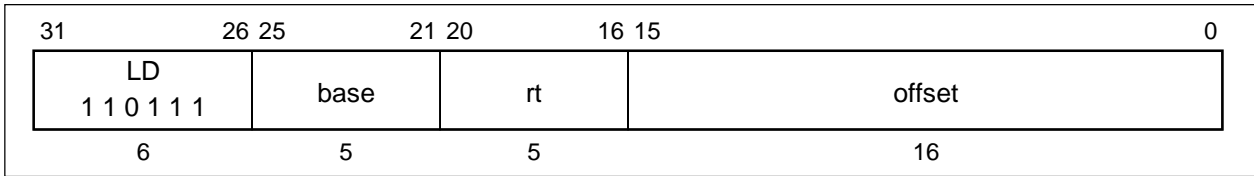
LD**Load Doubleword****LD****Format:**LD *rt*, *offset* (*base*)**Description:**

The 16-bit *offset* is sign-extended and added to the contents of general register *base* to form a virtual address. The contents of the 64-bit doubleword at the memory location specified by the effective address are loaded into general register *rt*.

If any of the three least-significant bits of the effective address are non-zero, an address error exception occurs.

This operation is defined for the VR4181 operating in 64-bit mode or in 32-bit kernel mode. Execution of this instruction in 32-bit user or supervisor mode causes a reserved instruction exception.

Operation:

```

64    T:  vAddr ← ((offset15)48 || offset15...0) + GPR [base]
        (pAddr, uncached) ← AddressTranslation (vAddr, DATA)
        data ← LoadMemory (uncached, DOUBLEWORD, pAddr, vAddr, DATA)
        GPR [rt] ← data

```

Exceptions:

TLB refill exception

TLB invalid exception

Bus error exception

Address error exception

Reserved instruction exception (VR4181 in 32-bit user mode, VR4181 in 32-bit supervisor mode)

LDL LDL

Load Doubleword Left

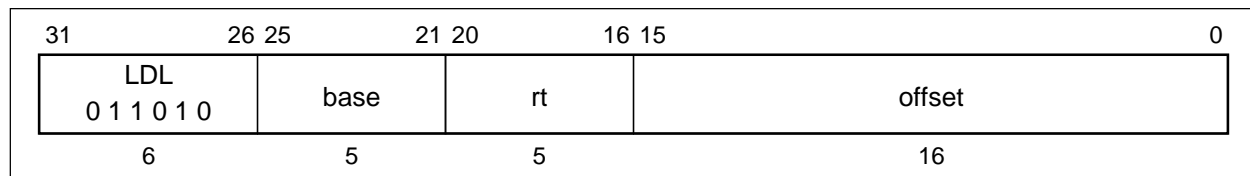

Format:

LDL rt, offset (base)

Description:

This instruction can be used in combination with the LDR instruction to load a register with eight consecutive bytes from memory, when the bytes cross a doubleword boundary. LDL loads the left portion of the register with the appropriate part of the high-order doubleword; LDR loads the right portion of the register with the appropriate part of the low-order doubleword.

The LDL instruction adds its sign-extended 16-bit *offset* to the contents of general register *base* to form a virtual address that can specify an arbitrary byte. It reads bytes only from the doubleword in memory that contains the specified starting byte. From one to eight bytes will be loaded, depending on the starting byte specified.

Conceptually, it starts at the specified byte in memory and loads that byte into the high-order (left-most) byte of the register; then it loads bytes from memory into the register until it reaches the low-order byte of the doubleword in memory. The least-significant (right-most) byte(s) of the register will not be changed.

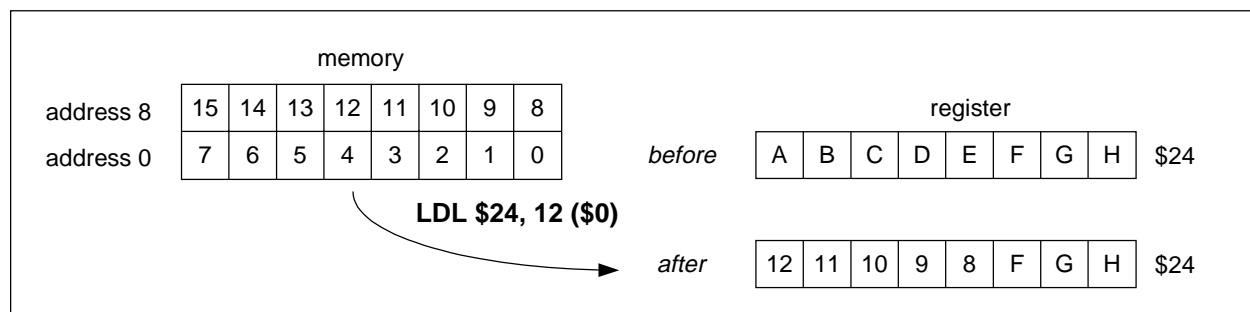

LDL**Load Doubleword Left
(Continued)****LDL**

The contents of general register *rt* are internally bypassed within the processor so that no NOP is needed between an immediately preceding load instruction which specifies register *rt* and a following LDL (or LDR) instruction which also specifies register *rt*.

No address error exceptions due to alignment are possible.

This operation is defined for the Vr4181 operating in 64-bit mode or in 32-bit kernel mode. Execution of this instruction in 32-bit user or supervisor mode causes a reserved instruction exception.

Operation:

```

64    T:  vAddr ← ((offset15)48 || offset15...0) + GPR [base]
        (pAddr, uncached) ← AddressTranslation (vAddr, DATA)
        pAddr ← pAddrPSIZE-1...3 || (pAddr2...0 xor ReverseEndian3)
        if BigEndianMem = 0 then
            pAddr ← pAddrPSIZE-1...3 || 03
        endif
        byte ← vAddr2...0 xor BigEndianCPU3
        mem ← LoadMemory (uncached, byte, pAddr, vAddr, DATA)
        GPR [rt] ← mem7+8*byte...0 || GPR [rt]55-8*byte...0

```

LDL

Load Doubleword Left (Continued)

LDL

Given a doubleword in a register and a doubleword in memory, the operation of LDL is as follows:

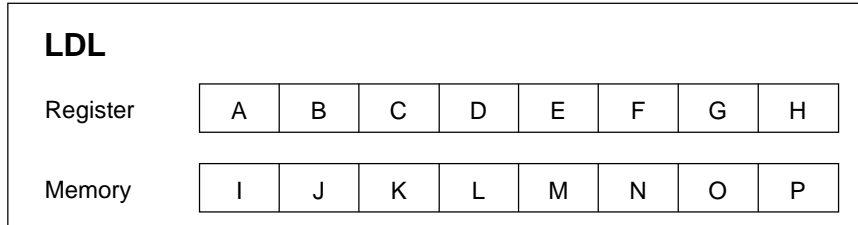

vAddr _{2,0}	BigEndianCPU = 0		
	destination	type	offset (LEM)
0	P B C D E F G H	0	0
1	O P C D E F G H	1	0
2	N O P D E F G H	2	0
3	M N O P E F G H	3	0
4	L M N O P F G H	4	0
5	K L M N O P G H	5	0
6	J K L M N O P H	6	0
7	I J K L M N O P	7	0

LEM Little-endian memory (BigEndianMem = 0)
Type AccessType (see **Figure 3-2**) sent to memory
Offset pAddr_{2,0} sent to memory

Exceptions:

- TLB refill exception
- TLB invalid exception
- Bus error exception
- Address error exception
- Reserved instruction exception (VR4181 in 32-bit user mode, VR4181 in 32-bit supervisor mode)

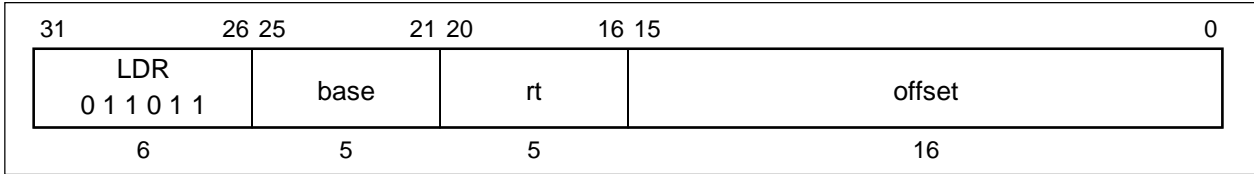
LDR**Load Doubleword Right****LDR****Format:**

LDR rt, offset (base)

Description:

This instruction can be used in combination with the LDL instruction to load a register with eight consecutive bytes from memory, when the bytes cross a doubleword boundary. LDR loads the right portion of the register with the appropriate part of the low-order doubleword; LDL loads the left portion of the register with the appropriate part of the high-order doubleword.

The LDR instruction adds its sign-extended 16-bit *offset* to the contents of general register *base* to form a virtual address that can specify an arbitrary byte. It reads bytes only from the doubleword in memory that contains the specified starting byte. From one to eight bytes will be loaded, depending on the starting byte specified.

Conceptually, it starts at the specified byte in memory and loads that byte into the low-order (right-most) byte of the register; then it loads bytes from memory into the register until it reaches the high-order byte of the doubleword in memory. The most significant (left-most) byte(s) of the register will not be changed.

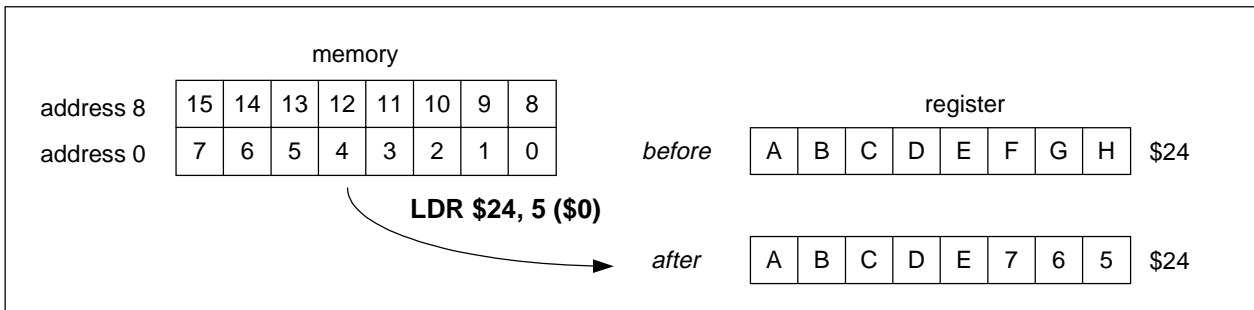

LDR**Load Doubleword Right
(Continued)****LDR**

The contents of general register *rt* are internally bypassed within the processor so that no NOP is needed between an immediately preceding load instruction which specifies register *rt* and a following LDR (or LDL) instruction which also specifies register *rt*.

No address error exceptions due to alignment are possible.

This operation is defined for the Vr4181 operating in 64-bit mode or in 32-bit kernel mode. Execution of this instruction in 32-bit user or supervisor mode causes a reserved instruction exception.

Operation:

```

64    T:  vAddr ← ((offset15)48 || offset15...0) + GPR [base]
        (pAddr, uncached) ← AddressTranslation (vAddr, DATA)
        pAddr ← pAddrPSIZE-1...3 || (pAddr2...0 xor ReverseEndian3)
        if BigEndianMem = 1 then
            pAddr ← pAddrPSIZE-1...3 || 03
        endif
        byte ← vAddr2...0 xor BigEndianCPU3
        mem ← LoadMemory (uncached, DOUBLEWORD-byte, pAddr, vAddr, DATA)
        GPR [rt] ← GPR [rt]63...64-8*byte || mem63...8*byte

```

LDR

Load Doubleword Right (Continued)

LDR

Given a doubleword in a register and a doubleword in memory, the operation of LDR is as follows:

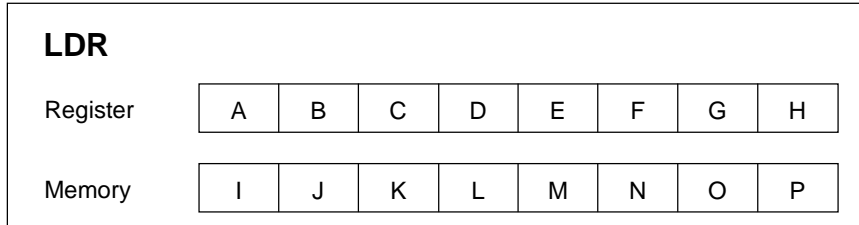

vAddr _{2,0}	BigEndianCPU = 0		
	destination	type	offset (LEM)
0	I J K L M N O P	7	0
1	A I J K L M N O	6	1
2	A B I J K L M N	5	2
3	A B C I J K L M	4	3
4	A B C D I J K L	3	4
5	A B C D E I J K	2	5
6	A B C D E F I J	1	6
7	A B C D E F G I	0	7

LEM Little-endian memory (BigEndianMem = 0)
Type AccessType (see **Figure 3-2**) sent to memory
Offset pAddr_{2,0} sent to memory

Exceptions:

- TLB refill exception
- TLB invalid exception
- Bus error exception
- Address error exception
- Reserved instruction exception (V_R4181 in 32-bit user mode, V_R4181 in 32-bit supervisor mode)

LH Load Halfword LH

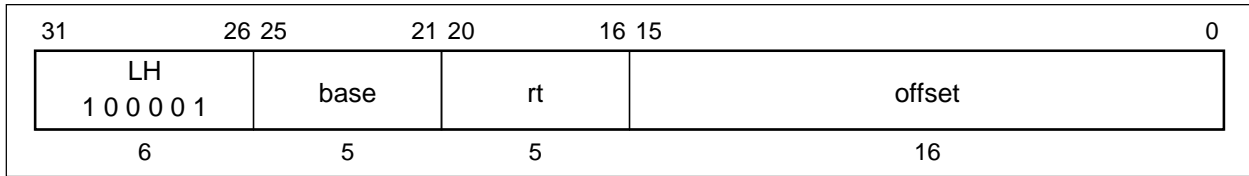

Format:

LH rt, offset (base)

Description:

The 16-bit *offset* is sign-extended and added to the contents of general register *base* to form a virtual address. The contents of the halfword at the memory location specified by the effective address are sign-extended and loaded into general register *rt*.

If the least-significant bit of the effective address is non-zero, an address error exception occurs.

Operation:

```

32      T:  vAddr ← ((offset15)16 || offset15...0) + GPR [base]
          (pAddr, uncached) ← AddressTranslation (vAddr, DATA)
          pAddr ← pAddrPSIZE-1...3 || (pAddr2...0 xor (ReverseEndian2 || 0))
          mem ← LoadMemory (uncached, HALFWORD, pAddr, vAddr, DATA)
          byte ← vAddr2...0 xor (BigEndianCPU2 || 0)
          GPR [rt] ← (mem15 + 8*byte)16 || mem15 + 8*byte...8*byte

64      T:  vAddr ← ((offset15)48 || offset15...0) + GPR [base]
          (pAddr, uncached) ← AddressTranslation (vAddr, DATA)
          pAddr ← pAddrPSIZE-1...3 || (pAddr2...0 xor (ReverseEndian2 || 0))
          mem ← LoadMemory (uncached, HALFWORD, pAddr, vAddr, DATA)
          byte ← vAddr2...0 xor (BigEndianCPU2 || 0)
          GPR [rt] ← (mem15 + 8*byte)48 || mem15 + 8*byte...8*byte
    
```

Exceptions:

- TLB refill exception
- TLB invalid exception
- Bus error exception
- Address error exception

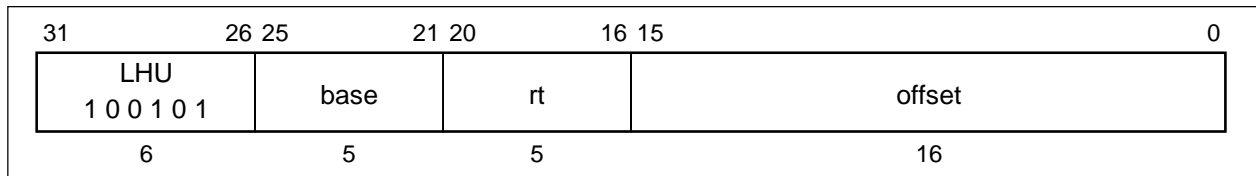
LHU**Load Halfword Unsigned****LHU****Format:**

LHU rt, offset (base)

Description:

The 16-bit *offset* is sign-extended and added to the contents of general register *base* to form a virtual address. The contents of the halfword at the memory location specified by the effective address are zero-extended and loaded into general register *rt*.

If the least-significant bit of the effective address is non-zero, an address error exception occurs.

Operation:

32	<p>T: $vAddr \leftarrow ((offset_{15})^{16} \parallel offset_{15...0}) + GPR [base]$ $(pAddr, uncached) \leftarrow AddressTranslation (vAddr, DATA)$ $pAddr \leftarrow pAddr_{PSIZE-1...3} \parallel (pAddr_{2...0} \text{ xor } (ReverseEndian^2 \parallel 0))$ $mem \leftarrow LoadMemory (uncached, HALFWORD, pAddr, vAddr, DATA)$ $byte \leftarrow vAddr_{2...0} \text{ xor } (BigEndianCPU^2 \parallel 0)$ $GPR [rt] \leftarrow 0^{16} \parallel mem_{15+8*byte...8*byte}$</p>
64	<p>T: $vAddr \leftarrow ((offset_{15})^{48} \parallel offset_{15...0}) + GPR [base]$ $(pAddr, uncached) \leftarrow AddressTranslation (vAddr, DATA)$ $pAddr \leftarrow pAddr_{PSIZE-1...3} \parallel (pAddr_{2...0} \text{ xor } (ReverseEndian^2 \parallel 0))$ $mem \leftarrow LoadMemory (uncached, HALFWORD, pAddr, vAddr, DATA)$ $byte \leftarrow vAddr_{2...0} \text{ xor } (BigEndianCPU^2 \parallel 0)$ $GPR [rt] \leftarrow 0^{48} \parallel mem_{15+8*byte...8*byte}$</p>

Exceptions:

- TLB refill exception
- TLB invalid exception
- Bus error exception
- Address error exception

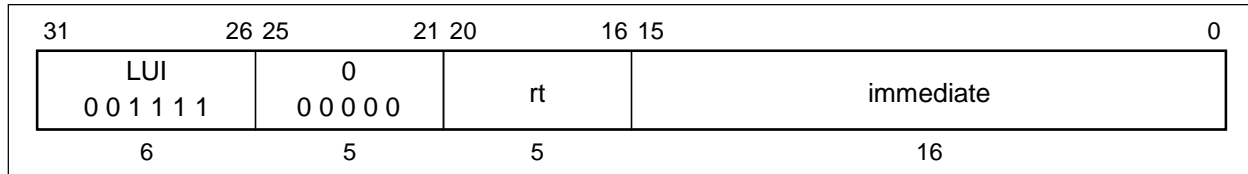
LUI**Load Upper Immediate****LUI****Format:**LUI *rt*, *immediate***Description:**

The 16-bit *immediate* is shifted left 16 bits and concatenated to 16 bits of zeros. The result is placed into general register *rt*. In 64-bit mode, the loaded word is sign-extended.

Operation:

32 T: GPR [*rt*] ← *immediate* || 0¹⁶

64 T: GPR [*rt*] ← (*immediate*₁₅)³² || *immediate* || 0¹⁶

Exceptions:

None

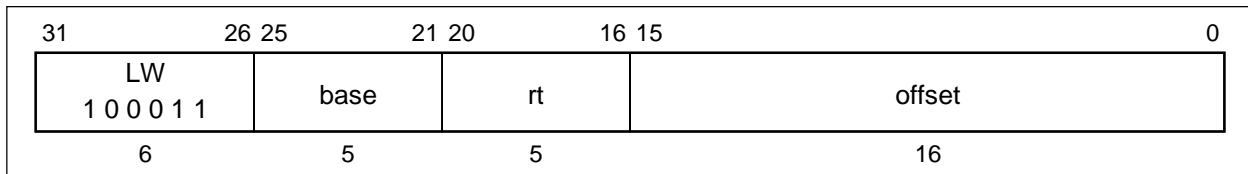
LW**Load Word****LW****Format:**LW *rt*, *offset* (*base*)**Description:**

The 16-bit *offset* is sign-extended and added to the contents of general register *base* to form a virtual address. The contents of the word at the memory location specified by the effective address are loaded into general register *rt*. In 64-bit mode, the loaded word is sign-extended.

If either of the two least-significant bits of the effective address is non-zero, an address error exception occurs.

Operation:

32	<p>T: $vAddr \leftarrow ((offset_{15})^{16} \parallel offset_{15...0}) + GPR [base]$ $(pAddr, uncached) \leftarrow AddressTranslation (vAddr, DATA)$ $pAddr \leftarrow pAddr_{PSIZE-1...3} \parallel (pAddr_{2...0} \text{ xor } (ReverseEndian \parallel 0^2))$ $mem \leftarrow LoadMemory (uncached, WORD, pAddr, vAddr, DATA)$ $byte \leftarrow vAddr_{2...0} \text{ xor } (BigEndianCPU \parallel 0^2)$ $GPR [rt] \leftarrow mem_{31+8*byte...8*byte}$</p>
64	<p>T: $vAddr \leftarrow ((offset_{15})^{48} \parallel offset_{15...0}) + GPR [base]$ $(pAddr, uncached) \leftarrow AddressTranslation (vAddr, DATA)$ $pAddr \leftarrow pAddr_{PSIZE-1...3} \parallel (pAddr_{2...0} \text{ xor } (ReverseEndian \parallel 0^2))$ $mem \leftarrow LoadMemory (uncached, WORD, pAddr, vAddr, DATA)$ $byte \leftarrow vAddr_{2...0} \text{ xor } (BigEndianCPU \parallel 0^2)$ $GPR [rt] \leftarrow (mem_{31+8*byte})^{32} \parallel mem_{31+8*byte...8*byte}$</p>

Exceptions:

- TLB refill exception
- TLB invalid exception
- Bus error exception
- Address error exception

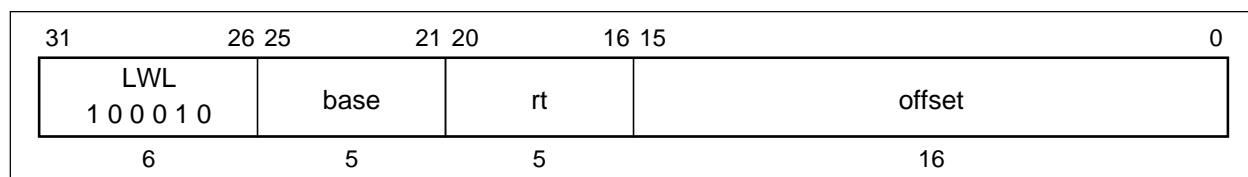
LWL**Load Word Left****LWL****Format:**

LWL rt, offset (base)

Description:

This instruction can be used in combination with the LWR instruction to load a register with four consecutive bytes from memory, when the bytes cross a word boundary. LWL loads the left portion of the register with the appropriate part of the high-order word; LWR loads the right portion of the register with the appropriate part of the low-order word.

The LWL instruction adds its sign-extended 16-bit *offset* to the contents of general register *base* to form a virtual address that can specify an arbitrary byte. It reads bytes only from the word in memory that contains the specified starting byte. From one to four bytes will be loaded, depending on the starting byte specified. In 64-bit mode, the loaded word is sign-extended.

Conceptually, it starts at the specified byte in memory and loads that byte into the high-order (left-most) byte of the register; then it loads bytes from memory into the register until it reaches the low-order byte of the word in memory. The least-significant (right-most) byte(s) of the register will not be changed.

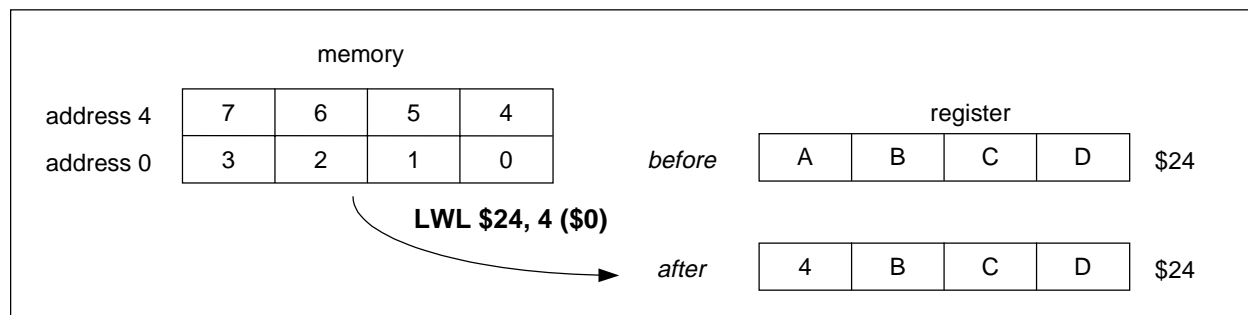

LWL**Load Word Left
(Continued)****LWL**

The contents of general register *rt* are internally bypassed within the processor so that no NOP is needed between an immediately preceding load instruction which specifies register *rt* and a following LWL (or LWR) instruction which also specifies register *rt*.

No address error exceptions due to alignment are possible.

Operation:

```

32    T:  vAddr ← ((offset15)16 || offset15...0) + GPR [base]
        (pAddr, uncached) ← AddressTranslation (vAddr, DATA)
        pAddr ← pAddrPSIZE-1...3 || (pAddr2...0 xor ReverseEndian3)
        if BigEndianMem = 0 then
            pAddr ← pAddrPSIZE-1...2 || 02
        endif
        byte ← vAddr1...0 xor BigEndianCPU2
        word ← vAddr2 xor BigEndianCPU
        mem ← LoadMemory (uncached, byte, pAddr, vAddr, DATA)
        temp ← mem32*word+8*byte+7...32*word || GPR [rt]23-8*byte...0
        GPR [rt] ← temp

64    T:  vAddr ← ((offset15)48 || offset15...0) + GPR [base]
        (pAddr, uncached) ← AddressTranslation (vAddr, DATA)
        pAddr ← pAddrPSIZE-1...3 || (pAddr2...0 xor ReverseEndian3)
        if BigEndianMem = 0 then
            pAddr ← pAddrPSIZE-1...2 || 02
        endif
        byte ← vAddr1...0 xor BigEndianCPU2
        word ← vAddr2 xor BigEndianCPU
        mem ← LoadMemory (uncached, 0 || byte, pAddr, vAddr, DATA)
        temp ← mem32*word+8*byte+7...32*word || GPR [rt]23-8*byte...0
        GPR [rt] ← (temp31)32 || temp

```

LWL

Load Word Left (Continued)

LWL

Given a doubleword in a register and a doubleword in memory, the operation of LWL is as follows:

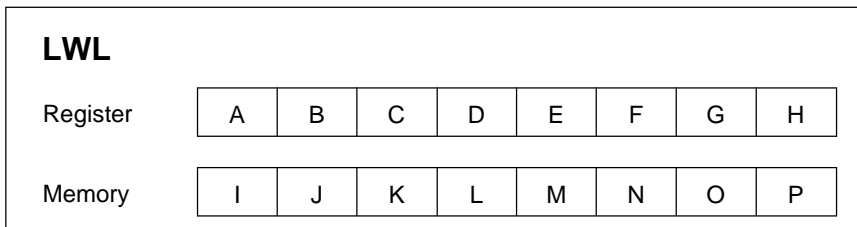

vAddr _{2..0}	BigEndianCPU = 0		
	destination	type	offset (LEM)
0	S S S S P F G H	0	0
1	S S S S O P G H	1	0
2	S S S S N O P H	2	0
3	S S S S M N O P	3	0
4	S S S S L F G H	0	4
5	S S S S K L G H	1	4
6	S S S S J K L H	2	4
7	S S S S I J K L	3	4

- LEM* Little-endian memory (BigEndianMem = 0)
- Type* AccessType (see **Figure 3-2**) sent to memory
- Offset* pAddr_{2..0} sent to memory
- S* sign-extend of destination₃₁

Exceptions:

- TLB refill exception
- TLB invalid exception
- Bus error exception
- Address error exception

LWR

Load Word Right

LWR

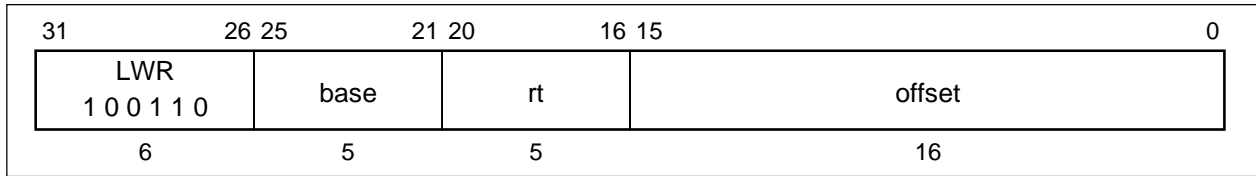

Format:

LWR rt, offset (base)

Description:

This instruction can be used in combination with the LWL instruction to load a register with four consecutive bytes from memory, when the bytes cross a word boundary. LWR loads the right portion of the register with the appropriate part of the low-order word; LWL loads the left portion of the register with the appropriate part of the high-order word.

The LWR instruction adds its sign-extended 16-bit *offset* to the contents of general register *base* to form a virtual address that can specify an arbitrary byte. It reads bytes only from the word in memory that contains the specified starting byte. From one to four bytes will be loaded, depending on the starting byte specified. In 64-bit mode, the loaded word is sign-extended.

Conceptually, it starts at the specified byte in memory and loads that byte into the low-order (right-most) byte of the register; then it loads bytes from memory into the register until it reaches the high-order byte of the word in memory. The most significant (left-most) byte(s) of the register will not be changed.

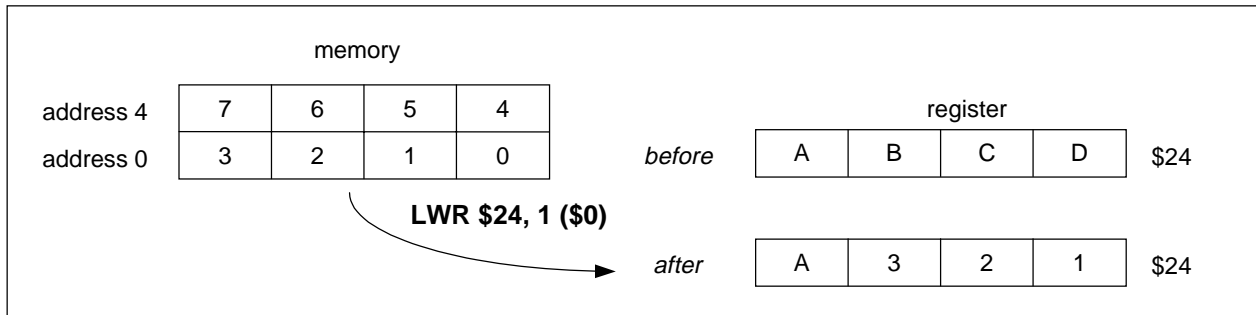

LWR**Load Word Right
(Continued)****LWR**

The contents of general register *rt* are internally bypassed within the processor so that no NOP is needed between an immediately preceding load instruction which specifies register *rt* and a following LWR (or LWL) instruction which also specifies register *rt*.

No address error exceptions due to alignment are possible.

Operation:

```

32    T:  vAddr ← ((offset15)16 || offset15...0) + GPR [base]
        (pAddr, uncached) ← AddressTranslation (vAddr, DATA)
        pAddr ← pAddrPSIZE-1...3 || (pAddr2...0 xor ReverseEndian3)
        if BigEndianMem = 1 then
            pAddr ← pAddrPSIZE-1...3 || 03
        endif
        byte ← vAddr1...0 xor BigEndianCPU2
        word ← vAddr2 xor BigEndianCPU
        mem ← LoadMemory (uncached, 0 || byte, pAddr, vAddr, DATA)
        temp ← GPR [rt]31...32-8*byte || mem31+32*word...32*word+8*byte
        GPR [rt] ← temp

64    T:  vAddr ← ((offset15)48 || offset15...0) + GPR [base]
        (pAddr, uncached) ← AddressTranslation (vAddr, DATA)
        pAddr ← pAddrPSIZE-1...3 || (pAddr2...0 xor ReverseEndian3)
        if BigEndianMem = 1 then
            pAddr ← pAddrPSIZE-1...3 || 03
        endif
        byte ← vAddr1...0 xor BigEndianCPU2
        word ← vAddr2 xor BigEndianCPU
        mem ← LoadMemory (uncached, WORD-byte, pAddr, vAddr, DATA)
        temp ← GPR [rt]31...32-8*byte || mem31+32*word...32*word+8*byte
        GPR [rt] ← (temp31)32 || temp

```

LWR

Load Word Right (Continued)

LWR

Given a word in a register and a word in memory, the operation of LWR is as follows:

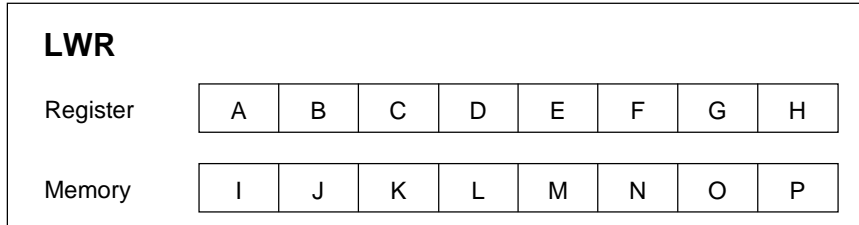

vAddr _{2..0}	BigEndianCPU = 0		
	destination	type	offset (LEM)
0	S S S S M N O P	3	0
1	S S S S E M N O	2	1
2	S S S S E F M N	1	2
3	S S S S E F G M	0	3
4	S S S S I J K L	3	4
5	S S S S E I J K	2	5
6	S S S S E F I J	1	6
7	S S S S E F G I	0	7

- LEM* Little-endian memory (BigEndianMem = 0)
- Type* AccessType (see **Figure 3-2**) sent to memory
- Offset* pAddr_{2..0} sent to memory
- S* sign-extend of destination₃₁

Exceptions:

- TLB refill exception
- TLB invalid exception
- Bus error exception
- Address error exception

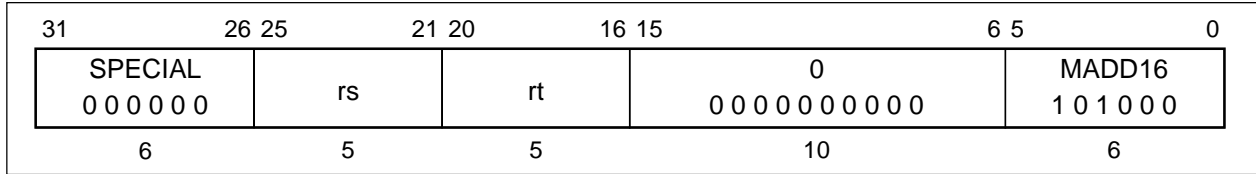
MADD16**Multiply and Add 16-bit integer****MADD16****Format:**

MADD16 rs, rt

Description:

The contents of general registers *rs* and *rt* are multiplied, treating both operands as 16-bit 2's complement values. The operand[62:15] must be valid 15-bit, sign-extended values. If not, the results is unpredictable.

This multiplied result and the 64-bit data joined special register *HI* to *LO* are added to form the result.

No integer overflow exception occurs under any circumstances.

When the operation completes, the low-order word of the double result is loaded into special register *LO*, and the high-order word of the double result is loaded into special register *HI*.

The following Table are hazard cycles between MADD16 and other instructions.

Instruction sequence	No. of cycles
MULT/MULTU → MADD16	1 Cycle
DMULT/DMULTU → MADD16	4 Cycles
DIV/DIVU → MADD16	36 Cycles
DDIV/DDIVU → MADD16	68 Cycles
MFHI/MFLO → MADD16	2 Cycles
DMADD16 → MADD16	0 Cycles
MADD16 → MADD16	0 Cycles

Operation:

32, 64 T: temp1 ← GPR [rs] * GPR [rt]
temp2 ← temp1 + (HI_{31...0} || LO_{31...0})
LO ← (temp1₃₁)³² || temp2_{31...0}
HI ← (temp2₆₃)³² || temp2_{63...32}

Exceptions:

None

MFC0 Move From System Control Coprocessor MFC0

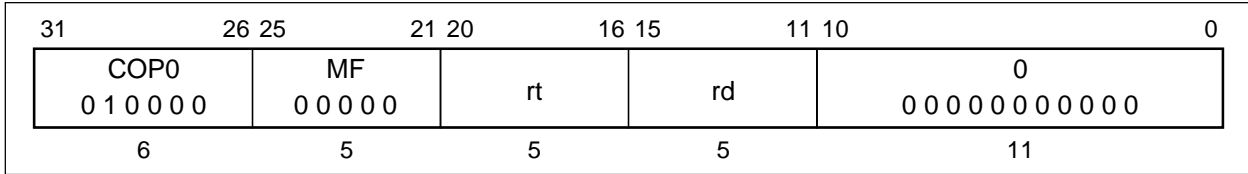
**Format:**MFC0 *rt*, *rd***Description:**

The contents of coprocessor register *rd* of the CP0 are loaded into general register *rt*.

Operation:

32	T: data ← CPR [0, <i>rd</i>] T+1: GPR [<i>rt</i>] ← data
64	T: data ← CPR [0, <i>rd</i>] T+1: GPR [<i>rt</i>] ← (data ₃₁) ³² data _{31...0}

Exceptions:

Coprocessor unusable exception (user and supervisor mode if CP0 not enabled)

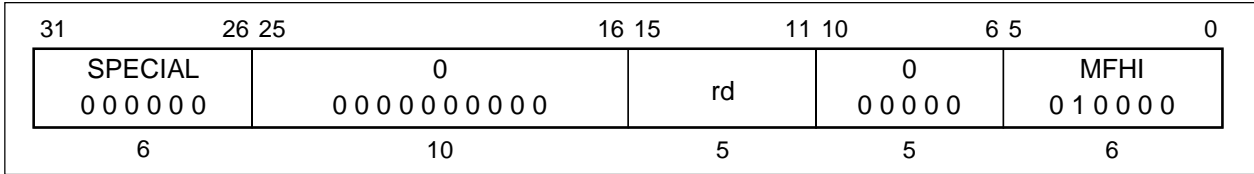
MFHI**Move From HI****MFHI****Format:**

MFHI rd

Description:

The contents of special register *HI* are loaded into general register *rd*.

To ensure proper operation in the event of interruptions, the two instructions which follow a MFHI instruction may not be any of the instructions which modify the *HI* register: MULT, MULTU, DIV, DIVU, MTHI, DMULT, DMULTU, DDIV, DDIVU.

Operation:

32, 64 T: GPR [rd] ← HI

Exceptions:

None

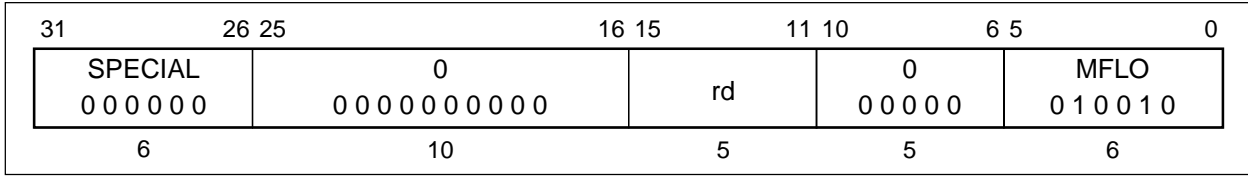
MFLO**Move From LO****MFLO****Format:**

MFLO rd

Description:

The contents of special register *LO* are loaded into general register *rd*.

To ensure proper operation in the event of interruptions, the two instructions which follow a MFLO instruction may not be any of the instructions which modify the *LO* register: MULT, MULTU, DIV, DIVU, MTLO, DMULT, DMULTU, DDIV, DDIVU.

Operation:

32, 64 T: GPR [rd] ← LO

Exceptions:

None

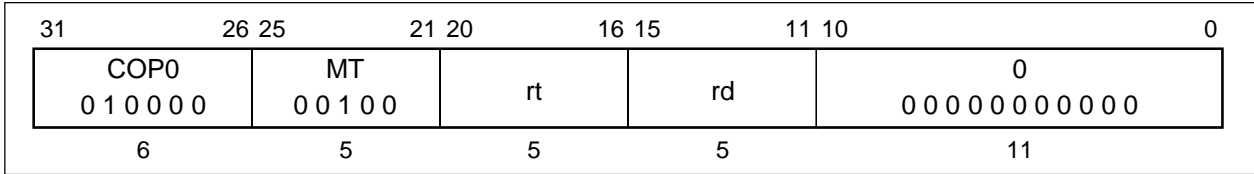
MTC0**Move To Coprocessor0****MTC0****Format:**MTC0 *rt*, *rd***Description:**

The contents of general register *rt* are loaded into coprocessor register *rd* of coprocessor 0.

Because the state of the virtual address translation system may be altered by this instruction, the operation of load instructions, store instructions, and TLB operations immediately prior to and after this instruction are undefined.

When using a register used by the MTC0 by means of instructions before and after it, refer to Chapter 29 and place the instructions in the appropriate location.

Operation:

32, 64 T: data ← GPR [*rt*]
T+1: CPR [0, *rd*] ← data

Exceptions:

Coprocessor unusable exception (user and supervisor mode if CP0 not enabled)

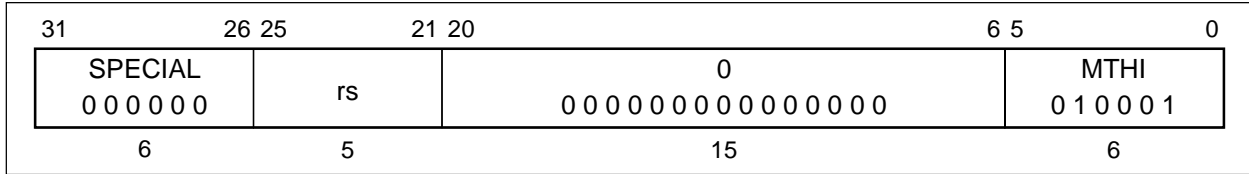
MTHI**Move To HI****MTHI****Format:**

MTHI rs

Description:

The contents of general register *rs* are loaded into special register *HI*.

If a MTHI operation is executed following a MULT, MULTU, DIV, or DIVU instruction, but before any MFLO, MFHI, MTLO, or MTHI instructions, the contents of special register *HI* are undefined.

Operation:

32, 64	T-2: HI	← undefined
	T-1: HI	← undefined
	T: HI	← GPR [rs]

Exceptions:

None

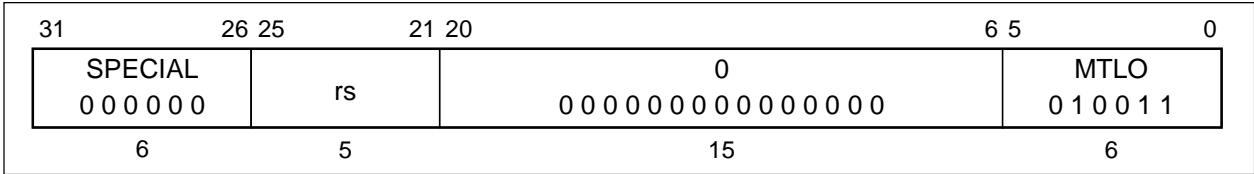
MTLO**Move To LO****MTLO****Format:**

MTLO rs

Description:

The contents of general register *rs* are loaded into special register *LO*.

If an MTLO operation is executed following a MULT, MULTU, DIV, or DIVU instruction, but before any MFLO, MFHI, MTLO, or MTHI instructions, the contents of special register *LO* are undefined.

Operation:

32, 64 T-2: LO ← undefined
 T-1: LO ← undefined
 T: LO ← GPR [rs]

Exceptions:

None

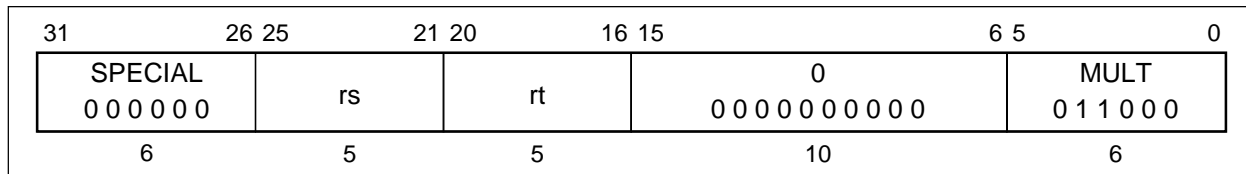
MULT**Multiply****MULT****Format:**MULT *rs*, *rt***Description:**

The contents of general registers *rs* and *rt* are multiplied, treating both operands as signed 32-bit integer. No integer overflow exception occurs under any circumstances. In 64-bit mode, the operands must be valid 32-bit, sign-extended values.

When the operation completes, the low-order word of the double result is loaded into special register *LO*, and the high-order word of the double result is loaded into special register *HI*.

If either of the two preceding instructions is MFHI or MFLO, the results of these instructions are undefined. Correct operation requires separating reads of *HI* or *LO* from writes by a minimum of two other instructions.

Operation:

32	T-2: LO ← undefined HI ← undefined
	T-1: LO ← undefined HI ← undefined
	T: t ← GPR [<i>rs</i>] * GPR [<i>rt</i>] LO ← t _{31...0} HI ← t _{63...32}
64	T-2: LO ← undefined HI ← undefined
	T-1: LO ← undefined HI ← undefined
	T: t ← GPR [<i>rs</i>] _{31...0} * GPR [<i>rt</i>] _{31...0} LO ← (t ₃₁) ³² t _{31...0} HI ← (t ₆₃) ³² t _{63...32}

Exceptions:

None

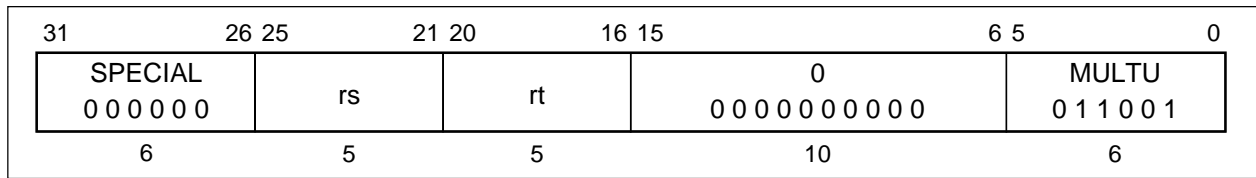
MULTU**Multiply Unsigned****MULTU****Format:**

MULTU rs, rt

Description:

The contents of general register *rs* and the contents of general register *rt* are multiplied, treating both operands as unsigned values. No overflow exception occurs under any circumstances. In 64-bit mode, the operands must be valid 32-bit, sign-extended values.

When the operation completes, the low-order word of the double result is loaded into special register *LO*, and the high-order word of the double result is loaded into special register *HI*.

If either of the two preceding instructions is MFHI or MFLO, the results of these instructions are undefined. Correct operation requires separating reads of *HI* or *LO* from writes by a minimum of two instructions.

Operation:

32	T-2: LO ← undefined HI ← undefined T-1: LO ← undefined HI ← undefined T: t ← (0 GPR [rs]) * (0 GPR [rt]) LO ← t _{31...0} HI ← t _{63...32}
64	T-2: LO ← undefined HI ← undefined T-1: LO ← undefined HI ← undefined T: t ← (0 GPR [rs] _{31...0}) * (0 GPR [rt] _{31...0}) LO ← (t ₃₁) ³² t _{31...0} HI ← (t ₆₃) ³² t _{63...32}

Exceptions:

None

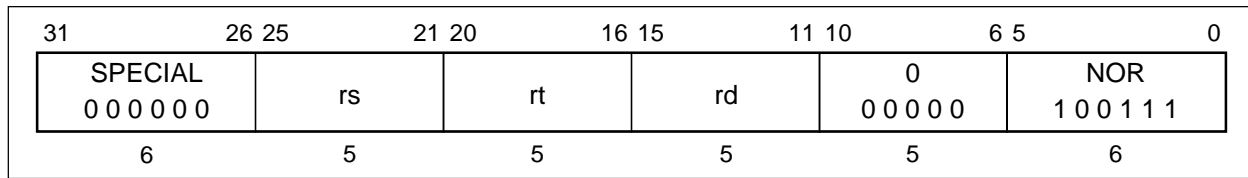
NOR**Nor****NOR****Format:**

NOR rd, rs, rt

Description:

The contents of general register *rs* are combined with the contents of general register *rt* in a bit-wise logical NOR operation. The result is placed into general register *rd*.

Operation:

32, 64 T: $GPR[rd] \leftarrow GPR[rs] \text{ nor } GPR[rt]$

Exceptions:

None

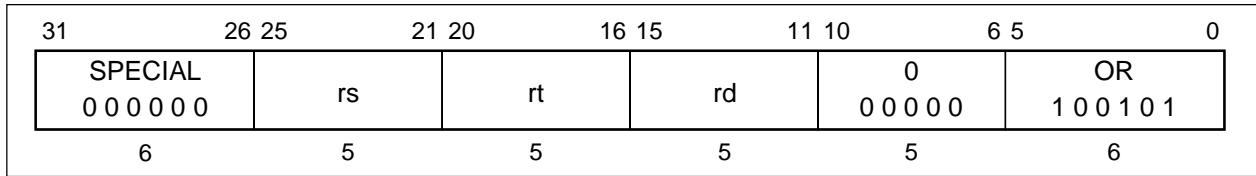
OR**Or****OR****Format:**OR *rd*, *rs*, *rt***Description:**

The contents of general register *rs* are combined with the contents of general register *rt* in a bit-wise logical OR operation. The result is placed into general register *rd*.

Operation:
 32, 64 T: GPR [*rd*] ← GPR [*rs*] or GPR [*rt*]
Exceptions:

None

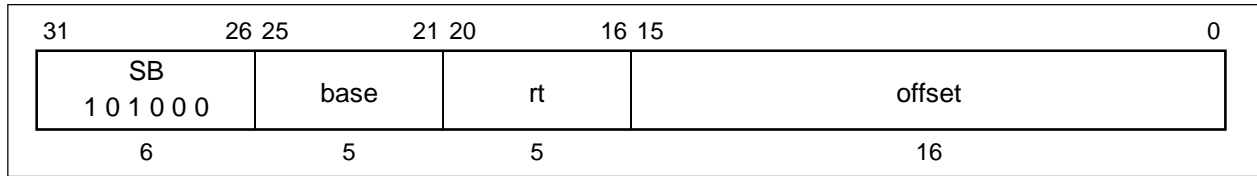
SB**Store Byte****SB****Format:**SB *rt*, *offset* (*base*)**Description:**

The 16-bit *offset* is sign-extended and added to the contents of general register *base* to form a virtual address. The least-significant byte of register *rt* is stored at the effective address.

Operation:

```

32    T:  vAddr ← ((offset15)16 || offset15...0) + GPR [base]
        (pAddr, uncached) ← AddressTranslation (vAddr, DATA)
        pAddr ← pAddrPSIZE-1...3 || (pAddr2...0 xor (ReverseEndian3))
        byte ← vAddr2...0 xor (BigEndianCPU3)
        data ← GPR [rt]63-8*byte...0 || 08*byte
        StoreMemory (uncached, BYTE, data, pAddr, vAddr, DATA)

64    T:  vAddr ← ((offset15)48 || offset15...0) + GPR [base]
        (pAddr, uncached) ← AddressTranslation (vAddr, DATA)
        pAddr ← pAddrPSIZE-1...3 || (pAddr2...0 xor (ReverseEndian3))
        byte ← vAddr2...0 xor (BigEndianCPU3)
        data ← GPR [rt]63-8*byte...0 || 08*byte
        StoreMemory (uncached, BYTE, data, pAddr, vAddr, DATA)

```

Exceptions:

- TLB refill exception
- TLB invalid exception
- TLB modification exception
- Bus error exception
- Address error exception

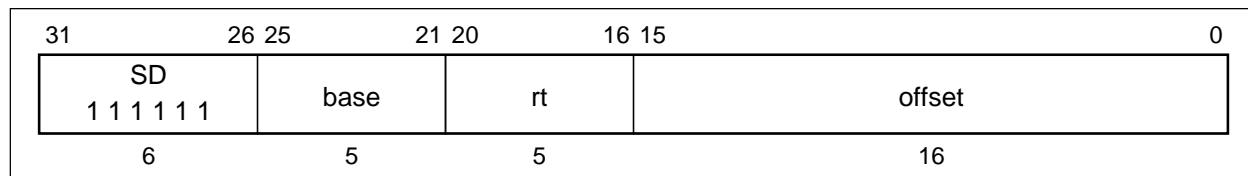
SD**Store Doubleword****SD****Format:**SD *rt*, *offset* (*base*)**Description:**

The 16-bit *offset* is sign-extended and added to the contents of general register *base* to form a virtual address. The contents of general register *rt* are stored at the memory location specified by the effective address.

If either of the three least-significant bits of the effective address are non-zero, an address error exception occurs.

This operation is defined for the VR4181 operating in 64-bit mode or in 32-bit kernel mode. Execution of this instruction in 32-bit user or supervisor mode causes a reserved instruction exception.

Operation:

```

64   T:  vAddr ← ((offset15)48 || offset15...0) + GPR [base]
      (pAddr, uncached) ← AddressTranslation (vAddr, DATA)
      data ← GPR [rt]
      StoreMemory (uncached, DOUBLEWORD, data, pAddr, vAddr, DATA)

```

Exceptions:

- TLB refill exception
- TLB invalid exception
- TLB modification exception
- Bus error exception
- Address error exception
- Reserved instruction exception (VR4181 in 32-bit user mode, VR4181 in 32-bit supervisor mode)

SDL

Store Doubleword Left

SDL

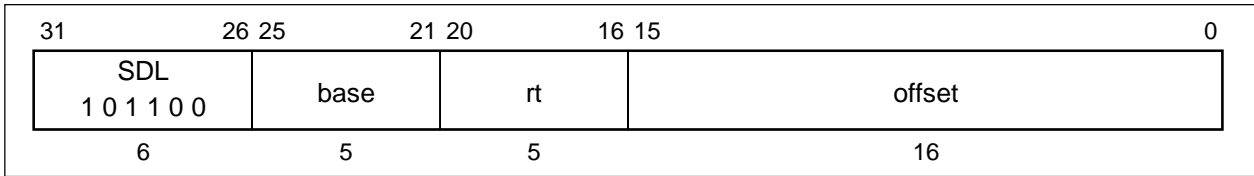

Format:

SDL rt, offset (base)

Description:

This instruction can be used with the SDR instruction to store the contents of a register into eight consecutive bytes of memory, when the bytes cross a doubleword boundary. SDL stores the left portion of the register into the appropriate part of the high-order doubleword of memory; SDR stores the right portion of the register into the appropriate part of the low-order doubleword.

The SDL instruction adds its sign-extended 16-bit *offset* to the contents of general register *base* to form a virtual address that may specify an arbitrary byte. It alters only the word in memory that contains that byte. From one to four bytes will be stored, depending on the starting byte specified.

Conceptually, it starts at the most-significant byte of the register and copies it to the specified byte in memory; then it copies bytes from register to memory until it reaches the low-order byte of the word in memory.

No address error exceptions due to alignment are possible.

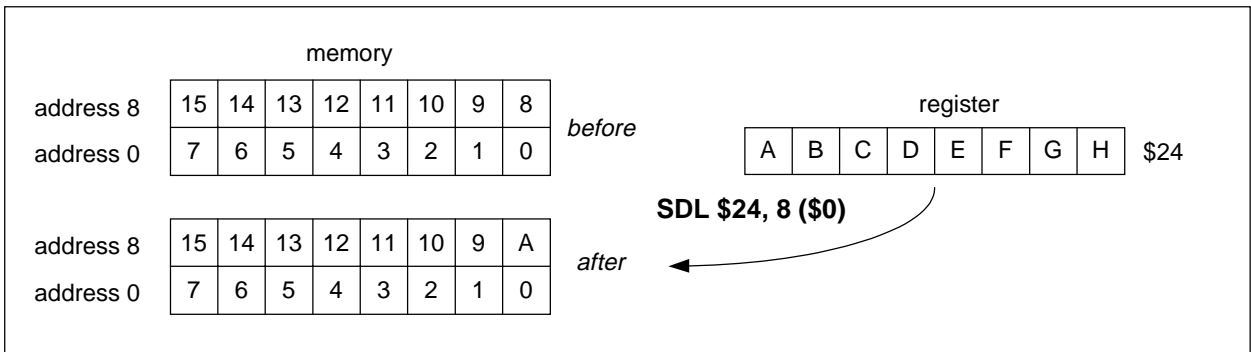

SDL**Store Doubleword Left
(Continued)****SDL**

This operation is defined for the VR4181 operating in 64-bit mode or in 32-bit kernel mode. Execution of this instruction in 32-bit user or supervisor mode causes a reserved instruction exception.

Operation:

```

64    T:  vAddr ← ((offset15)48 || offset15...0) + GPR [base]
        (pAddr, uncached) ← AddressTranslation (vAddr, DATA)
        pAddr ← pAddrPSIZE - 1...3 || (pAddr2...0 xor ReverseEndian3)
        if BigEndianMem = 0 then
            pAddr ← pAddrPSIZE - 1...3 || 03
        endif
        byte ← vAddr2...0 xor BigEndianCPU3
        data ← 056 - 8*byte || GPR [rt]63...56 - 8*byte
        StoreMemory (uncached, byte, data, pAddr, vAddr, DATA)

```

SDL

**Store Doubleword Left
(Continued)**

SDL

Given a doubleword in a register and a doubleword in memory, the operation of SDL is as follows:

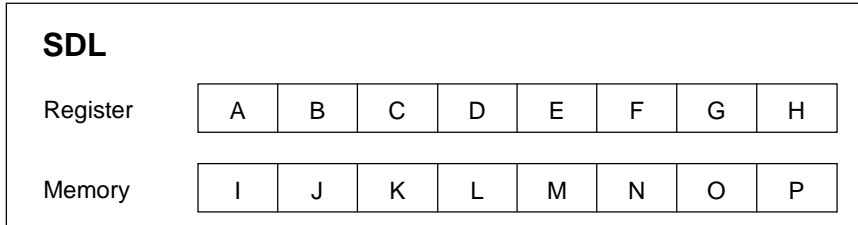

vAddr _{2..0}	BigEndianCPU = 0		
	destination	type	offset (LEM)
0	I J K L M N O A	0	0
1	I J K L M N A B	1	0
2	I J K L M A B C	2	0
3	I J K L A B C D	3	0
4	I J K A B C D E	4	0
5	I J A B C D E F	5	0
6	I A B C D E F G	6	0
7	A B C D E F G H	7	0

- LEM* Little-endian memory (BigEndianMem = 0)
- Type* AccessType (see **Figure 3-2**) sent to memory
- Offset* pAddr_{2..0} sent to memory

Exceptions:

- TLB refill exception
- TLB invalid exception
- TLB modification exception
- Bus error exception
- Address error exception
- Reserved instruction exception (Vr4181 in 32-bit user mode, Vr4181 in 32-bit supervisor mode)

SDR Store Doubleword Right SDR

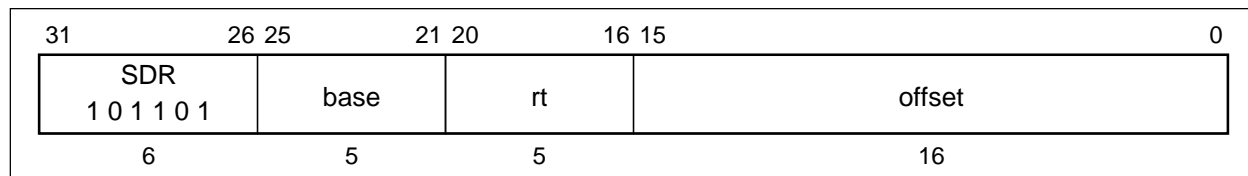
**Format:**

SDR rt, offset (base)

Description:

This instruction can be used with the SDL instruction to store the contents of a register into eight consecutive bytes of memory, when the bytes cross a boundary between two doublewords. SDR stores the right portion of the register into the appropriate part of the low-order doubleword; SDL stores the left portion of the register into the appropriate part of the low-order doubleword of memory.

The SDR instruction adds its sign-extended 16-bit *offset* to the contents of general register *base* to form a virtual address that may specify an arbitrary byte. It alters only the word in memory that contains that byte. From one to eight bytes will be stored, depending on the starting byte specified.

Conceptually, it starts at the least-significant (rightmost) byte of the register and copies it to the specified byte in memory; then it copies bytes from register to memory until it reaches the high-order byte of the word in memory. No address error exceptions due to alignment are possible.

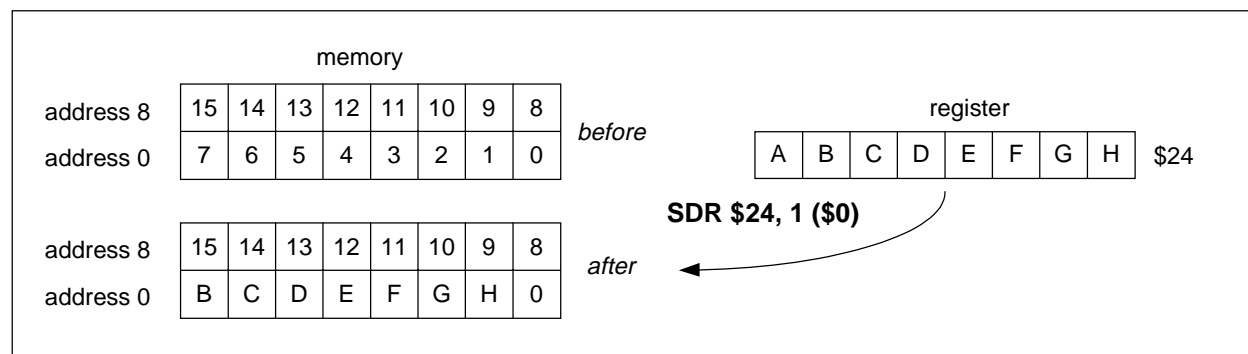

SDR**Store Doubleword Right
(Continued)****SDR**

This operation is defined for the V_R4181 operating in 64-bit mode or in 32-bit kernel mode. Execution of this instruction in 32-bit user or supervisor mode causes a reserved instruction exception.

Operation:

```

64    T:  vAddr ← ((offset15)48 || offset15...0) + GPR [base]
        (pAddr, uncached) ← AddressTranslation (vAddr, DATA)
        pAddr ← pAddrPSIZE-1...3 || (pAddr2...0 xor ReverseEndian3)
        if BigEndianMem = 0 then
            pAddr ← pAddrPSIZE-1...3 || 03
        endif
        byte ← vAddr2...0 xor BigEndianCPU3
        data ← GPR [rt]63-8*byte || 08*byte
        StoreMemory (uncached, DOUBLEWORD-byte, data, pAddr, vAddr, DATA)

```

SDR

**Store Doubleword Right
(Continued)**

SDR

Given a doubleword in a register and a doubleword in memory, the operation of SDR is as follows:

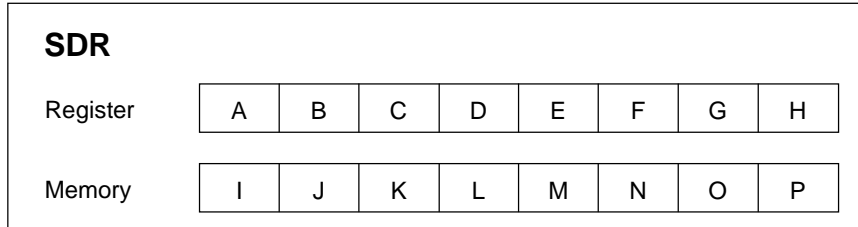

vAddr _{2..0}	BigEndianCPU = 0		
	destination	type	offset (LEM)
0	A B C D E F G H	7	0
1	B C D E F G H P	6	1
2	C D E F G H O P	5	2
3	D E F G H N O P	4	3
4	E F G H M N O P	3	4
5	F G H L M N O P	2	5
6	G H K L M N O P	1	6
7	H J K L M N O P	0	7

- LEM* Little-endian memory (BigEndianMem = 0)
- Type* AccessType (see **Figure 3-2**) sent to memory
- Offset* pAddr_{2..0} sent to memory

Exceptions:

- TLB refill exception
- TLB invalid exception
- TLB modification exception
- Bus error exception
- Address error exception
- Reserved instruction exception (VR4181 in 32-bit user mode, VR4181 in 32-bit supervisor mode)

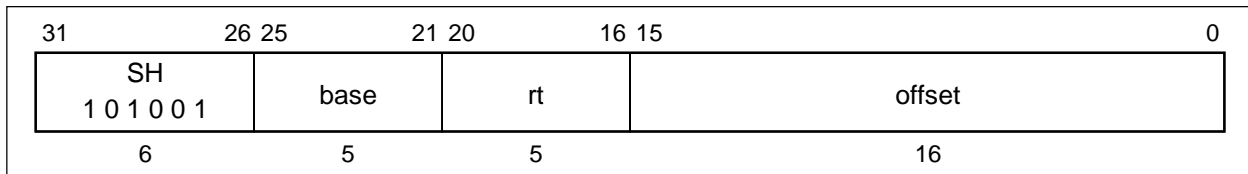
SH**Store Halfword****SH****Format:**SH *rt*, *offset* (*base*)**Description:**

The 16-bit *offset* is sign-extended and added to the contents of general register *base* to form an unsigned effective address. The least-significant halfword of register *rt* is stored at the effective address. If the least-significant bit of the effective address is non-zero, an address error exception occurs.

Operation:

32	<p>T: $vAddr \leftarrow ((offset_{15})^{16} \parallel offset_{15...0}) + GPR [base]$ $(pAddr, uncached) \leftarrow AddressTranslation (vAddr, DATA)$ $pAddr \leftarrow pAddr_{PSIZE-1...3} \parallel (pAddr_{2...0} \text{ xor } (ReverseEndian^2 \parallel 0))$ $byte \leftarrow vAddr_{2...0} \text{ xor } (BigEndianCPU^2 \parallel 0)$ $data \leftarrow GPR [rt]_{63-8*byte...0} \parallel 0^{8*byte}$ StoreMemory (uncached, HALFWORD, data, pAddr, vAddr, DATA)</p>
64	<p>T: $vAddr \leftarrow ((offset_{15})^{48} \parallel offset_{15...0}) + GPR [base]$ $(pAddr, uncached) \leftarrow AddressTranslation (vAddr, DATA)$ $pAddr \leftarrow pAddr_{PSIZE-1...3} \parallel (pAddr_{2...0} \text{ xor } (ReverseEndian^2 \parallel 0))$ $byte \leftarrow vAddr_{2...0} \text{ xor } (BigEndianCPU^2 \parallel 0)$ $data \leftarrow GPR [rt]_{63-8*byte...0} \parallel 0^{8*byte}$ StoreMemory (uncached, HALFWORD, data, pAddr, vAddr, DATA)</p>

Exceptions:

- TLB refill exception
- TLB invalid exception
- TLB modification exception
- Bus error exception
- Address error exception

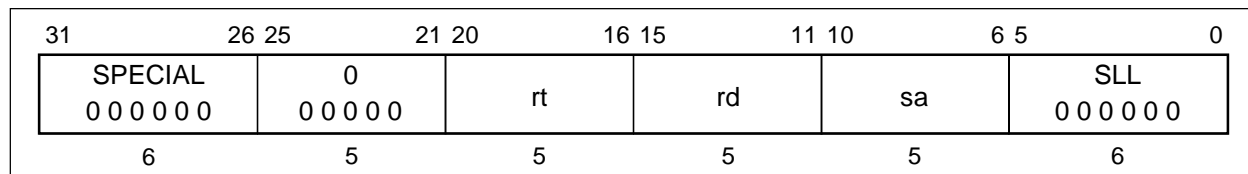
SLL**Shift Left Logical****SLL****Format:**

SLL rd, rt, sa

Description:

The contents of general register *rt* are shifted left by *sa* bits, inserting zeros into the low-order bits.

The result is placed in register *rd*.

In 64-bit mode, the 32-bit result is sign-extended when placed in the destination register. It is sign extended for all shift amounts, including zero; SLL with zero shift amount truncates a 64-bit value to 32 bits and then sign extends this 32-bit value. SLL, unlike nearly all other word operations, does not require an operand to be a properly sign-extended word value to produce a valid sign-extended word result.

Operation:

32 T: $\text{GPR}[\text{rd}] \leftarrow \text{GPR}[\text{rt}]_{31-\text{sa}..0} \parallel 0^{\text{sa}}$

64 T: $s \leftarrow 0 \parallel \text{sa}$
 $\text{temp} \leftarrow \text{GPR}[\text{rt}]_{31-s..0} \parallel 0^s$
 $\text{GPR}[\text{rd}] \leftarrow (\text{temp}_{31})^{32} \parallel \text{temp}$

Exceptions:

None

Remark SLL with a shift amount of zero may be treated as a NOP by some assemblers, at some optimization levels. If using SLL with a zero shift to truncate 64-bit values, check the assembler you are using.

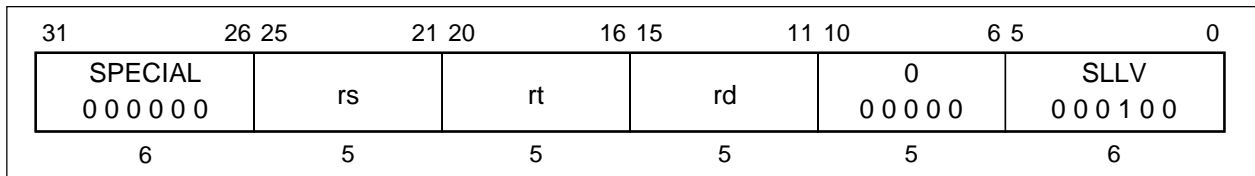
SLLV**Shift Left Logical Variable****SLLV****Format:**

SLLV rd, rt, rs

Description:

The contents of general register *rt* are shifted left the number of bits specified by the low-order five bits contained in general register *rs*, inserting zeros into the low-order bits.

The result is placed in register *rd*.

In 64-bit mode, the 32-bit result is sign-extended when placed in the destination register. It is sign extended for all shift amounts, including zero; SLLV with zero shift amount truncates a 64-bit value to 32 bits and then sign extends this 32-bit value. SLLV, unlike nearly all other word operations, does not require an operand to be a properly sign-extended word value to produce a valid sign-extended word result.

Operation:

32	T: $s \leftarrow \text{GPR}[rs]_{4..0}$ $\text{GPR}[rd] \leftarrow \text{GPR}[rt]_{(31-s)..0} \parallel 0^s$
64	T: $s \leftarrow 0 \parallel \text{GPR}[rs]_{4..0}$ $\text{temp} \leftarrow \text{GPR}[rt]_{(31-s)..0} \parallel 0^s$ $\text{GPR}[rd] \leftarrow (\text{temp}_{31})^{32} \parallel \text{temp}$

Exceptions:

None

Remark SLLV with a shift amount of zero may be treated as a NOP by some assemblers, at some optimization levels. If using SLLV with a zero shift to truncate 64-bit values, check the assembler you are using.

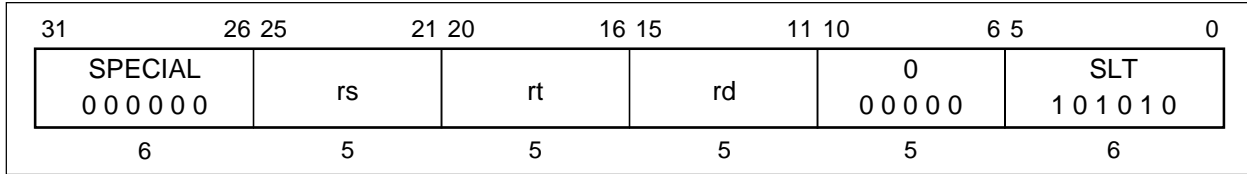
SLT**Set On Less Than****SLT****Format:**

SLT rd, rs, rt

Description:

The contents of general register *rt* are subtracted from the contents of general register *rs*. Considering both quantities as signed integers, if the contents of general register *rs* are less than the contents of general register *rt*, the result is set to one; otherwise the result is set to zero.

The result is placed into general register *rd*.

No integer overflow exception occurs under any circumstances. The comparison is valid even if the subtraction used during the comparison overflows.

Operation:

```

32   T:  if GPR [rs] < GPR [rt] then
        GPR [rd] ← 031 || 1
        else
        GPR [rd] ← 032
        endif

64   T:  if GPR [rs] < GPR [rt] then
        GPR [rd] ← 063 || 1
        else
        GPR [rd] ← 064
        endif

```

Exceptions:

None

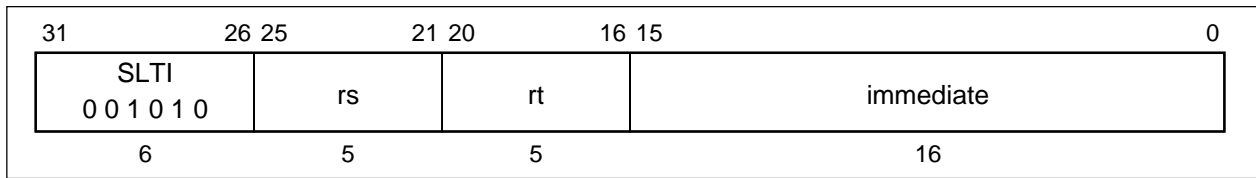
SLTI**Set On Less Than Immediate****SLTI****Format:**

SLTI rt, rs, immediate

Description:

The 16-bit *immediate* is sign-extended and subtracted from the contents of general register *rs*. Considering both quantities as signed integers, if *rs* is less than the sign-extended immediate, the result is set to 1; otherwise the result is set to 0.

The result is placed into general register *rt*.

No integer overflow exception occurs under any circumstances. The comparison is valid even if the subtraction used during the comparison overflows.

Operation:

32	<pre>T: if GPR [rs] < (immediate₁₅)¹⁶ immediate_{15...0} then GPR [rt] ← 0³¹ 1 else GPR [rt] ← 0³² endif</pre>
64	<pre>T: if GPR [rs] < (immediate₁₅)⁴⁸ immediate_{15...0} then GPR [rt] ← 0⁶³ 1 else GPR [rt] ← 0⁶⁴ endif</pre>

Exceptions:

None

SLTIU Set On Less Than Immediate Unsigned SLTIU

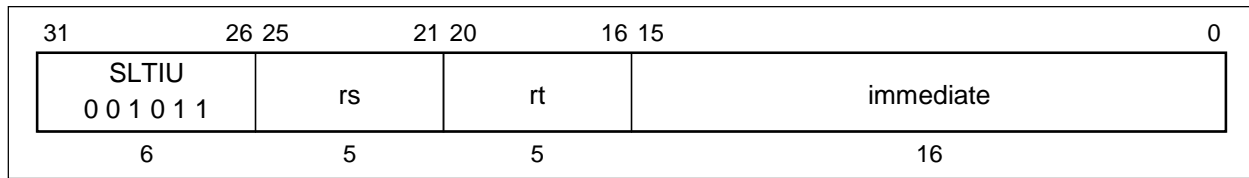
**Format:**

SLTIU *rt*, *rs*, *immediate*

Description:

The 16-bit *immediate* is sign-extended and subtracted from the contents of general register *rs*. Considering both quantities as unsigned integers, if *rs* is less than the sign-extended immediate, the result is set to 1; otherwise the result is set to 0.

The result is placed into general register *rt*.

No integer overflow exception occurs under any circumstances. The comparison is valid even if the subtraction used during the comparison overflows.

Operation:

```

32   T:  if (0 || GPR [rs]) < (0 || (immediate15)16 || immediate15...0) then
        GPR [rt] ← 031 || 1
        else
        GPR [rt] ← 032
        endif

64   T:  if (0 || GPR [rs]) < (0 || (immediate15)48 || immediate15...0) then
        GPR [rt] ← 063 || 1
        else
        GPR [rt] ← 064
        endif

```

Exceptions:

None

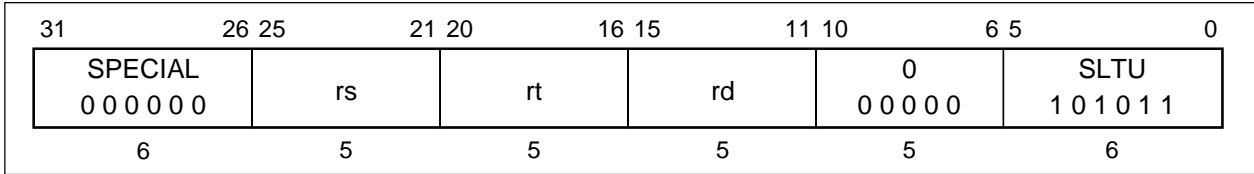
SLTU**Set On Less Than Unsigned****SLTU****Format:**

SLTU rd, rs, rt

Description:

The contents of general register *rt* are subtracted from the contents of general register *rs*. Considering both quantities as unsigned integers, if the contents of general register *rs* are less than the contents of general register *rt*, the result is set to 1; otherwise the result is set to 0.

The result is placed into general register *rd*.

No integer overflow exception occurs under any circumstances. The comparison is valid even if the subtraction used during the comparison overflows.

Operation:

32	<pre>T: if (0 GPR [rs]) < (0 GPR [rt]) then GPR [rd] ← 0³¹ 1 else GPR [rd] ← 0³² endif</pre>
64	<pre>T: if (0 GPR [rs]) < (0 GPR [rt]) then GPR [rd] ← 0⁶³ 1 else GPR [rd] ← 0⁶⁴ endif</pre>

Exceptions:

None

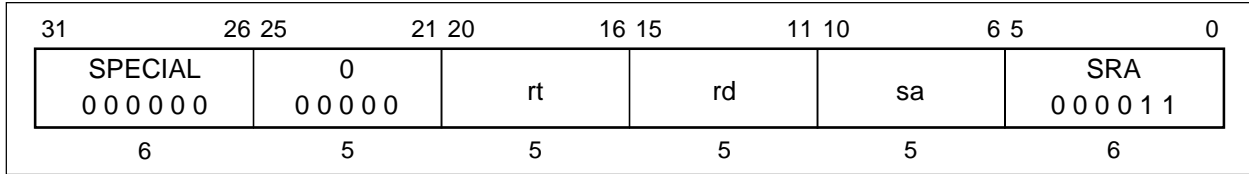
SRA**Shift Right Arithmetic****SRA****Format:**

SRA rd, rt, sa

Description:

The contents of general register *rt* are shifted right by *sa* bits, sign-extending the high-order bits.

The result is placed in register *rd*.

In 64-bit mode, the operand must be a valid sign-extended, 32-bit value.

Operation:

32 T: $\text{GPR}[\text{rd}] \leftarrow (\text{GPR}[\text{rt}]_{31})^{\text{sa}} \parallel \text{GPR}[\text{rt}]_{31 \dots \text{sa}}$

64 T: $s \leftarrow 0 \parallel \text{sa}$
 $\text{temp} \leftarrow (\text{GPR}[\text{rt}]_{31})^s \parallel \text{GPR}[\text{rt}]_{31 \dots s}$
 $\text{GPR}[\text{rd}] \leftarrow (\text{temp}_{31})^{32} \parallel \text{temp}$

Exceptions:

None

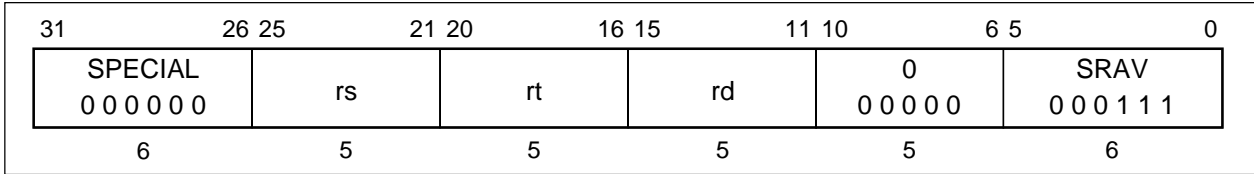
SRAV**Shift Right Arithmetic Variable****SRAV****Format:**

SRAV rd, rt, rs

Description:

The contents of general register *rt* are shifted right by the number of bits specified by the low-order five bits of general register *rs*, sign-extending the high-order bits.

The result is placed in register *rd*.

In 64-bit mode, the operand must be a valid sign-extended, 32-bit value.

Operation:

32	T: $s \leftarrow \text{GPR}[rs]_{4..0}$ $\text{GPR}[rd] \leftarrow (\text{GPR}[rt]_{31})^s \parallel \text{GPR}[rt]_{31..s}$
64	T: $s \leftarrow \text{GPR}[rs]_{4..0}$ $\text{temp} \leftarrow (\text{GPR}[rt]_{31})^s \parallel \text{GPR}[rt]_{31..s}$ $\text{GPR}[rd] \leftarrow (\text{temp}_{31})^{32} \parallel \text{temp}$

Exceptions:

None

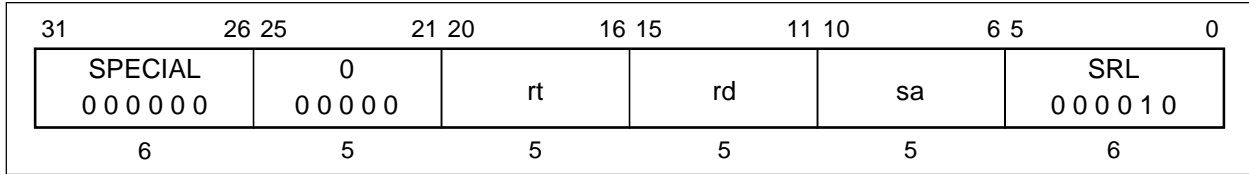
SRL**Shift Right Logical****SRL****Format:**

SRL rd, rt, sa

Description:

The contents of general register *rt* are shifted right by *sa* bits, inserting zeros into the high-order bits.

The result is placed in register *rd*.

In 64-bit mode, the operand must be a valid sign-extended, 32-bit value.

Operation:

32	T:	$\text{GPR}[\text{rd}] \leftarrow 0^{\text{sa}} \parallel \text{GPR}[\text{rt}]_{31 \dots \text{sa}}$
64	T:	$s \leftarrow 0 \parallel \text{sa}$ $\text{temp} \leftarrow 0^s \parallel \text{GPR}[\text{rt}]_{31 \dots s}$ $\text{GPR}[\text{rd}] \leftarrow (\text{temp}_{31})^{32} \parallel \text{temp}$

Exceptions:

None

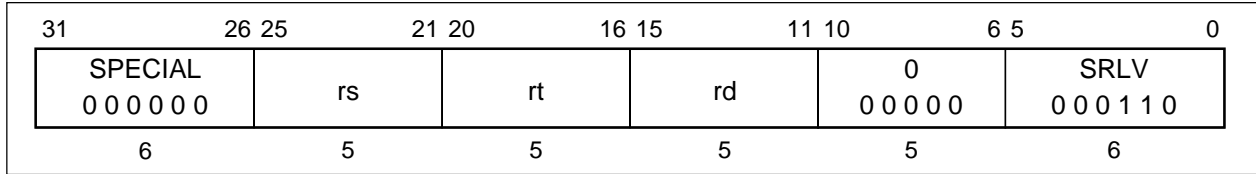
SRLV**Shift Right Logical Variable****SRLV****Format:**

SRLV rd, rt, rs

Description:

The contents of general register *rt* are shifted right by the number of bits specified by the low-order five bits of general register *rs*, inserting zeros into the high-order bits.

The result is placed in register *rd*.

In 64-bit mode, the operand must be a valid sign-extended, 32-bit value.

Operation:

32	T: $s \leftarrow \text{GPR}[rs]_{4..0}$ $\text{GPR}[rd] \leftarrow 0^s \parallel \text{GPR}[rt]_{31..s}$
64	T: $s \leftarrow \text{GPR}[rs]_{4..0}$ $\text{temp} \leftarrow 0^s \parallel \text{GPR}[rt]_{31..s}$ $\text{GPR}[rd] \leftarrow (\text{temp}_{31})^{32} \parallel \text{temp}$

Exceptions:

None

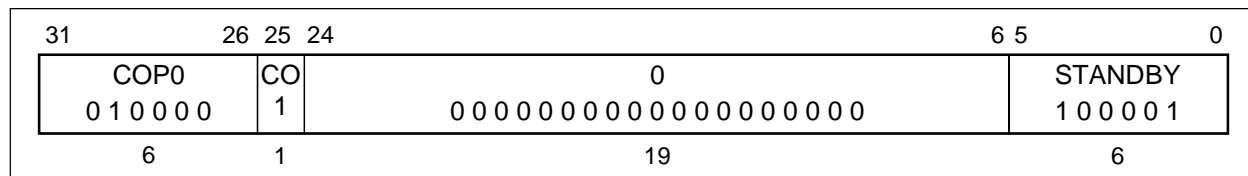
STANDBY**Standby****STANDBY****Format:**

STANDBY

Description:

STANDBY instruction starts mode transition from Fullspeed mode to Standby mode.

When the STANDBY instruction finishes the WB stage, the VR4181 wait by the SysAD bus is idle state, after then the internal clocks will shut down, thus freezing the pipeline. The PLL, Timer/Interrupt clocks and the internal bus clocks (TClock and MasterOut) will continue to run.

Once the VR4181 is in Standby mode, any interrupt, including the internally generated timer interrupt, NMI, Soft Reset, and Cold Reset will cause the VR4181 to exit Standby mode and to enter Fullspeed mode.

Operation:

32, 64 T:
T+1: Standby operation ()

Exceptions:

Coprocessor unusable exception

Remark Refer to Chapter 16 for details about the operation of the peripheral units at mode transition.

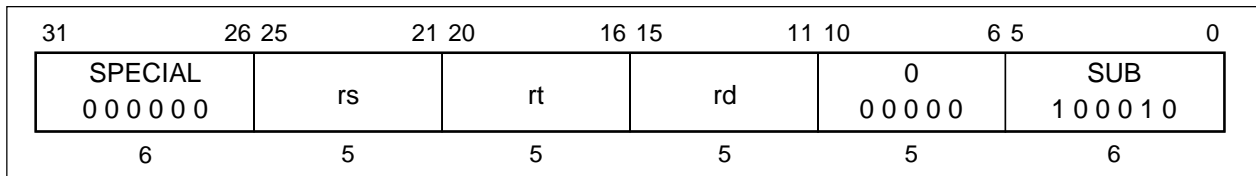
SUB**Subtract****SUB****Format:**

SUB rd, rs, rt

Description:

The contents of general register *rt* are subtracted from the contents of general register *rs* to form a result. The result is placed into general register *rd*. In 64-bit mode, the operands must be valid sign-extended, 32-bit values. The only difference between this instruction and the SUBU instruction is that SUBU never traps on overflow. An integer overflow exception takes place if the carries out of bits 30 and 31 differ (2's complement overflow). The destination register *rd* is not modified when an integer overflow exception occurs.

Operation:

32	T: GPR [rd] ← GPR [rs] – GPR [rt]
64	T: temp ← GPR [rs] – GPR [rt] GPR [rd] ← (temp ₃₁) ³² temp _{31...0}

Exceptions:

Integer overflow exception

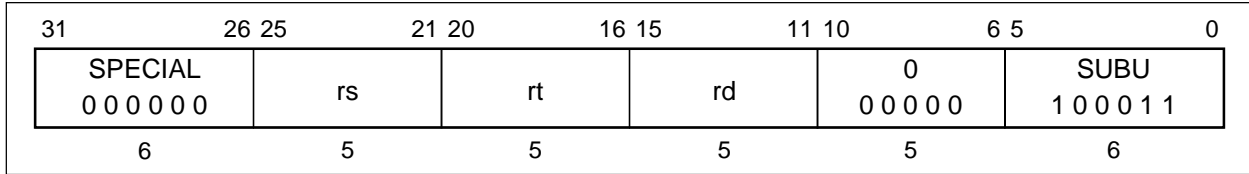
SUBU**Subtract Unsigned****SUBU****Format:**

SUBU rd, rs, rt

Description:

The contents of general register *rt* are subtracted from the contents of general register *rs* to form a result.

The result is placed into general register *rd*.

In 64-bit mode, the operands must be valid sign-extended, 32-bit values.

The only difference between this instruction and the SUB instruction is that SUBU never traps on overflow. No integer overflow exception occurs under any circumstances.

Operation:

32	T: $GPR[rd] \leftarrow GPR[rs] - GPR[rt]$
64	T: $temp \leftarrow GPR[rs] - GPR[rt]$ $GPR[rd] \leftarrow (temp_{31})^{32} temp_{31...0}$

Exceptions:

None

SUSPEND

Suspend

SUSPEND

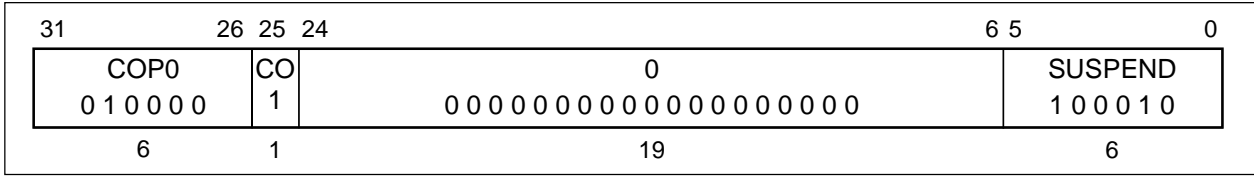

Format:

SUSPEND

Description:

SUSPEND instruction starts mode transition from Fullspeed mode to Suspend mode.

When the SUSPEND instruction finishes the WB stage, the V_R4181 wait by the SysAD bus is idle state, after then the internal clocks including the TClock will shut down, thus freezing the pipeline. The PLL, Timer/Interrupt clocks and MasterOut, will continue to run.

Once the V_R4181 is in Suspend mode, any interrupt, including the internally generated timer interrupt, NMI, Soft Reset and Cold Reset will cause the V_R4181 to exit Suspend mode and to enter Fullspeed mode.

Operation:

32, 64 T:
T+1: Suspend Operation ()

Exceptions:

Coprocessor unusable exception

Remark Refer to Chapter 16 for details about the operation of the peripheral units at mode transition.

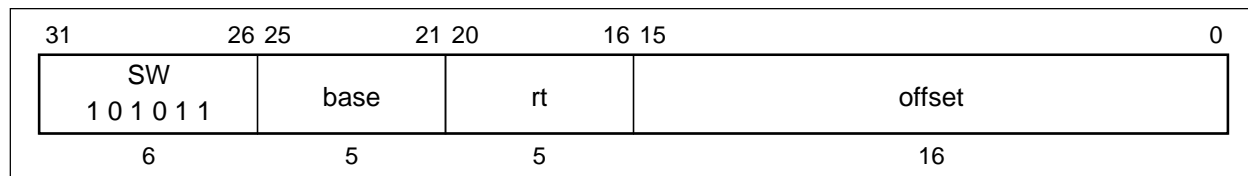
SW**Store Word****SW****Format:**

SW rt, offset (base)

Description:

The 16-bit *offset* is sign-extended and added to the contents of general register *base* to form a virtual address. The contents of general register *rt* are stored at the memory location specified by the effective address. If either of the two least-significant bits of the effective address are non-zero, an address error exception occurs.

Operation:

32	T:	$vAddr \leftarrow ((offset_{15})^{16} \parallel offset_{15...0}) + GPR [base]$ $(pAddr, uncached) \leftarrow AddressTranslation (vAddr, DATA)$ $pAddr \leftarrow pAddr_{PSIZE-1...3} \parallel (pAddr_{2...0} \text{ xor } (ReverseEndian \parallel 0^2))$ $byte \leftarrow vAddr_{2...0} \text{ xor } (BigEndianCPU \parallel 0^2)$ $data \leftarrow GPR [rt]_{63-8*byte...0} \parallel 0^{8*byte}$ StoreMemory (uncached, WORD, data, pAddr, vAddr, DATA)
64	T:	$vAddr \leftarrow ((offset_{15})^{48} \parallel offset_{15...0}) + GPR [base]$ $(pAddr, uncached) \leftarrow AddressTranslation (vAddr, DATA)$ $pAddr \leftarrow pAddr_{PSIZE-1...3} \parallel (pAddr_{2...0} \text{ xor } (ReverseEndian \parallel 0^2))$ $byte \leftarrow vAddr_{2...0} \text{ xor } (BigEndianCPU \parallel 0^2)$ $data \leftarrow GPR [rt]_{63-8*byte...0} \parallel 0^{8*byte}$ StoreMemory (uncached, WORD, data, pAddr, vAddr, DATA)

Exceptions:

- TLB refill exception
- TLB invalid exception
- TLB modification exception
- Bus error exception
- Address error exception

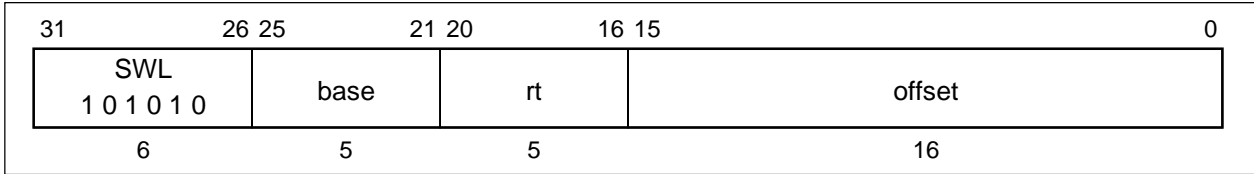
SWL**Store Word Left****SWL****Format:**

SWL rt, offset (base)

Description:

This instruction can be used with the SWR instruction to store the contents of a register into four consecutive bytes of memory, when the bytes cross a word boundary. SWL stores the left portion of the register into the appropriate part of the high-order word of memory; SWR stores the right portion of the register into the appropriate part of the low-order word.

The SWL instruction adds its sign-extended 16-bit *offset* to the contents of general register *base* to form a virtual address that may specify an arbitrary byte. It alters only the word in memory that contains that byte. From one to four bytes will be stored, depending on the starting byte specified.

Conceptually, it starts at the most-significant byte of the register and copies it to the specified byte in memory; then it copies bytes from register to memory until it reaches the low-order byte of the word in memory.

No address error exceptions due to alignment are possible.

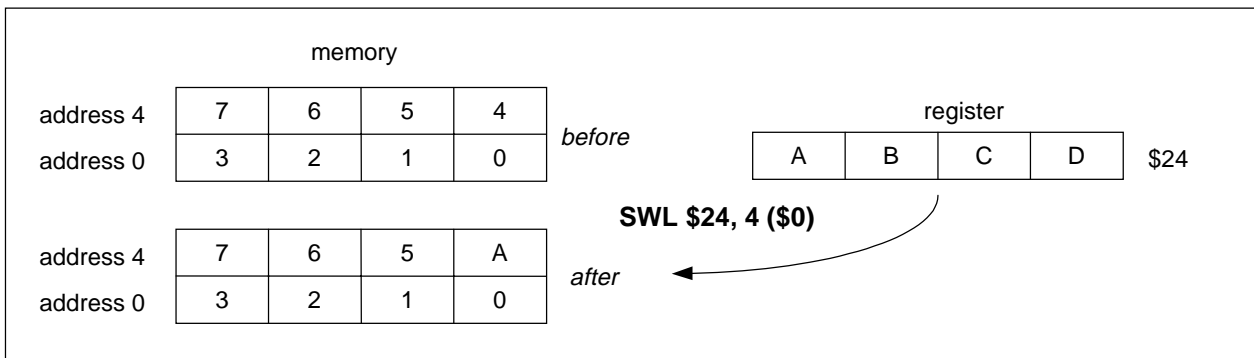

SWL

Store Word Left
(Continued)

SWL

Operation:

```

32    T:  vAddr ← ((offset15)16 || offset15...0) + GPR [base]
        (pAddr, uncached) ← AddressTranslation (vAddr, DATA)
        pAddr ← pAddrPSIZE - 1...3 || (pAddr2...0 xor ReverseEndian3)
        if BigEndianMem = 0 then
            pAddr ← pAddrPSIZE - 1...2 || 02
        endif
        byte ← vAddr1...0 xor BigEndianCPU2
        if (vAddr2 xor BigEndianCPU) = 0 then
            data ← 032 || 024 - 8*byte || GPR [rt]31...24 - 8*byte
        else
            data ← 024 - 8*byte || GPR [rt]31...24 - 8*byte || 032
        endif
        StoreMemory (uncached, byte, data, pAddr, vAddr, DATA)

64    T:  vAddr ← ((offset15)48 || offset15...0) + GPR [base]
        (pAddr, uncached) ← AddressTranslation (vAddr, DATA)
        pAddr ← pAddrPSIZE - 1...3 || (pAddr2...0 xor ReverseEndian3)
        if BigEndianMem = 1 then
            pAddr ← pAddrPSIZE - 1...2 || 02
        endif
        byte ← vAddr1...0 xor BigEndianCPU2
        if (vAddr2 xor BigEndianCPU) = 0 then
            data ← 032 || 024 - 8*byte || GPR [rt]31...24 - 8*byte
        else
            data ← 024 - 8*byte || GPR [rt]31...24 - 8*byte || 032
        endif
        StoreMemory (uncached, byte, data, pAddr, vAddr, DATA)

```

SWL**Store Word Left
(Continued)****SWL**

Given a doubleword in a register and a doubleword in memory, the operation of SWL is as follows:

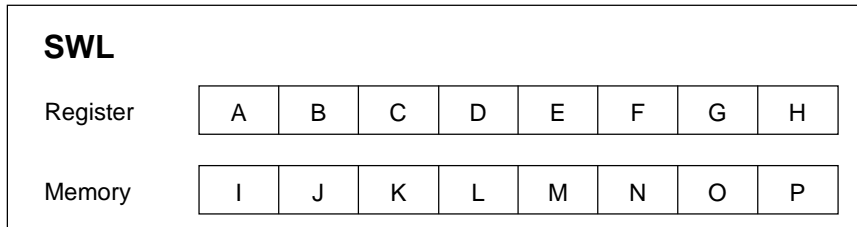

vAddr _{2..0}	BigEndianCPU = 0		
	destination	type	offset (LEM)
0	I J K L M N O E	0	0
1	I J K L M N E F	1	0
2	I J K L M E F G	2	0
3	I J K L E F G H	3	0
4	I J K E M N O P	0	4
5	I J E F M N O P	1	4
6	I E F G M N O P	2	4
7	E F G H M N O P	3	4

LEM Little-endian memory (BigEndianMem = 0)
Type AccessType (see **Figure 3-2**) sent to memory
Offset pAddr_{2..0} sent to memory

Exceptions:

- TLB refill exception
- TLB invalid exception
- TLB modification exception
- Bus error exception
- Address error exception

SWR Store Word Right SWR

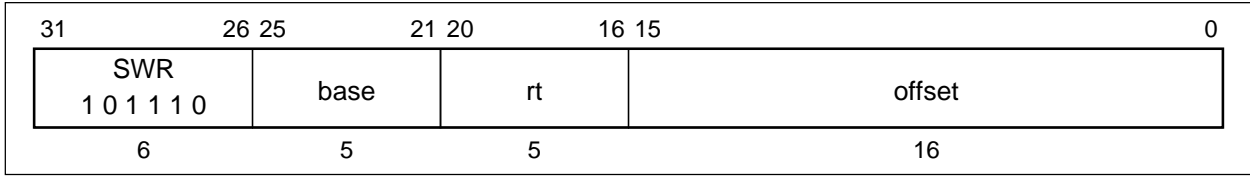

Format:

SWR rt, offset (base)

Description:

This instruction can be used with the SWL instruction to store the contents of a register into four consecutive bytes of memory, when the bytes cross a boundary between two words. SWR stores the right portion of the register into the appropriate part of the low-order word; SWL stores the left portion of the register into the appropriate part of the low-order word of memory.

The SWR instruction adds its sign-extended 16-bit *offset* to the contents of general register *base* to form a virtual address that may specify an arbitrary byte. It alters only the word in memory that contains that byte. From one to four bytes will be stored, depending on the starting byte specified.

Conceptually, it starts at the least-significant (rightmost) byte of the register and copies it to the specified byte in memory; then copies bytes from register to memory until it reaches the high-order byte of the word in memory.

No address error exceptions due to alignment are possible.

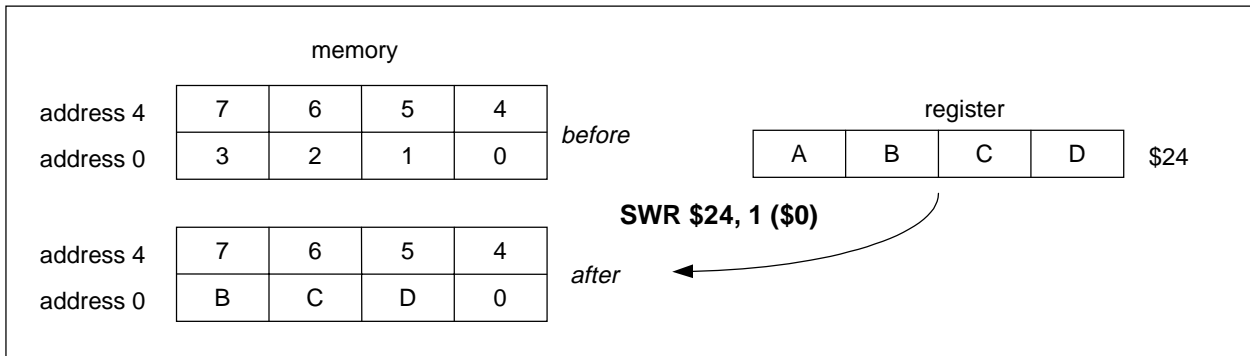

SWR**Store Word Right
(Continued)****SWR****Operation:**

```

32    T:  vAddr ← ((offset15)16 || offset15...0) + GPR [base]
        (pAddr, uncached) ← AddressTranslation (vAddr, DATA)
        pAddr ← pAddrPSIZE-1...3 || (pAddr2...0 xor ReverseEndian3)
        if BigEndianMem = 1 then
            pAddr ← pAddrPSIZE-1...2 || 02
        endif
        byte ← vAddr1...0 xor BigEndianCPU2
        if (vAddr2 xor BigEndianCPU) = 0 then
            data ← 032 || GPR [rt]31-8*byte...0 || 08*byte
        else
            data ← GPR [rt]31-8*byte || 08*byte || 032
        endif
        StoreMemory (uncached, WORD-byte, data, pAddr, vAddr, DATA)

64    T:  vAddr ← ((offset15)48 || offset15...0) + GPR [base]
        (pAddr, uncached) ← AddressTranslation (vAddr, DATA)
        pAddr ← pAddrPSIZE-1...3 || (pAddr2...0 xor ReverseEndian3)
        if BigEndianMem = 1 then
            pAddr ← pAddrPSIZE-1...2 || 02
        endif
        byte ← vAddr1...0 xor BigEndianCPU2
        if (vAddr2 xor BigEndianCPU) = 0 then
            data ← 032 || GPR [rt]31-8*byte...0 || 08*byte
        else
            data ← GPR [rt]31-8*byte || 08*byte || 032
        endif
        StoreMemory (uncached, WORD-byte, data, pAddr, vAddr, DATA)

```

SWR**Store Word Right
(Continued)****SWR**

Given a doubleword in a register and a doubleword in memory, the operation of SWR is as follows:

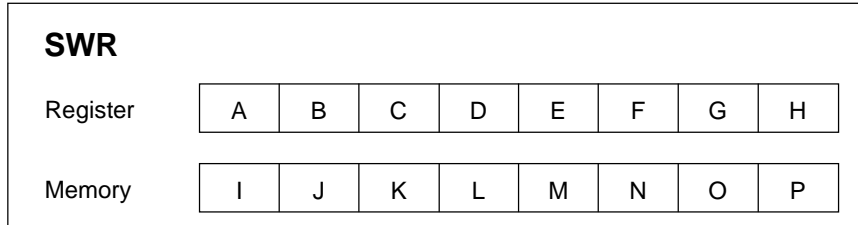

vAddr _{2..0}	BigEndianCPU = 0		
	destination	type	offset (LEM)
0	I J K L E F G H	3	0
1	I J K L F G H P	2	1
2	I J K L G H O P	1	2
3	I J K L H N O P	0	3
4	E F G H M N O P	3	4
5	F G H L M N O P	2	5
6	G H K L M N O P	1	6
7	H J K L M N O P	0	7

LEM Little-endian memory (BigEndianMem = 0)
Type AccessType (see **Figure 3-2**) sent to memory
Offset pAddr_{2..0} sent to memory

Exceptions:

- TLB refill exception
- TLB invalid exception
- TLB modification exception
- Bus error exception
- Address error exception

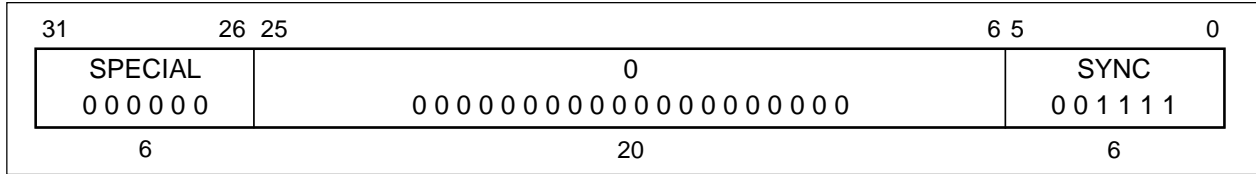
SYNC**Synchronize****SYNC****Format:**

SYNC

Description:

The SYNC instruction is executed as a NOP on the VR4181. This operation maintains compatibility with code compiled for the VR4100.

Operation:

32, 64 T: SyncOperation ()

Exceptions:

None

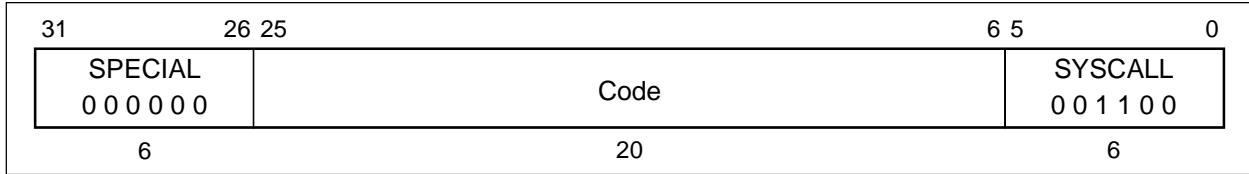
SYSCALL**System Call****SYSCALL****Format:**

SYSCALL

Description:

A system call exception occurs, immediately and unconditionally transferring control to the exception handler.

The code field is available for use as software parameters, but is retrieved by the exception handler only by loading the contents of the memory word containing the instruction.

Operation:

32, 64 T: SystemCallException

Exceptions:

System call exception

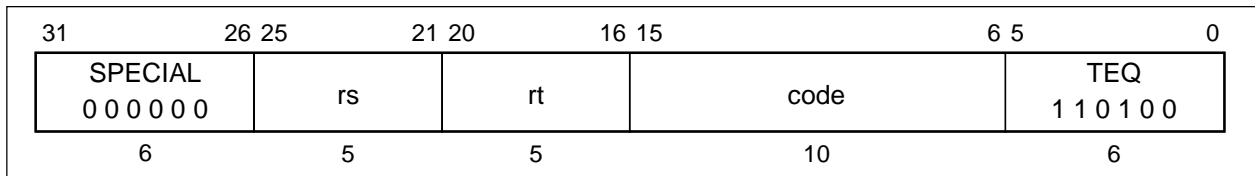
TEQ**Trap If Equal****TEQ****Format:**TEQ *rs*, *rt***Description:**

The contents of general register *rt* are compared to general register *rs*. If the contents of general register *rs* are equal to the contents of general register *rt*, a trap exception occurs.

The code field is available for use as software parameters, but is retrieved by the exception handler only by loading the contents of the memory word containing the instruction.

Operation:

```

32, 64 T:  if GPR [rs] = GPR [rt] then
            TrapException
            endif

```

Exceptions:

Trap exception

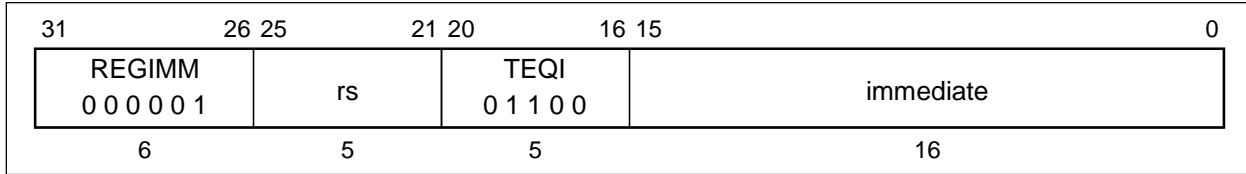
TEQI**Trap If Equal Immediate****TEQI****Format:**

TEQI rs, immediate

Description:

The 16-bit *immediate* is sign-extended and compared to the contents of general register *rs*. If the contents of general register *rs* are equal to the sign-extended *immediate*, a trap exception occurs.

Operation:

```

32    T:  if GPR [rs] = (immediate15)16 || immediate15...0 then
        TrapException
    endif

64    T:  if GPR [rs] = (immediate15)48 || immediate15...0 then
        TrapException
    endif

```

Exceptions:

Trap exception

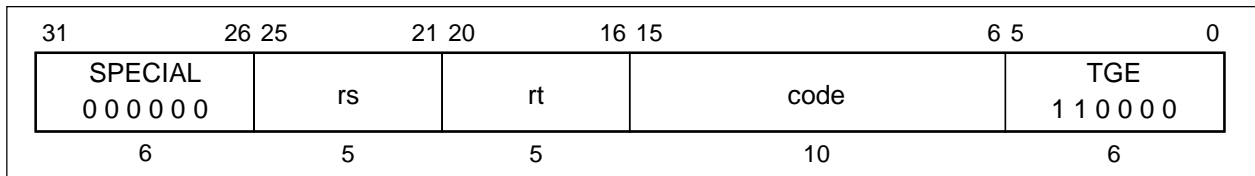
TGE**Trap If Greater Than or Equal****TGE****Format:**TGE *rs*, *rt***Description:**

The contents of general register *rt* are compared to the contents of general register *rs*. Considering both quantities as signed integers, if the contents of general register *rs* are greater than or equal to the contents of general register *rt*, a trap exception occurs.

The code field is available for use as software parameters, but is retrieved by the exception handler only by loading the contents of the memory word containing the instruction.

Operation:

```

32, 64 T:  if GPR [rs] ≥ GPR [rt] then
           TrapException
           endif

```

Exceptions:

Trap exception

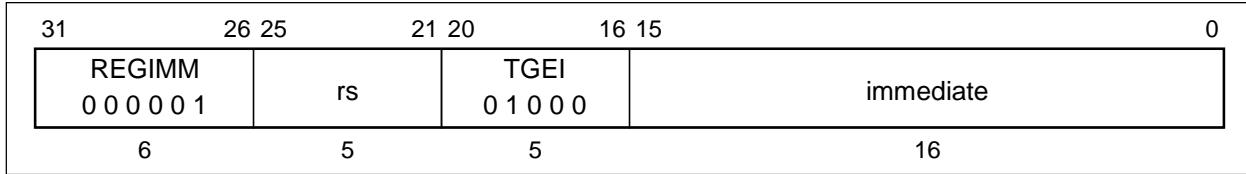
TGEI**Trap If Greater Than or Equal Immediate****TGEI****Format:**

TGEI rs, immediate

Description:

The 16-bit *immediate* is sign-extended and compared to the contents of general register *rs*. Considering both quantities as signed integers, if the contents of general register *rs* are greater than or equal to the sign-extended *immediate*, a trap exception occurs.

Operation:

```

32    T:  if GPR [rs] ≥ (immediate15)16 || immediate15...0 then
          TrapException
        endif

64    T:  if GPR [rs] ≥ (immediate15)48 || immediate15...0 then
          TrapException
        endif

```

Exceptions:

Trap exception

TGEU Trap If Greater Than or Equal Unsigned TGEU

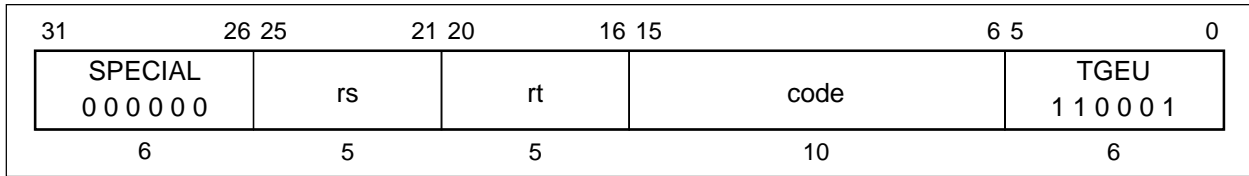
**Format:**

TGEU rs, rt

Description:

The contents of general register *rt* are compared to the contents of general register *rs*. Considering both quantities as unsigned integers, if the contents of general register *rs* are greater than or equal to the contents of general register *rt*, a trap exception occurs.

The code field is available for use as software parameters, but is retrieved by the exception handler only by loading the contents of the memory word containing the instruction.

Operation:

```
32, 64 T:  if (0 || GPR [rs]) ≥ (0 || GPR [rt]) then
           TrapException
           endif
```

Exceptions:

Trap exception

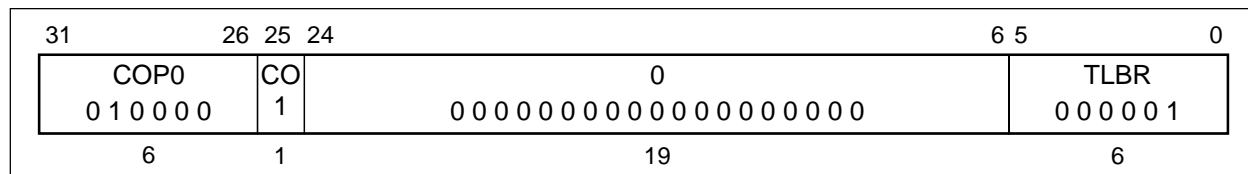
TLBR**Read Indexed TLB Entry****TLBR****Format:**

TLBR

Description:

The EntryHi and EntryLo registers are loaded with the contents of the TLB entry pointed at by the contents of the TLB Index register.

The G bit (which controls ASID matching) read from the TLB is written into both of the EntryLo0 and EntryLo1 registers. The operation is invalid (and the results are unspecified) if the contents of the TLB Index register are greater than the number of TLB entries in the processor.

Operation:

32	T: PageMask \leftarrow TLB [Index5...0] _{127...96} EntryHi \leftarrow TLB [Index5...0] _{95...64} and not TLB [Index5...0] _{127...96} EntryLo1 \leftarrow TLB [Index5...0] _{63...33} TLB [Index5...0] ₇₆ EntryLo0 \leftarrow TLB [Index5...0] _{31...1} TLB [Index5...0] ₇₆
64	T: PageMask \leftarrow TLB [Index5...0] _{255...192} EntryHi \leftarrow TLB [Index5...0] _{191...128} and not TLB [Index5...0] _{255...192} EntryLo1 \leftarrow TLB [Index5...0] _{127...65} TLB [Index5...0] ₁₄₀ EntryLo0 \leftarrow TLB [Index5...0] _{63...1} TLB [Index5...0] ₁₄₀

Exceptions:

Coprocessor unusable exception

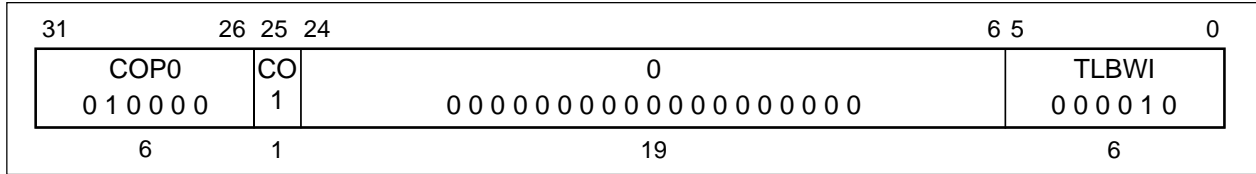
TLBWI**Write Indexed TLB Entry****TLBWI****Format:**

TLBWI

Description:

The TLB entry pointed at by the contents of the TLB Index register is loaded with the contents of the EntryHi and EntryLo registers.

The *G* bit of the TLB is written with the logical AND of the *G* bits in the EntryLo0 and EntryLo1 registers.

The operation is invalid (and the results are unspecified) if the contents of the TLB Index register are greater than the number of TLB entries in the processor.

Operation:

32, 64 T: TLB [Index_{s...0}] ←
PageMask || (EntryHi and not PageMask) || EntryLo1 || EntryLo0

Exceptions:

Coprocessor unusable exception

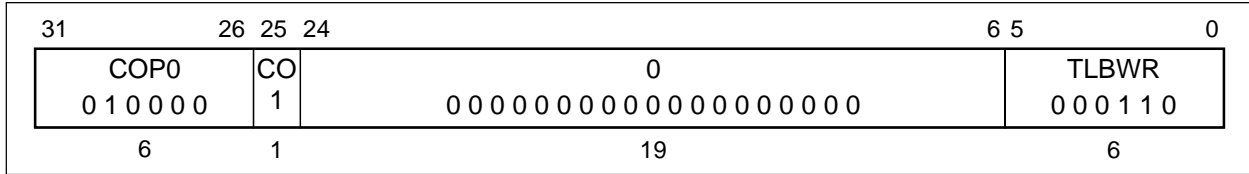
TLBWR**Write Random TLB Entry****TLBWR****Format:**

TLBWR

Description:

The TLB entry pointed at by the contents of the TLB Random register is loaded with the contents of the EntryHi and EntryLo registers.

The G bit of the TLB is written with the logical AND of the G bits in the EntryLo0 and EntryLo1 registers.

Operation:

32, 64 T: TLB [Random5..0] ←
PageMask || (EntryHi and not PageMask) || EntryLo1 || EntryLo0

Exceptions:

Coprocessor unusable exception

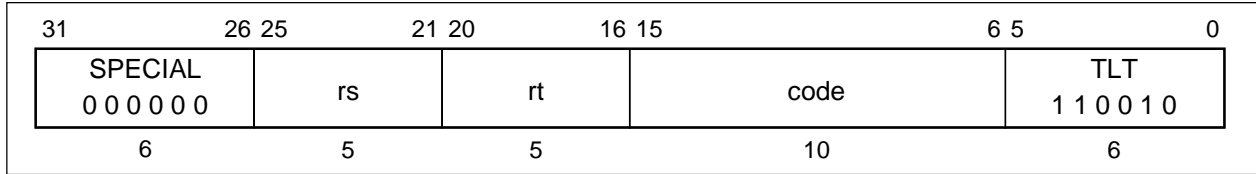
TLT**Trap If Less Than****TLT****Format:**TLT *rs*, *rt***Description:**

The contents of general register *rt* are compared to general register *rs*. Considering both quantities as signed integers, if the contents of general register *rs* are less than the contents of general register *rt*, a trap exception occurs.

The code field is available for use as software parameters, but is retrieved by the exception handler only by loading the contents of the memory word containing the instruction.

Operation:

```

32, 64 T:  if GPR [rs] < GPR [rt] then
           TrapException
           endif

```

Exceptions:

Trap exception

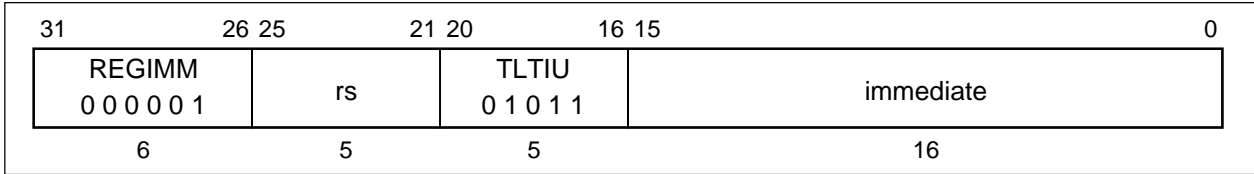
TLTIU**Trap If Than Immediate Unsigned****TLTIU****Format:**

TLTIU rs, immediate

Description:

The 16-bit *immediate* is sign-extended and compared to the contents of general register *rs*. Considering both quantities as unsigned integers, if the contents of general register *rs* are less than the sign-extended *immediate*, a trap exception occurs.

Operation:

```

32      T:  if (0 || GPR [rs]) < (0 || (immediate15)16 || immediate15...0) then
           TrapException
           endif

64      T:  if (0 || GPR [rs]) < (0 || (immediate15)48 || immediate15...0) then
           TrapException
           endif

```

Exceptions:

Trap exception

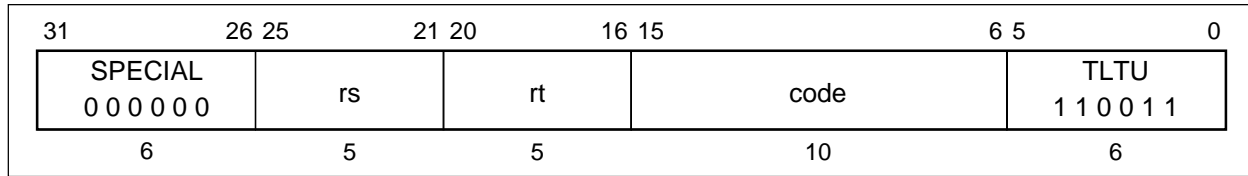
TLTU**Trap If Less Than Unsigned****TLTU****Format:**TLTU *rs*, *rt***Description:**

The contents of general register *rt* are compared to general register *rs*. Considering both quantities as unsigned integers, if the contents of general register *rs* are less than the contents of general register *rt*, a trap exception occurs.

The code field is available for use as software parameters, but is retrieved by the exception handler only by loading the contents of the memory word containing the instruction.

Operation:

```

32, 64 T:  if (0 || GPR [rs] < (0 || GPR [rt]) then
            TrapException
            endif

```

Exceptions:

Trap exception

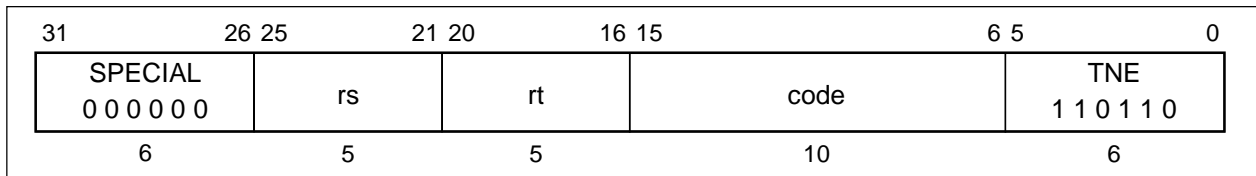
TNE**Trap If Not Equal****TNE****Format:**TNE *rs*, *rt***Description:**

The contents of general register *rt* are compared to general register *rs*. If the contents of general register *rs* are not equal to the contents of general register *rt*, a trap exception occurs.

The code field is available for use as software parameters, but is retrieved by the exception handler only by loading the contents of the memory word containing the instruction.

Operation:

```

32, 64 T:  if GPR [rs] ≠ GPR [rt] then
           TrapException
           endif

```

Exceptions:

Trap exception

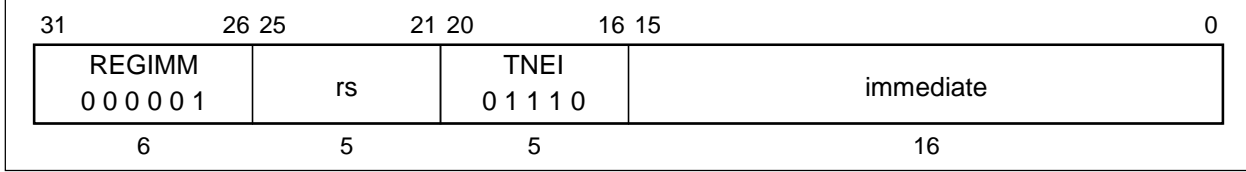
TNEI**Trap If Not Equal Immediate****TNEI****Format:**

TNEI rs, immediate

Description:

The 16-bit *immediate* is sign-extended and compared to the contents of general register *rs*. If the contents of general register *rs* are not equal to the sign-extended *immediate*, a trap exception occurs.

Operation:

```

32    T:  if GPR [rs] ≠ (immediate15)16 || immediate15...0 then
        TrapException
    endif

64    T:  if GPR [rs] ≠ (immediate15)48 || immediate15...0 then
        TrapException
    endif

```

Exceptions:

Trap exception

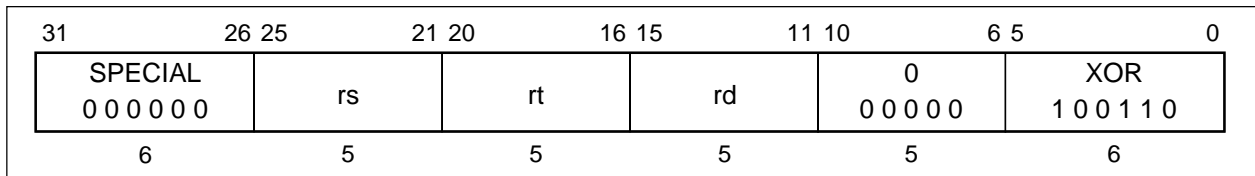
XOR**Exclusive OR****XOR****Format:**

XOR rd, rs, rt

Description:

The contents of general register *rs* are combined with the contents of general register *rt* in a bit-wise logical exclusive OR operation.

The result is placed into general register *rd*.

Operation:

$$32, 64 \text{ T: } \text{GPR [rd]} \leftarrow \text{GPR [rs]} \text{ xor GPR [rt]}$$
Exceptions:

None

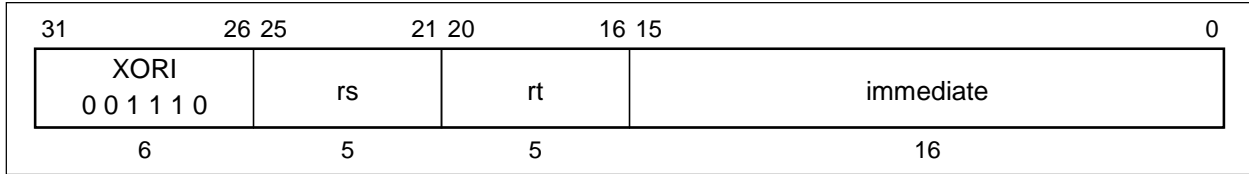
XORI**Exclusive OR Immediate****XORI****Format:**XORI *rt*, *rs*, *immediate***Description:**

The 16-bit *immediate* is zero-extended and combined with the contents of general register *rs* in a bit-wise logical exclusive OR operation.

The result is placed into general register *rt*.

Operation:

32 T: $\text{GPR}[\text{rt}] \leftarrow \text{GPR}[\text{rs}] \text{ xor } (0^{16} \parallel \text{immediate})$

64 T: $\text{GPR}[\text{rt}] \leftarrow \text{GPR}[\text{rs}] \text{ xor } (0^{48} \parallel \text{immediate})$

Exceptions:

None

27.6 CPU Instruction Opcode Bit Encoding

The remainder of this chapter presents the opcode bit encoding for the CPU instruction set (ISA and extensions), as implemented by the Vr4181. Figure 27-1 lists the Vr4181 Opcode Bit Encoding.

Figure 27-1. Vr4181 Opcode Bit Encoding (1/2)

28...26		Opcode							
31...29	0	1	2	3	4	5	6	7	
0	SPECIAL	REGIMM	J	JAL	BEQ	BNE	BLEZ	BGTZ	
1	ADDI	ADDIU	SLTI	SLTIU	ANDI	ORI	XORI	LUI	
2	COP0	π	π	*	BEQL	BNEL	BLEZL	BGTZL	
3	DADDI ϵ	DADDIU ϵ	LDL ϵ	LDR ϵ	*	JALX θ	*	*	
4	LB	LH	LWL	LW	LBU	LHU	LWR	LWU ϵ	
5	SB	SH	SWL	SW	SDL ϵ	SDR ϵ	SWR	CACHE δ	
6	*	π	π	*	*	π	π	LD ϵ	
7	*	π	π	*	*	π	π	SD ϵ	

2...0		SPECIAL function							
5...3	0	1	2	3	4	5	6	7	
0	SLL	*	SRL	SRA	SLLV	*	SRLV	SRAV	
1	JR	JALR	*	*	SYSCALL	BREAK	*	SYNC	
2	MFHI	MTHI	MFLO	MTLO	DSLLV ϵ	*	DSRLV ϵ	DSRAV ϵ	
3	MULT	MULTU	DIV	DIVU	DMULT ϵ	DMULTU ϵ	DDIV ϵ	DDIVU ϵ	
4	ADD	ADDU	SUB	SUBU	AND	OR	XOR	NOR	
5	MADD16	DMADD16	SLT	SLTU	DADD ϵ	DADDU ϵ	DSUB ϵ	DSUBU ϵ	
6	TGE	TGEU	TLT	TLTU	TEQ	*	TNE	*	
7	DSLL ϵ	*	DSRL ϵ	DSRA ϵ	DSLL32 ϵ	*	DSRL32 ϵ	DSRA32 ϵ	

18...16		REGIMM rt							
20...19	0	1	2	3	4	5	6	7	
0	BLTZ	BGEZ	BLTZL	BGEZL	*	*	*	*	
1	TGEI	TGEIU	TLTI	TLTIU	TEQI	*	TNEI	*	
2	BLTZAL	BGEZAL	BLTZALL	BGEZALL	*	*	*	*	
3	*	*	*	*	*	*	*	*	

Figure 27-1. V_R4181 Opcode Bit Encoding (2/2)

23...21		COP0 rs							
25, 24	0	1	2	3	4	5	6	7	
0	MF	DMF ϵ	γ	γ	MT	DMT ϵ	γ	γ	
1	BC	γ	γ	γ	γ	γ	γ	γ	
2	CO								
3									

18...16		COP0 rt							
20...19	0	1	2	3	4	5	6	7	
0	BCF	BCT	BCFL	BCTL	γ	γ	γ	γ	
1	γ	γ	γ	γ	γ	γ	γ	γ	
2	γ	γ	γ	γ	γ	γ	γ	γ	
3	γ	γ	γ	γ	γ	γ	γ	γ	

2...0		CPO Function							
5...3	0	1	2	3	4	5	6	7	
0	ϕ	TLBR	TLBWI	ϕ	ϕ	ϕ	TLBWR	ϕ	
1	TLBP	ϕ	ϕ	ϕ	ϕ	ϕ	ϕ	ϕ	
2	ξ	ϕ	ϕ	ϕ	ϕ	ϕ	ϕ	ϕ	
3	ERET χ	ϕ	ϕ	ϕ	ϕ	ϕ	ϕ	ϕ	
4	ϕ	STANDBY	SUSPEND	HIBERNATE	ϕ	ϕ	ϕ	ϕ	
5	ϕ	ϕ	ϕ	ϕ	ϕ	ϕ	ϕ	ϕ	
6	ϕ	ϕ	ϕ	ϕ	ϕ	ϕ	ϕ	ϕ	
7	ϕ	ϕ	ϕ	ϕ	ϕ	ϕ	ϕ	ϕ	

Key:

- * Operation codes marked with an asterisk cause reserved instruction exceptions in all current implementations and are reserved for future versions of the architecture.
- γ Operation codes marked with a gamma cause a reserved instruction exception. They are reserved for future versions of the architecture.
- δ Operation codes marked with a delta are valid only for V_R4400 Series processors with CP0 enabled, and cause a reserved instruction exception on other processors.
- ϕ Operation codes marked with a phi are invalid but do not cause reserved instruction exceptions in V_R4181 implementations.
- ξ Operation codes marked with a xi cause a reserved instruction exception on V_R4181 processor.
- χ Operation codes marked with a chi are valid on V_R4000 Series only.
- ϵ Operation codes marked with epsilon are valid when the processor operating as a 64-bit processor. These instructions will cause a reserved instruction exception if 64-bit operation is not enabled. Operation codes marked with a pi are invalid and cause coprocessor unusable exception.
- θ Operation codes marked with a theta are valid when MIPS16 instruction execution is enabled, and cause a reserved instruction exception when MIPS16 instruction execution is disabled.

CHAPTER 28 MIPS16 INSTRUCTION SET FORMAT

This chapter describes the format of each MIPS16 instruction, and the format of the MIPS instructions that are made by converting MIPS16 instructions in alphabetical order. For details of MIPS16 instruction conversion and opcode, refer to **CHAPTER 4 MIPS16 INSTRUCTION SET**.

Caution For some instructions, their format or syntax may become ineffective after they are converted to a 32-bit instruction. For details of formats and syntax of 32-bit instructions, refer to **CHAPTER 3 MIPS III INSTRUCTION SET SUMMARY** and **CHAPTER 27 MIPS III INSTRUCTION SET DETAILS**.

ADDIU

Add Immediate Unsigned

(1/2)

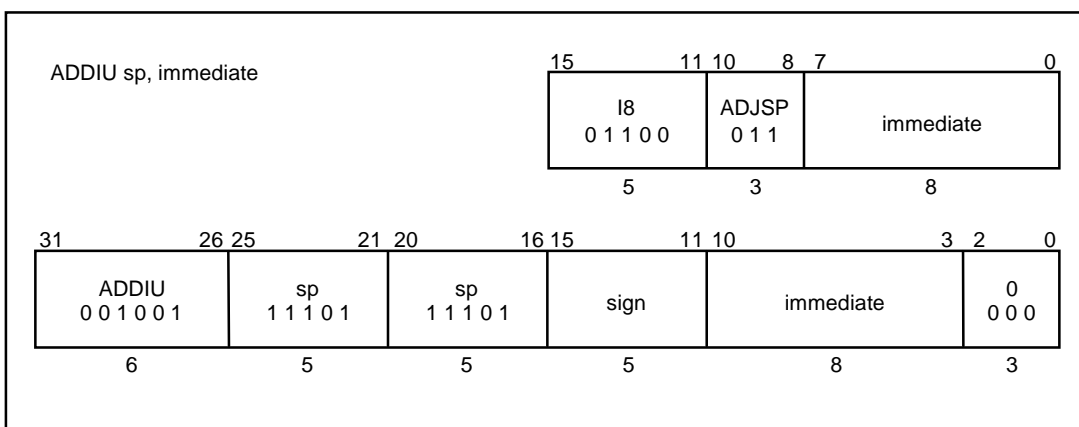
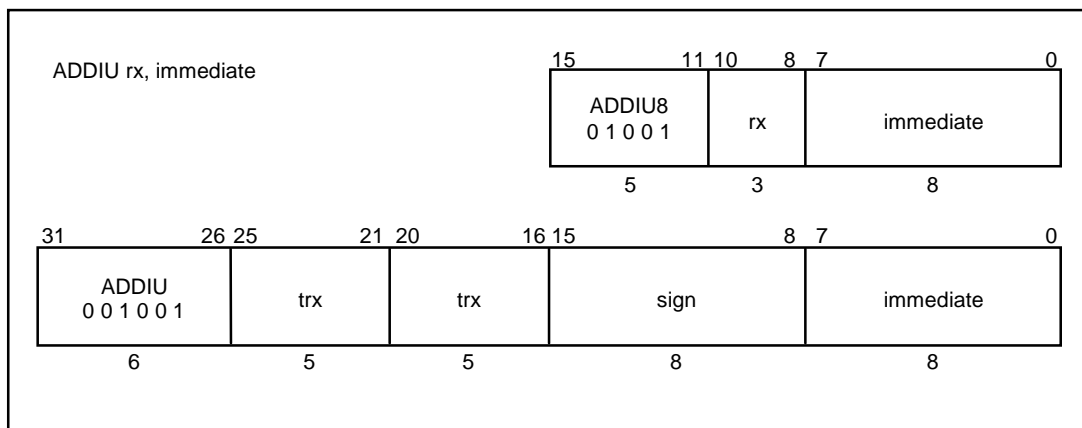
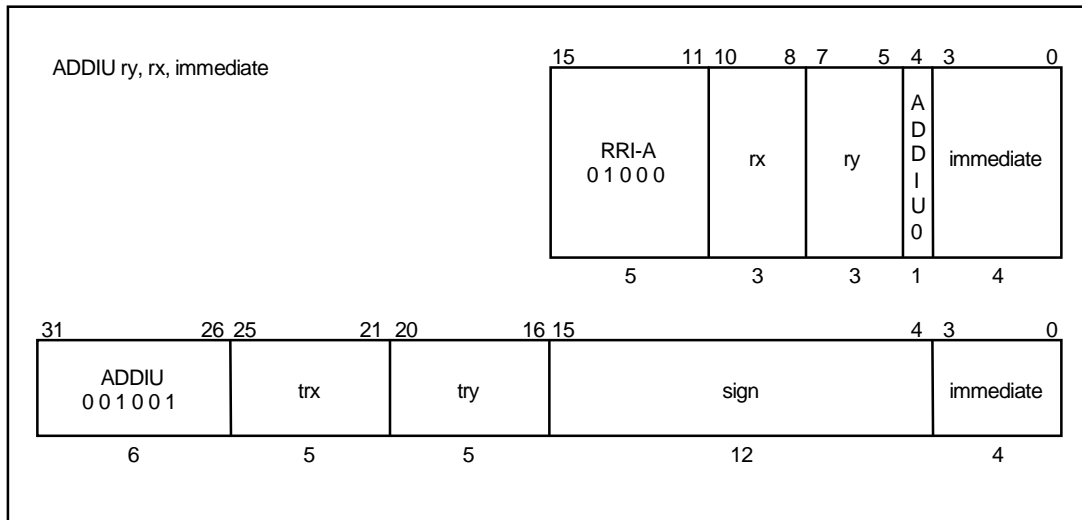

ADDIU

Add Immediate Unsigned

(2/2)

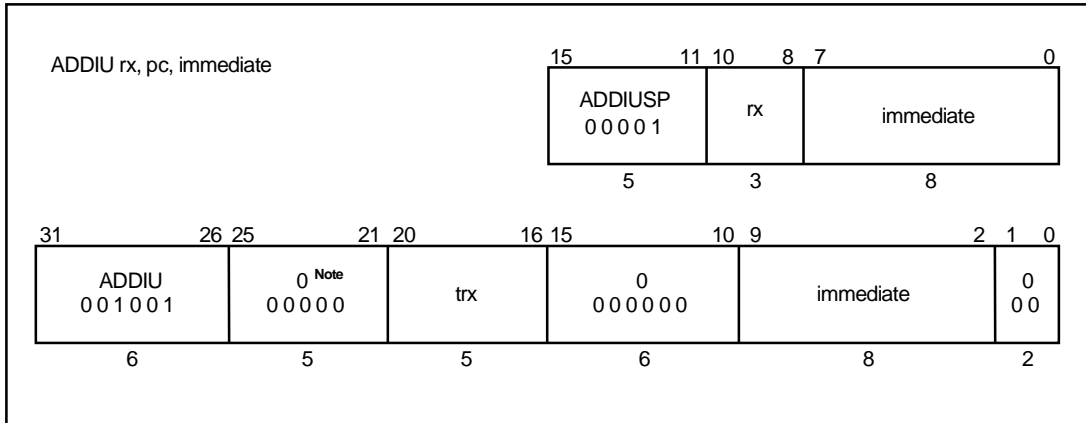

Note Zeros are shown in the field of bits 21 to 25 as placeholders. The 32-bit PC-relative instruction format shown above is provided here only to make the description complete; it is not a valid 32-bit MIPS instruction. Please see Chapter 4 for a complete definition of the semantics of the MIPS16 PC-relative instructions.

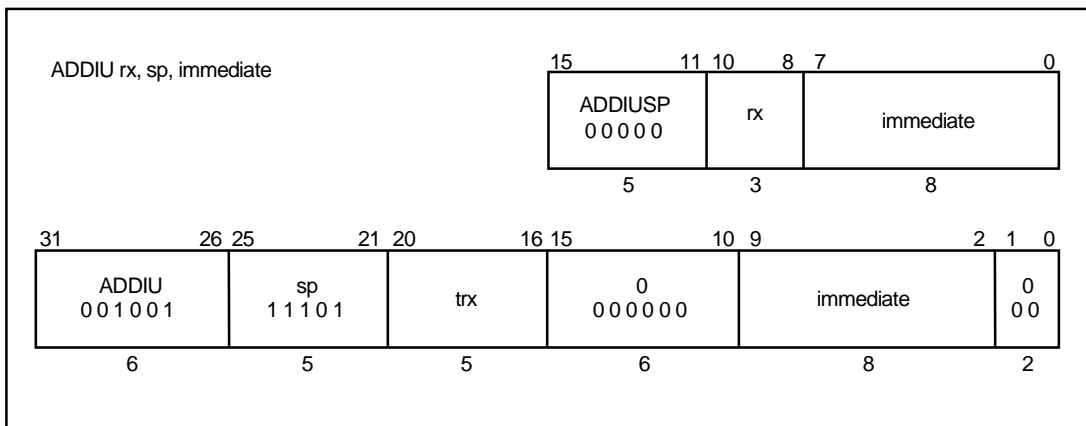

ADDU

Add Unsigned

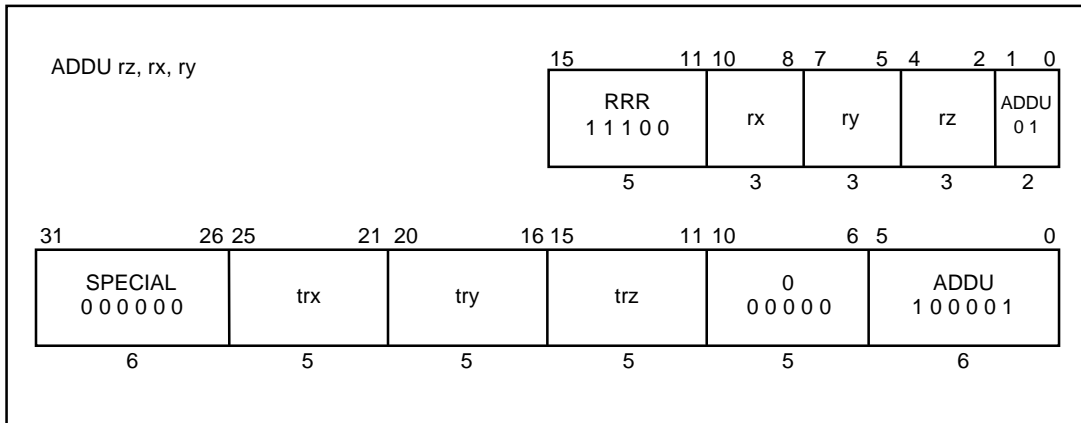

AND

AND

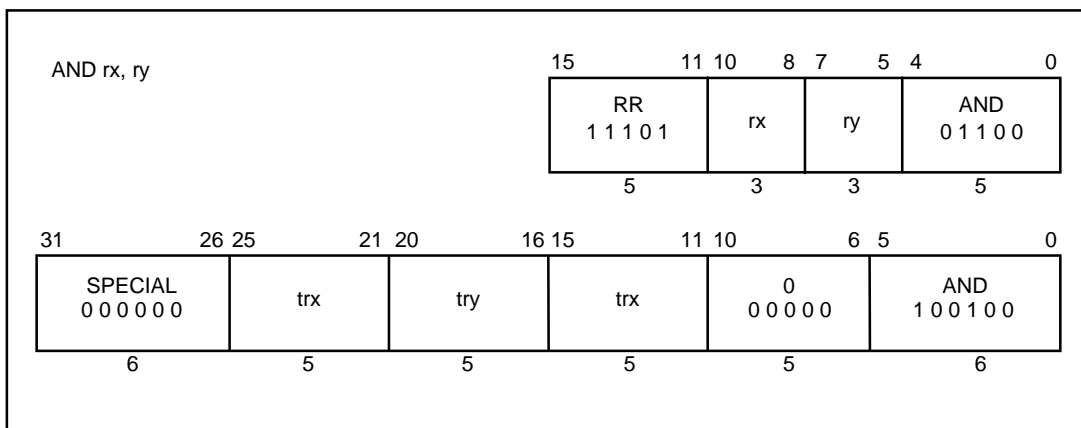

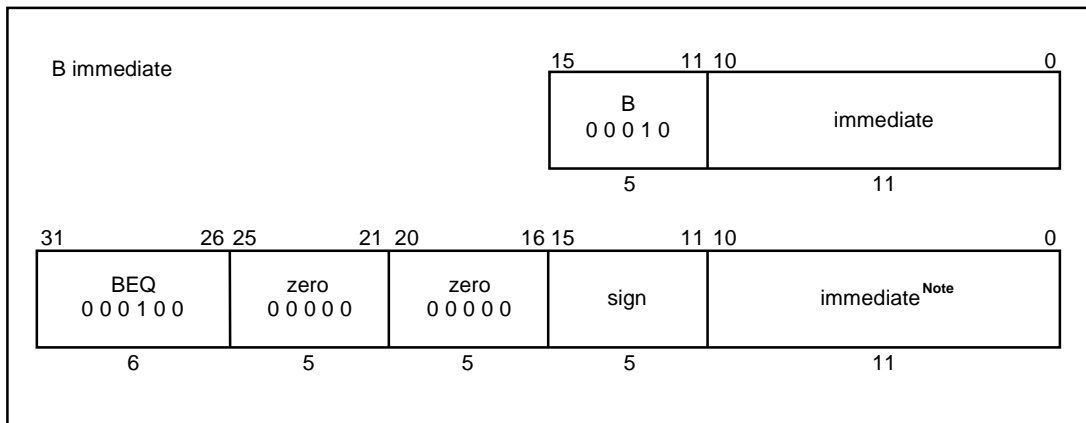
B**Branch Unconditional**

Note In MIPS16 mode, the branch offset is interpreted as halfword aligned. This is unlike 32-bit MIPS mode which interprets the offset value as word aligned. The 32-bit branch instruction format shown above is provided here only to make the description complete; it is not a valid 32-bit MIPS instruction. Please see Chapter 3 and Chapter 27 for a complete definition of the semantics of the MIPS16 branch instructions.

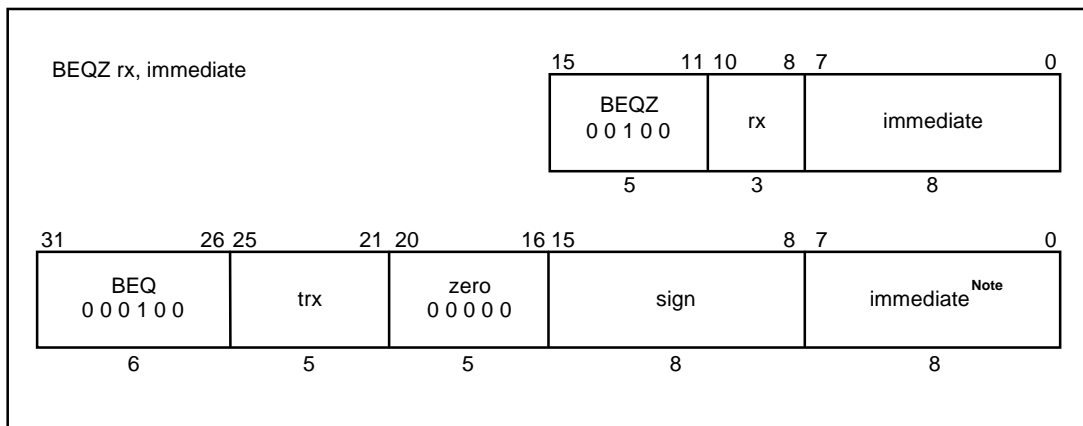
BEQZ**Branch On Equal to Zero**

Note In MIPS16 mode, the branch offset is interpreted as halfword aligned. This is unlike 32-bit MIPS mode which interprets the offset value as word aligned. The 32-bit branch instruction format shown above is provided here only to make the description complete; it is not a valid 32-bit MIPS instruction. Please see Chapter 3 and Chapter 27 for a complete definition of the semantics of the MIPS16 branch instructions.

BNEZ

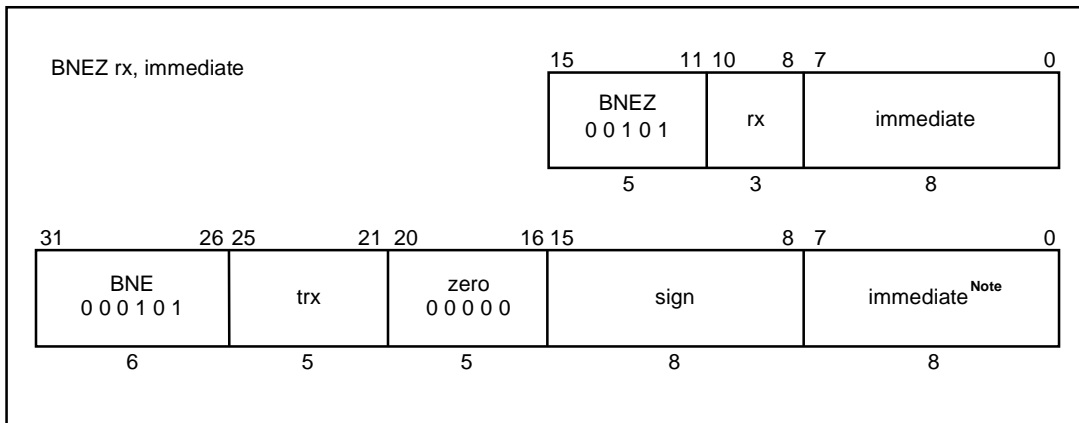
Branch Not Equal to Zero

Note In MIPS16 mode, the branch offset is interpreted as halfword aligned. This is unlike 32-bit MIPS mode which interprets the offset value as word aligned. The 32-bit branch instruction format shown above is provided here only to make the description complete; it is not a valid 32-bit MIPS instruction. Please see Chapter 3 and Chapter 27 for a complete definition of the semantics of the MIPS16 branch instructions.

BREAK

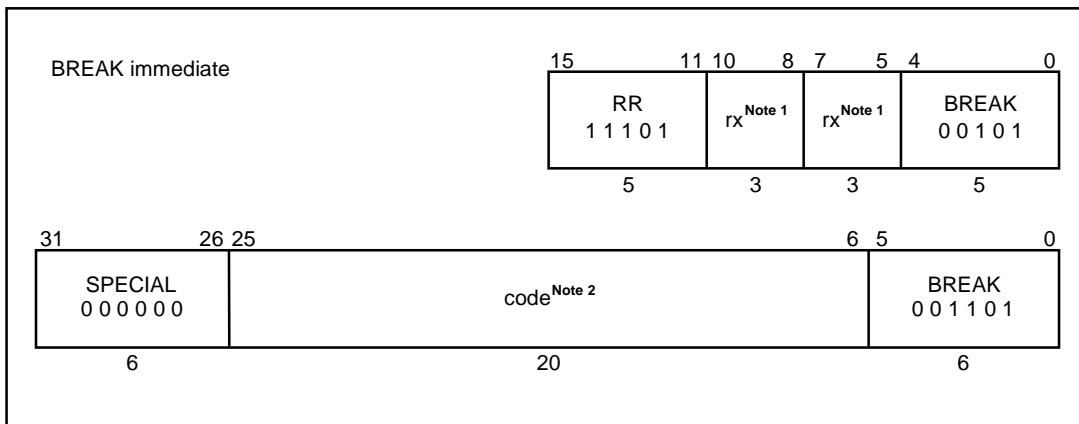
Breakpoint

- Notes 1.** The two register fields in the MIPS16 break instruction may be used as a 6-bit code (immediate) field for software parameters. The 6-bit code can be retrieved by the exception handler.
- 2.** The 32-bit break instruction format shown above is provided here only to make the description complete; it is not a valid 32-bit MIPS instruction. The code field is entirely ignored by the pipeline, and it is not visible in any way to the software executing on the processor.

BTEQZ

Branch On T Equal to Zero

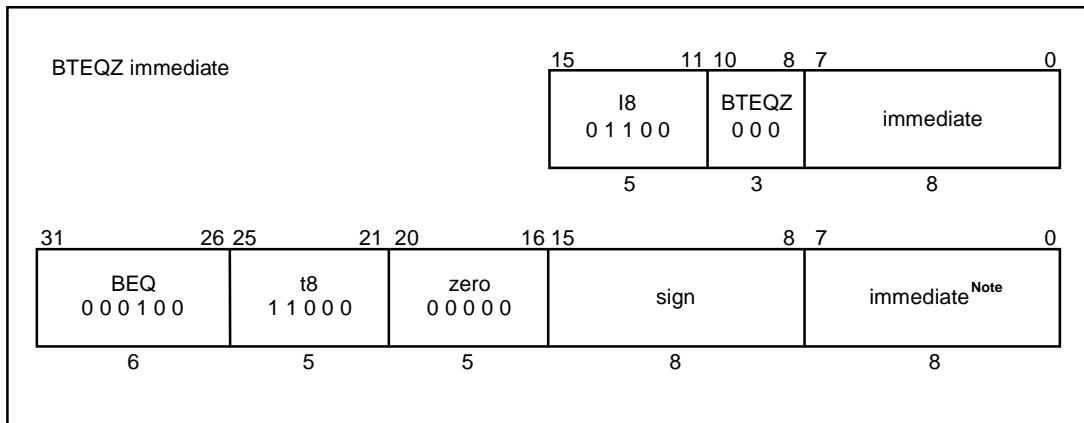

Note In MIPS16 mode, the branch offset is interpreted as halfword aligned. This is unlike 32-bit MIPS mode which interprets the offset value as word aligned. The 32-bit branch instruction format shown above is provided here only to make the description complete; it is not a valid 32-bit MIPS instruction. Please see Chapter 3 and Chapter 27 for a complete definition of the semantics of the MIPS16 branch instructions.

BTNEZ

Branch On T Not Equal to Zero

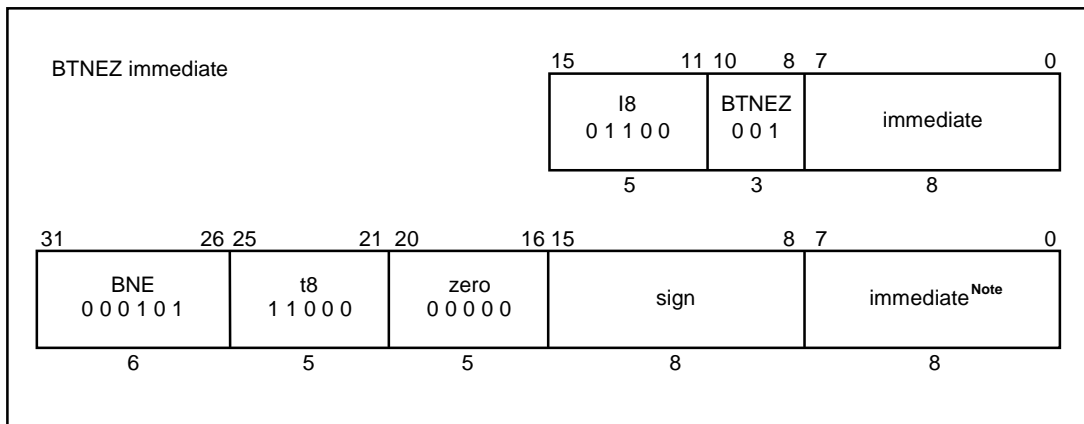

Note In MIPS16 mode, the branch offset is interpreted as halfword aligned. This is unlike 32-bit MIPS mode which interprets the offset value as word aligned. The 32-bit branch instruction format shown above is provided here only to make the description complete; it is not a valid 32-bit MIPS instruction. Please see Chapter 3 and Chapter 27 for a complete definition of the semantics of the MIPS16 branch instructions.

CMP

Compare

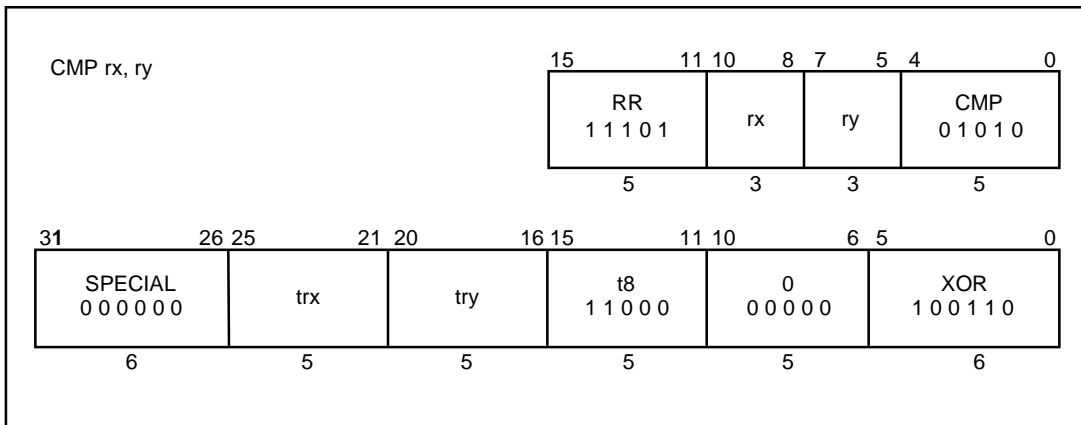

CMPI

Compare Immediate

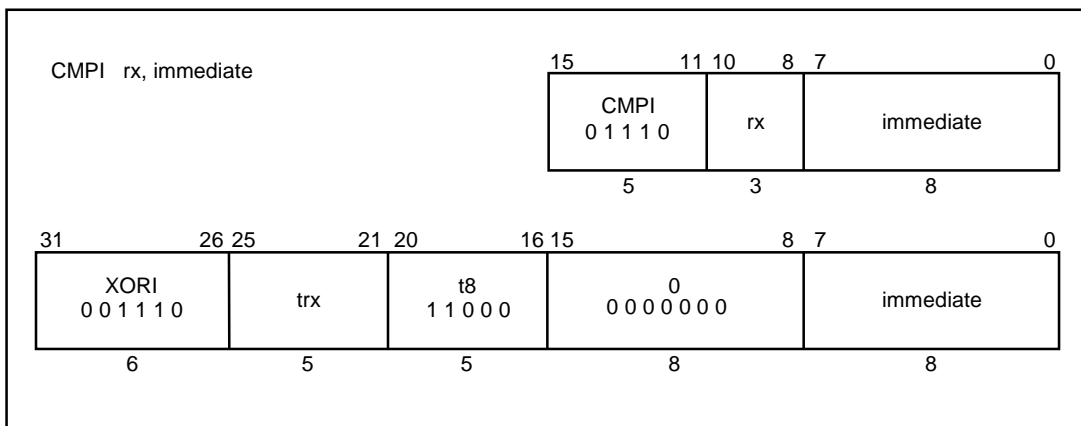

DADDIU

Doubleword Add Immediate Unsigned

(1/2)

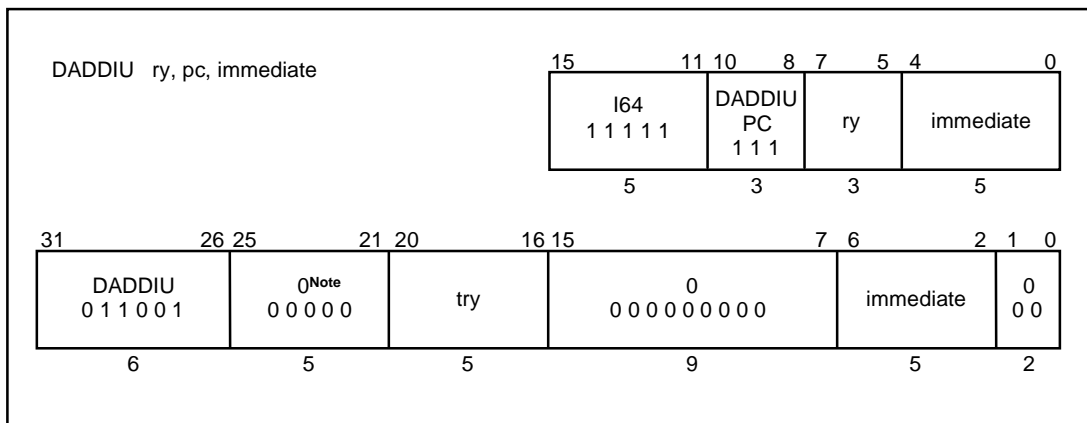
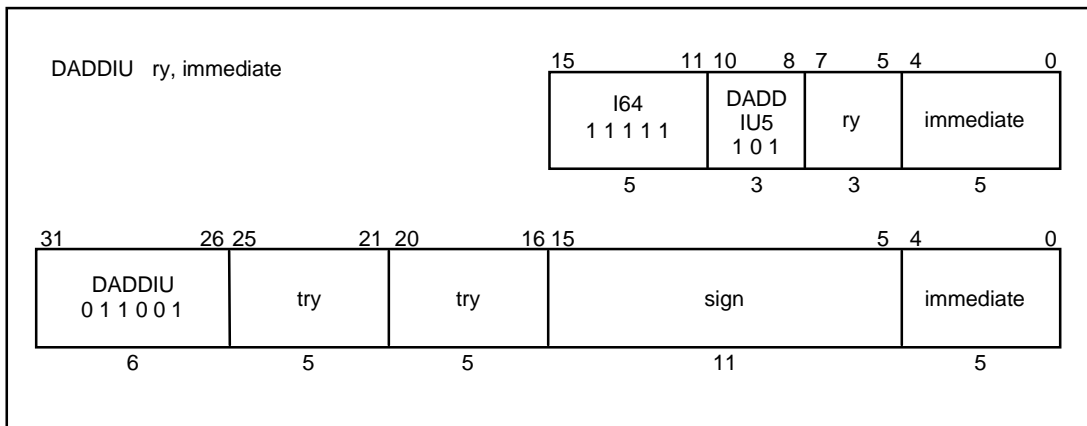
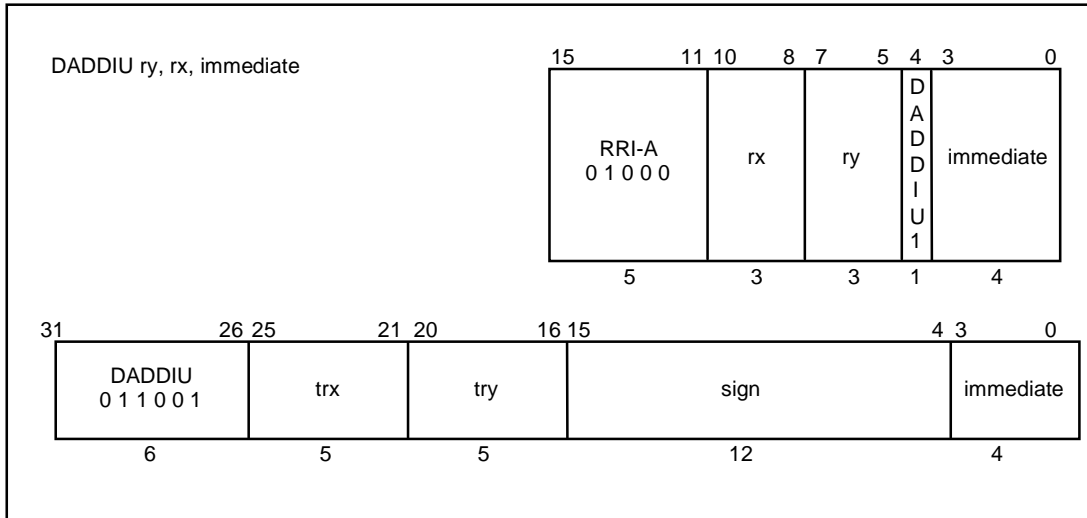

Note Zeros are shown in the field of bits 21 to 25 as placeholders. The 32-bit PC-relative instruction format shown above is provided here only to make the description complete; it is not a valid 32-bit MIPS instruction. Please see Chapter 4 for a complete definition of the semantics of the MIPS16 PC-relative instructions.

DADDIU

Doubleword Add Immediate Unsigned

(2/2)

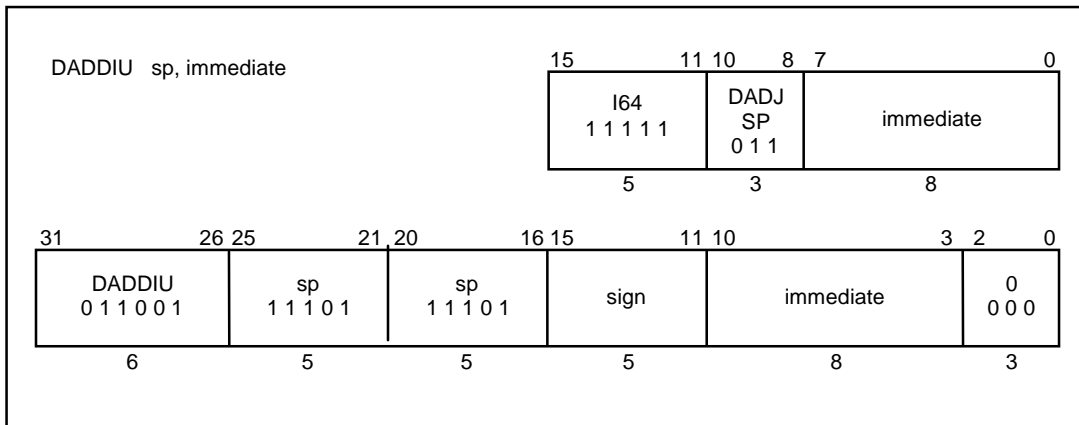
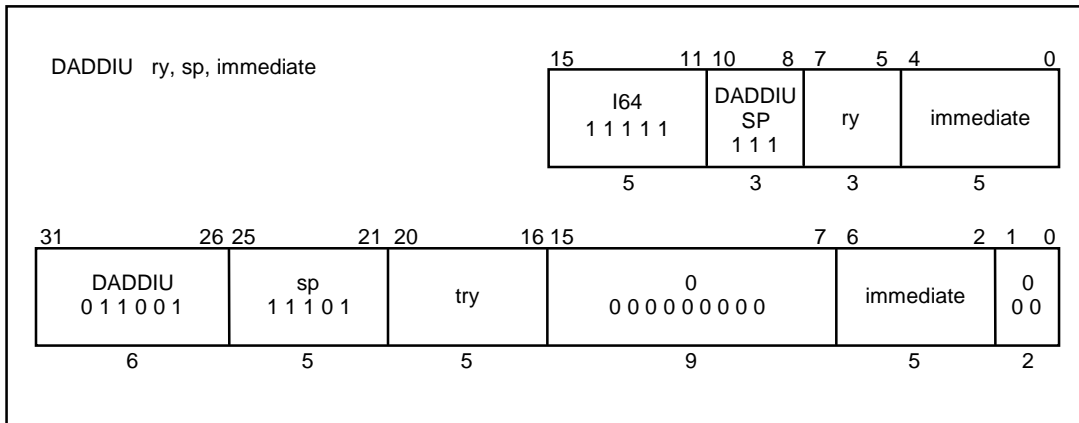

DADDU

Doubleword Add Unsigned

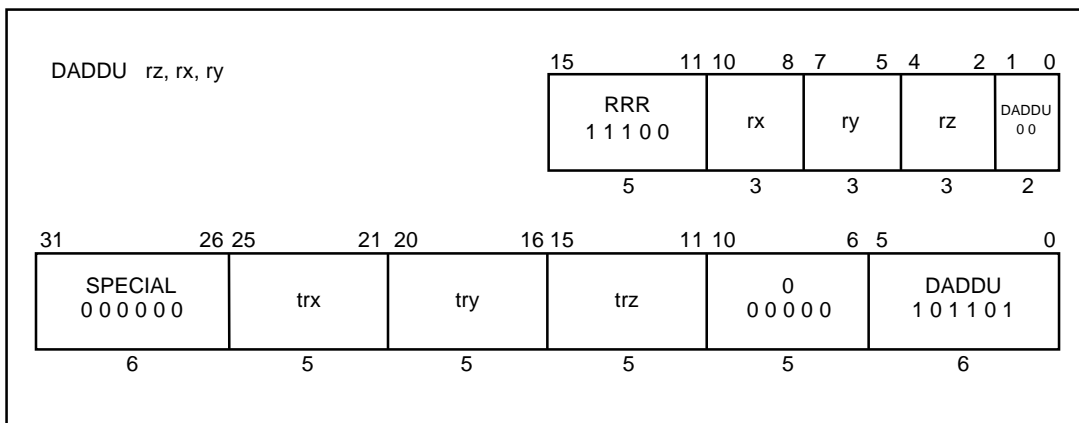

DDIV

Doubleword Divide

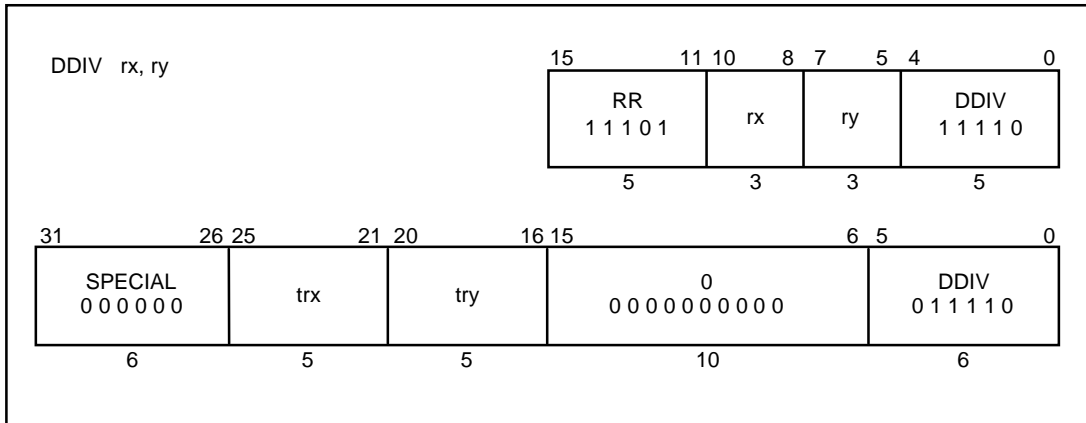

DDIVU

Doubleword Divide Unsigned

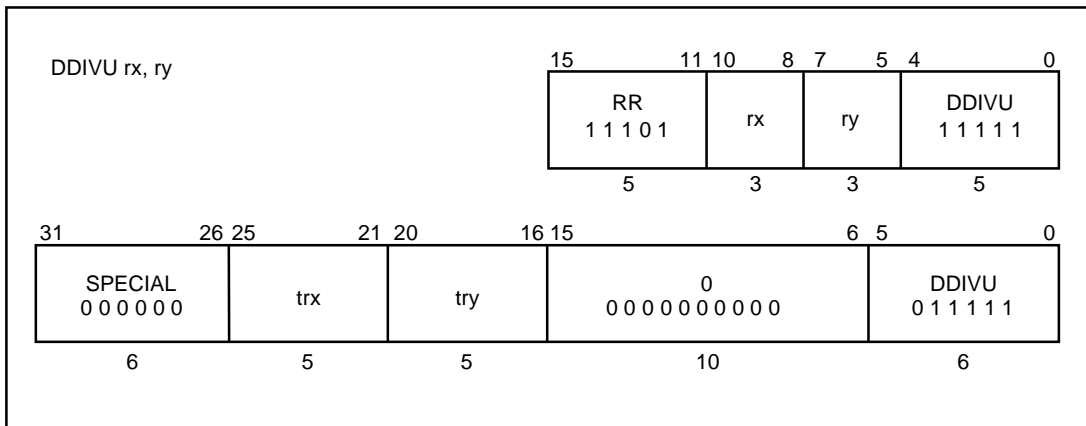

DIV

Divide

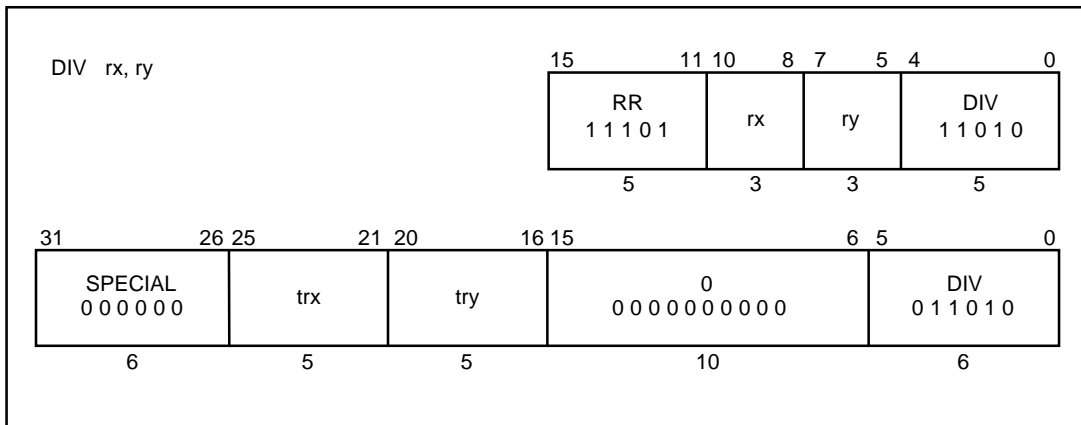

DIVU

Divide Unsigned

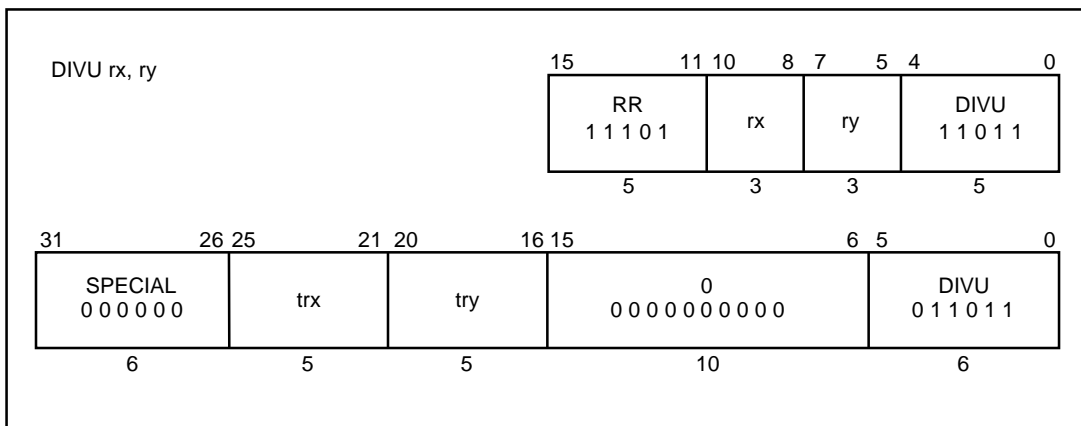

DMULT

Doubleword Multiply

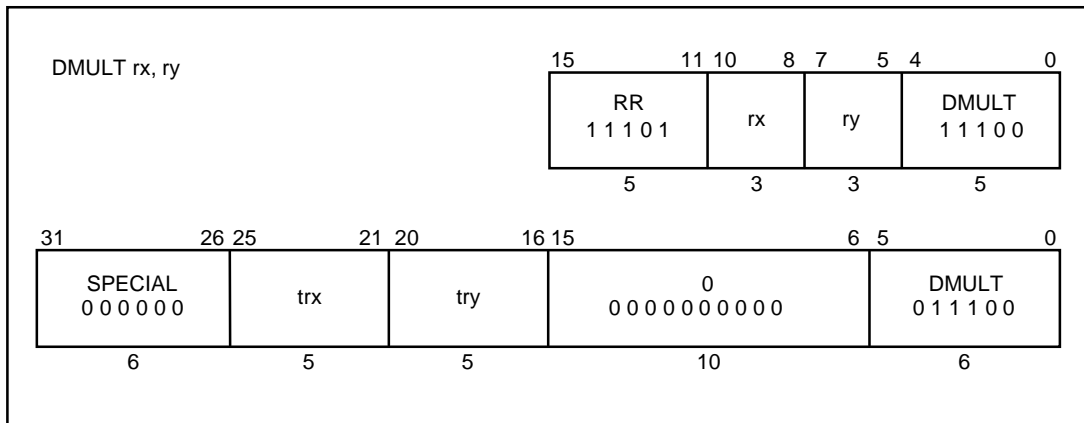

DMULTU

Doubleword Multiply Unsigned

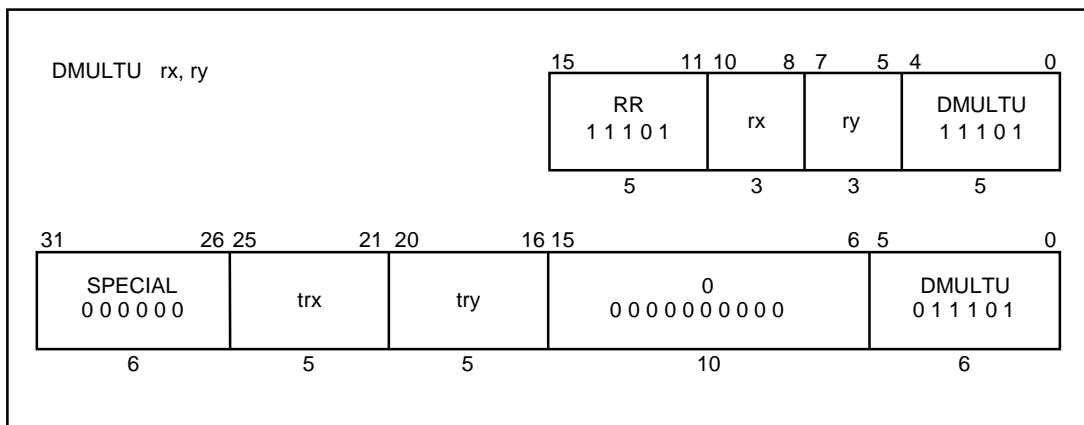

DSLL

Doubleword Shift Left Logical

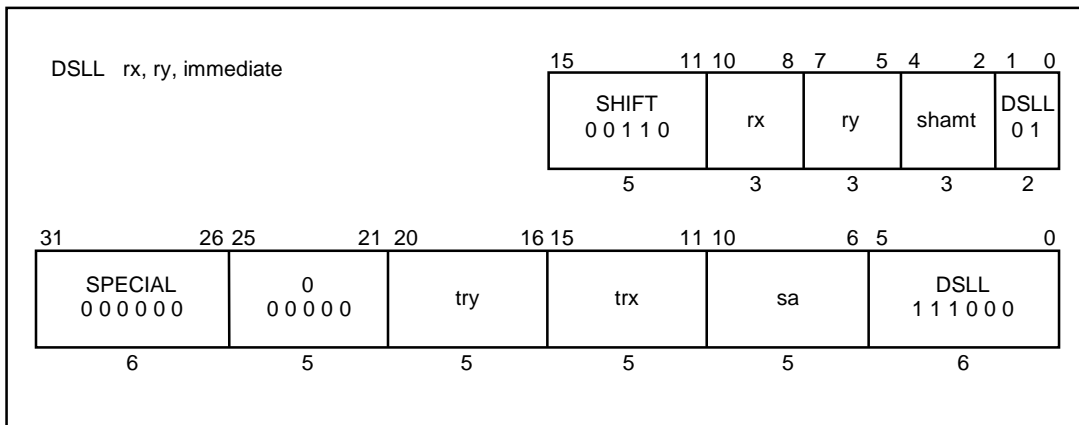

DSLLV

Doubleword Shift Left Logical Variable

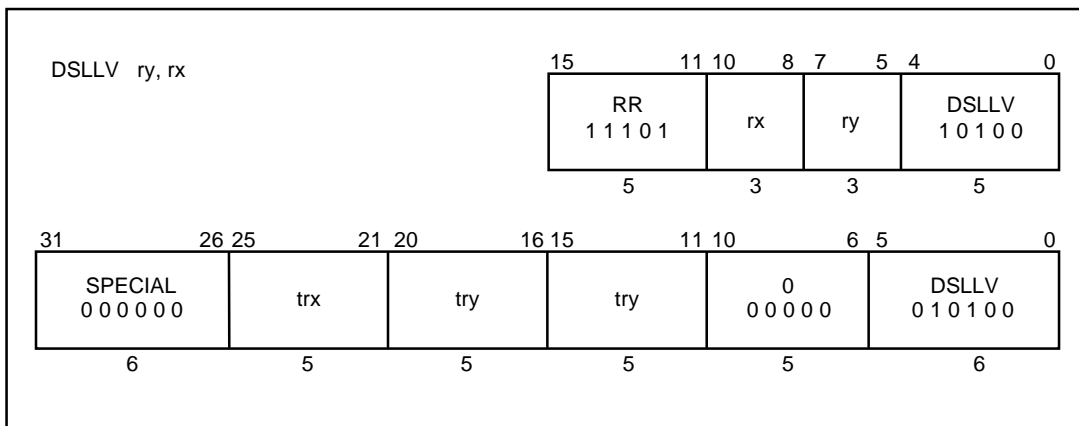

DSRA

Doubleword Shift Right Arithmetic

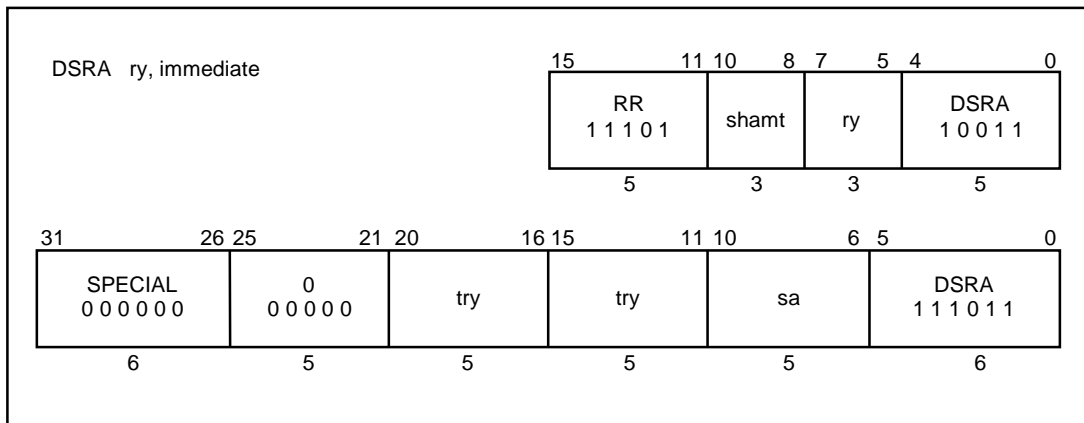

DSRAV

Doubleword Shift Right Arithmetic Variable

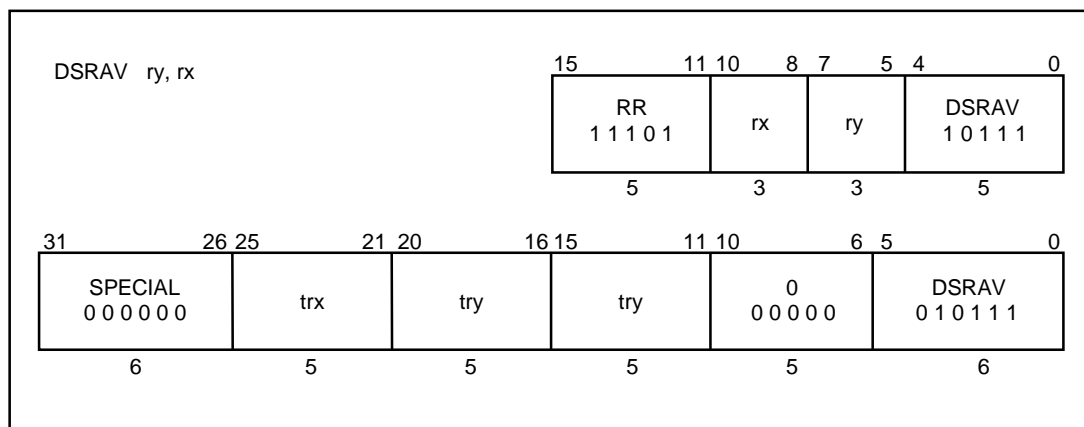

DSRL

Doubleword Shift Right Logical

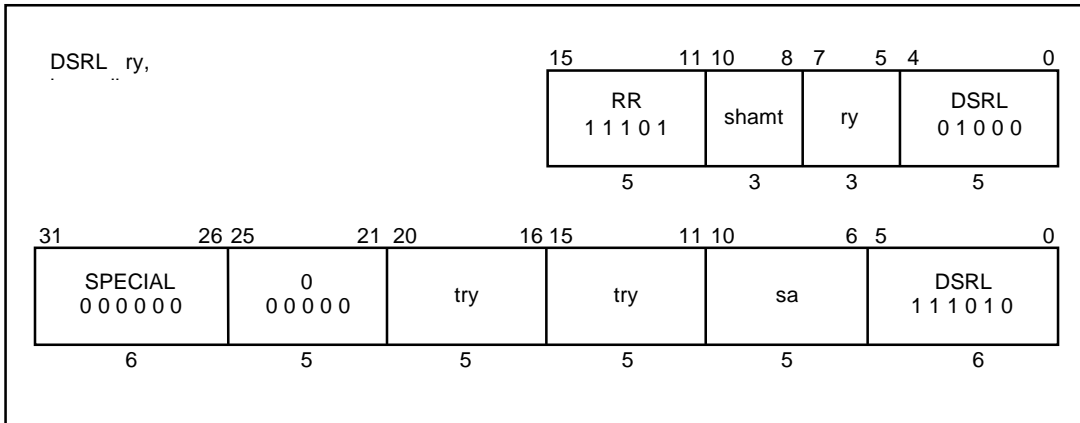

DSRLV

Doubleword Shift Right Logical Variable

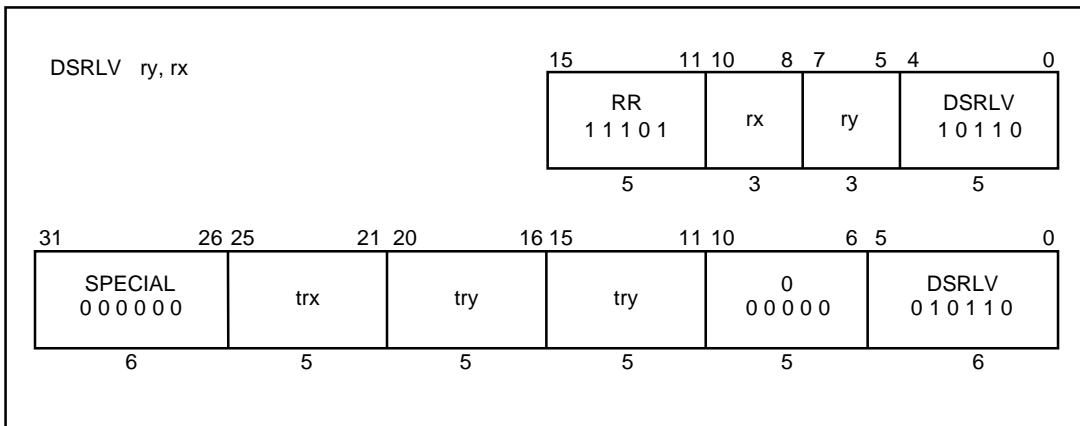

DSUBU

Doubleword Subtract Unsigned

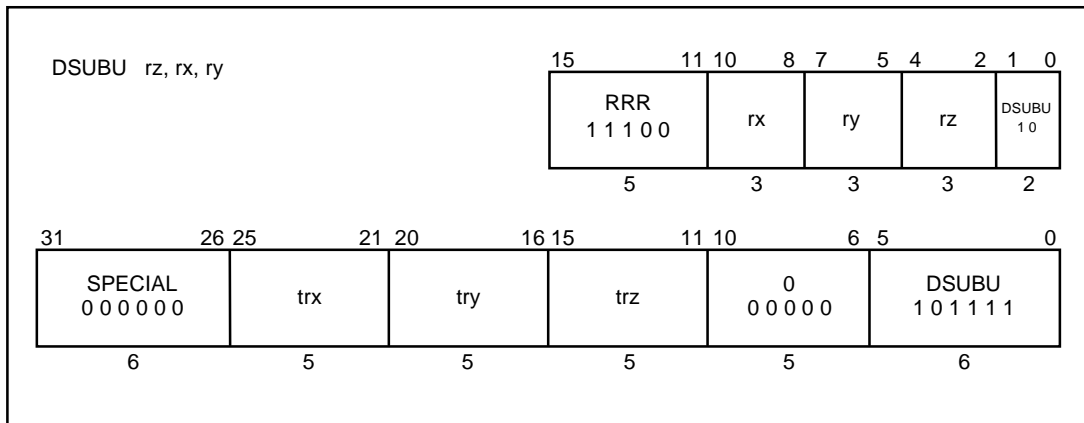

JAL

Jump and Link

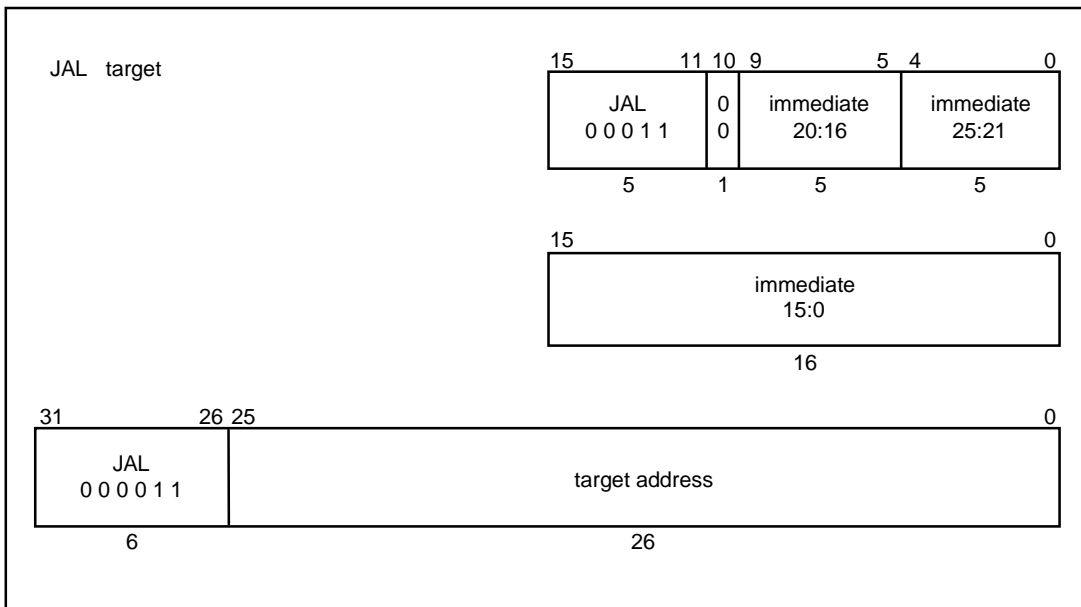

JALR

Jump and Link Register

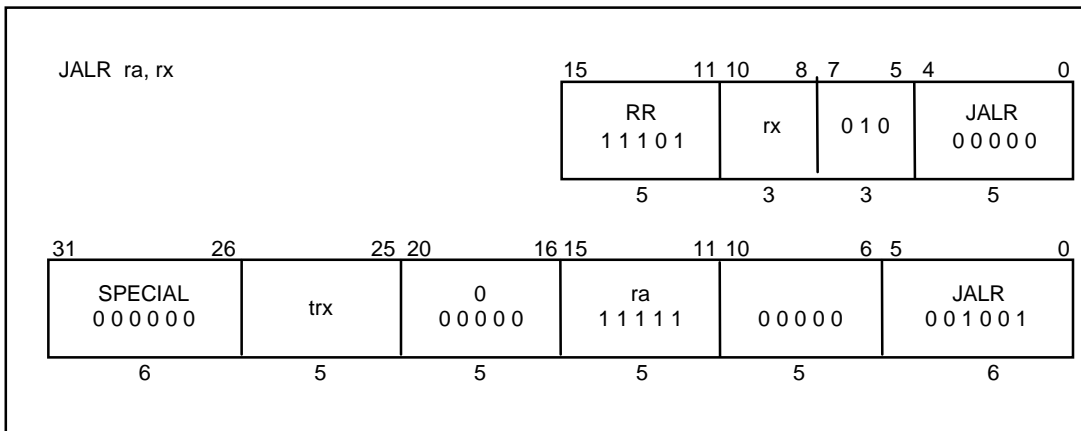

JALX

Jump and Link Exchange

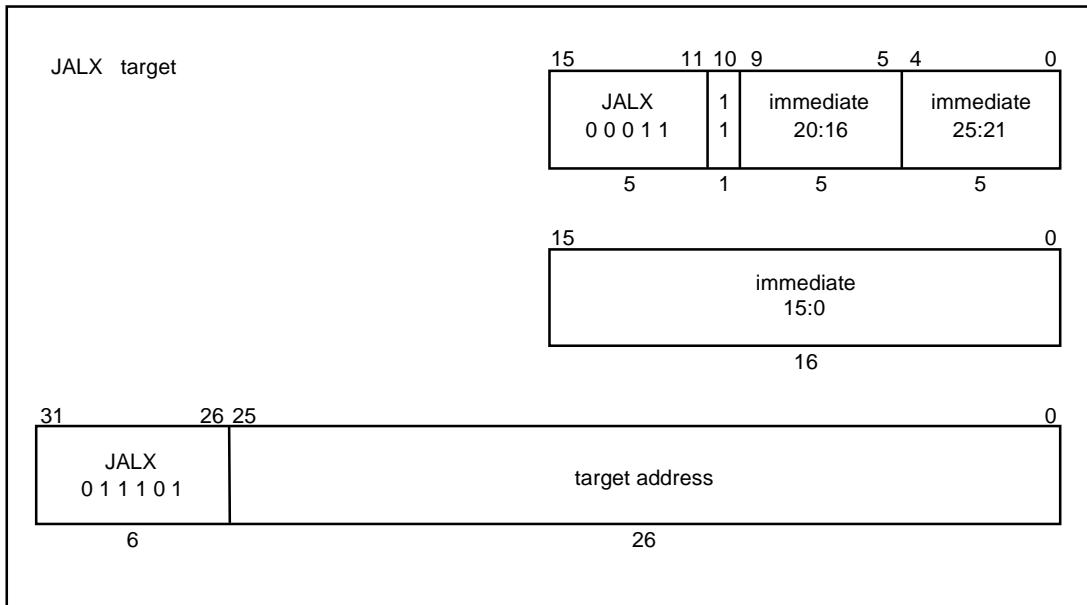

JR

Jump Register

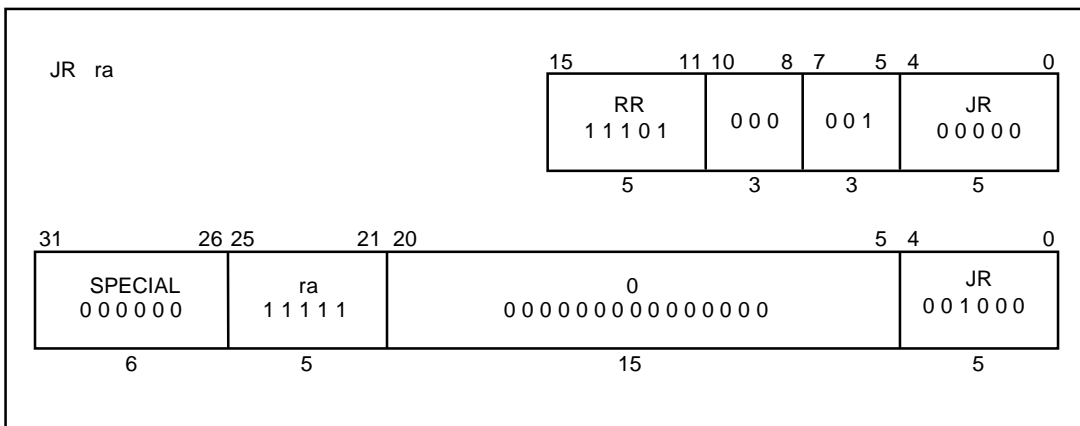
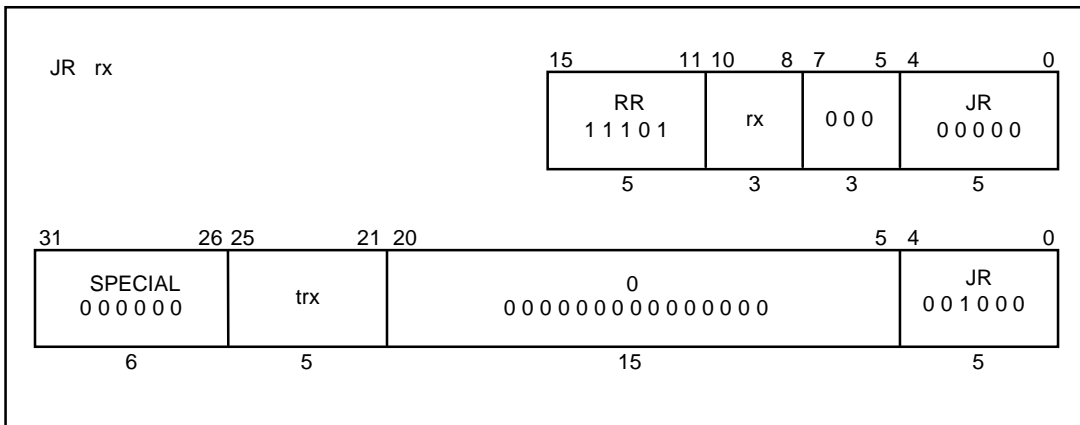

LB

Load Byte

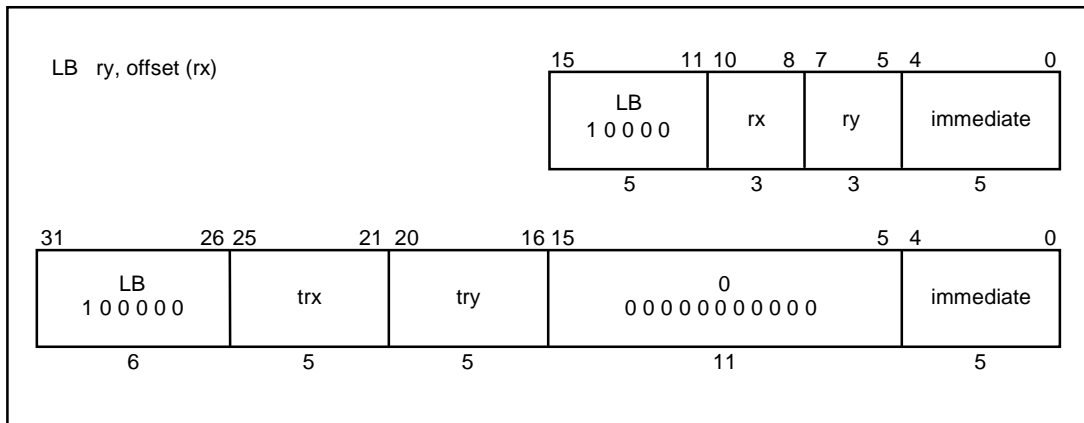

LBU

Load Byte Unsigned

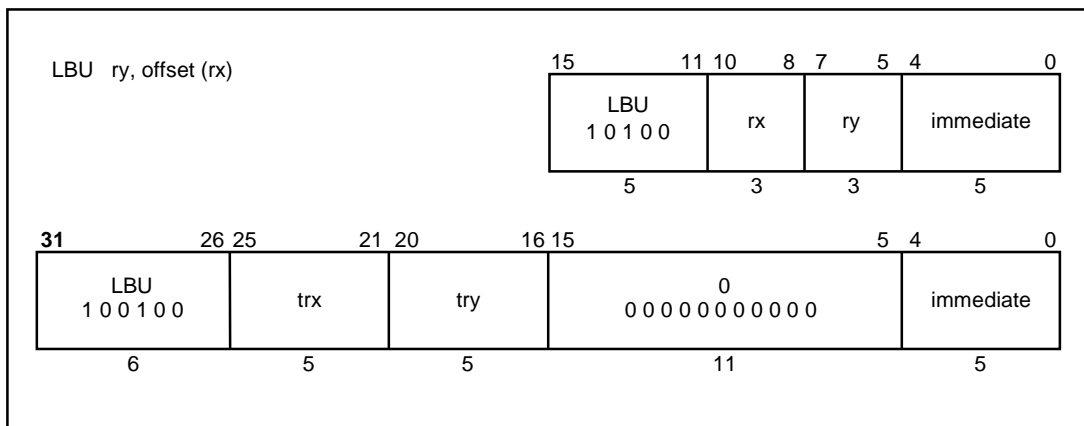

LD

Load Doubleword

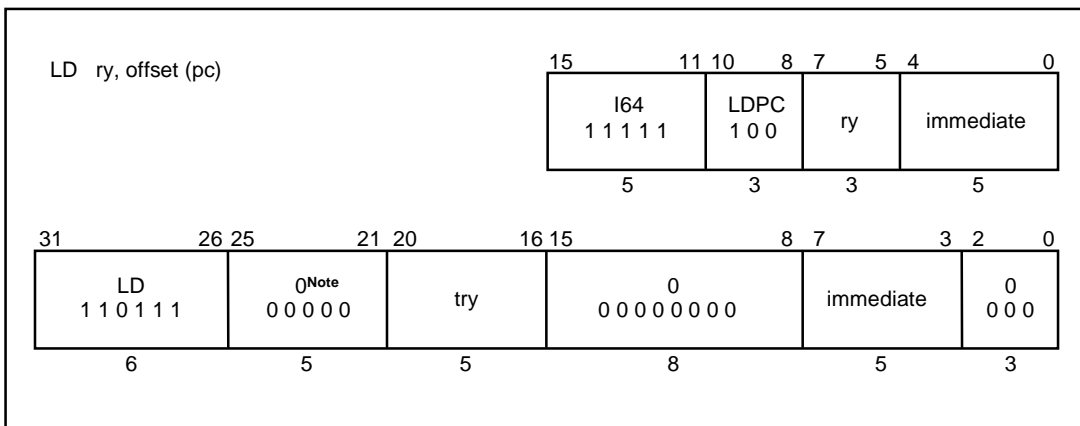
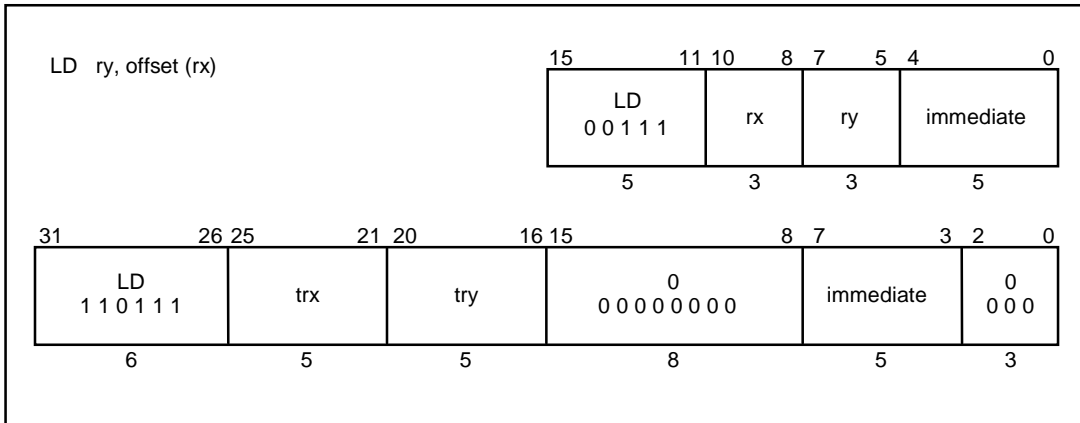

Note Zeros are shown in the field of bits 21 to 25 as placeholders. The 32-bit PC-relative instruction format shown above is provided here only to make the description complete; it is not a valid 32-bit MIPS instruction. Please see Chapter 4 for a complete definition of the semantics of the MIPS16 PC-relative instructions.

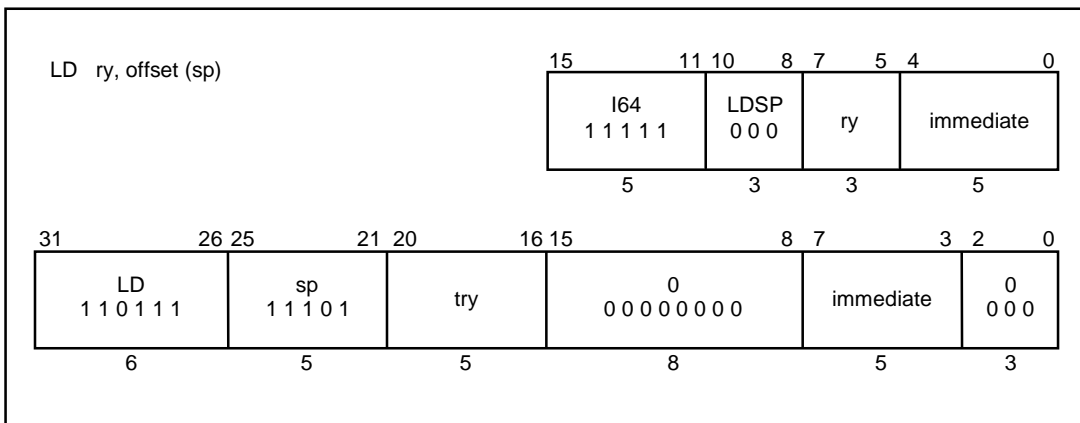

LH

Load Halfword

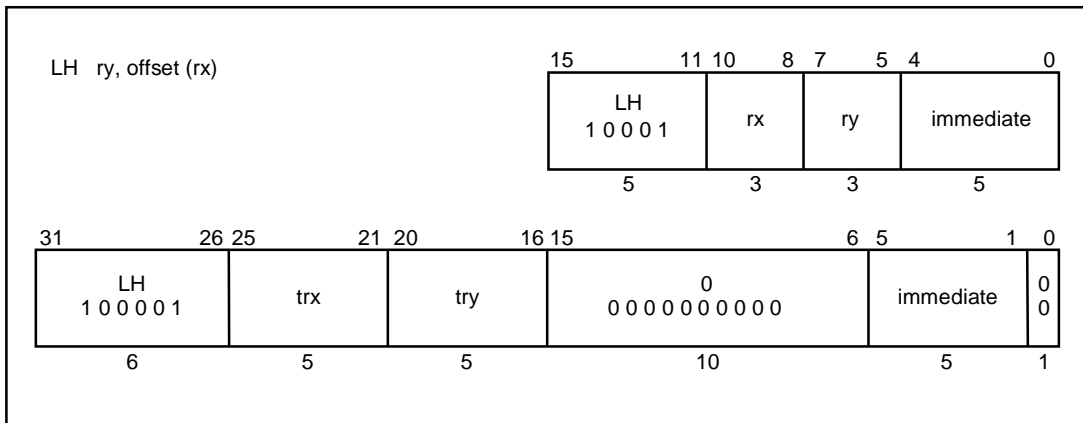

LHU

Load Halfword Unsigned

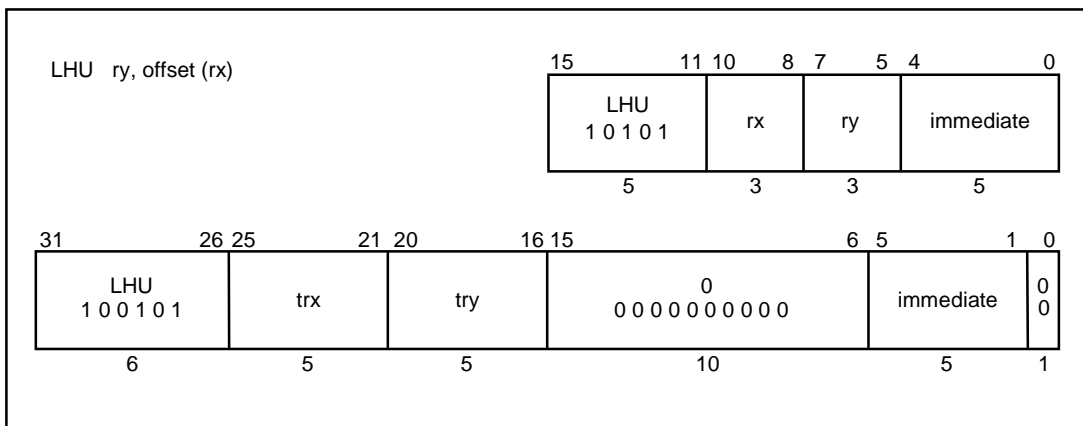

LI

Load Immediate

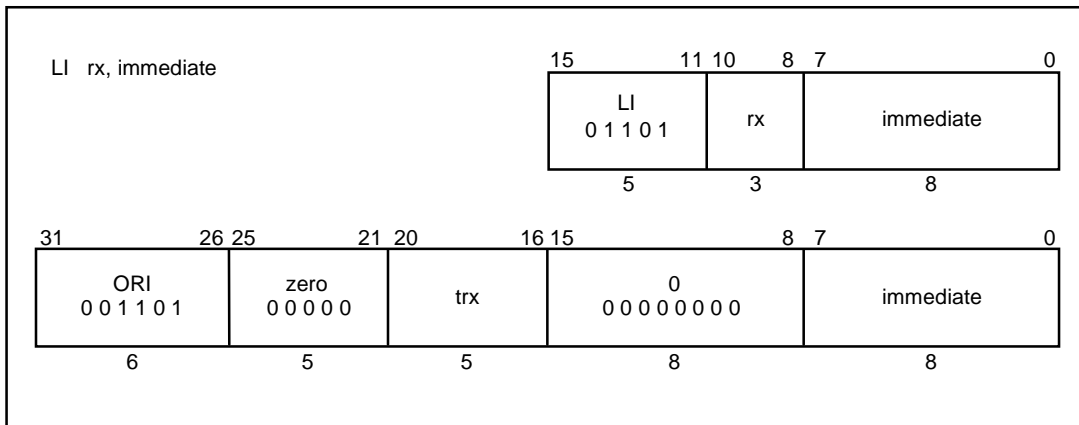

LW

Load Word

(1/2)

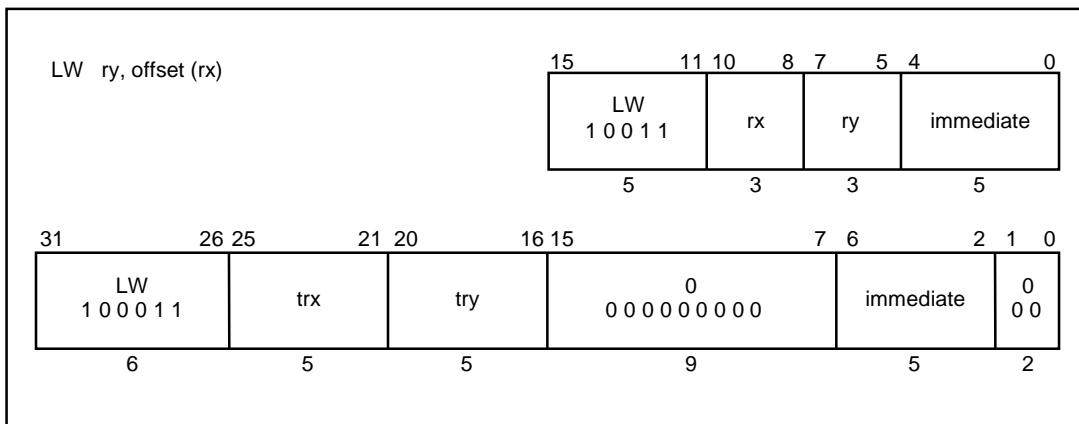

LW**Load Word**

(2/2)

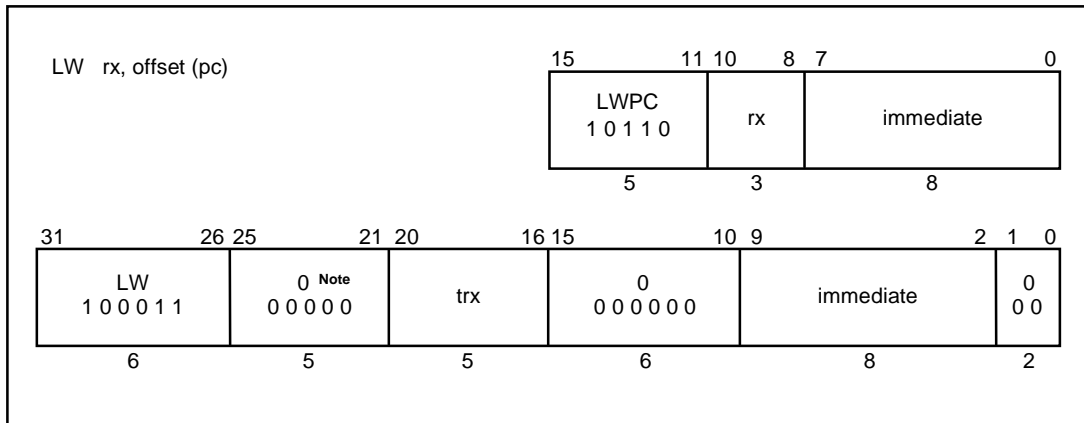

Note Zeros are shown in the field of bits 21 to 25 as placeholders. The 32-bit PC-relative instruction format shown above is provided here only to make the description complete; it is not a valid 32-bit MIPS instruction. Please see Chapter 4 for a complete definition of the semantics of the MIPS16 PC-relative instructions.

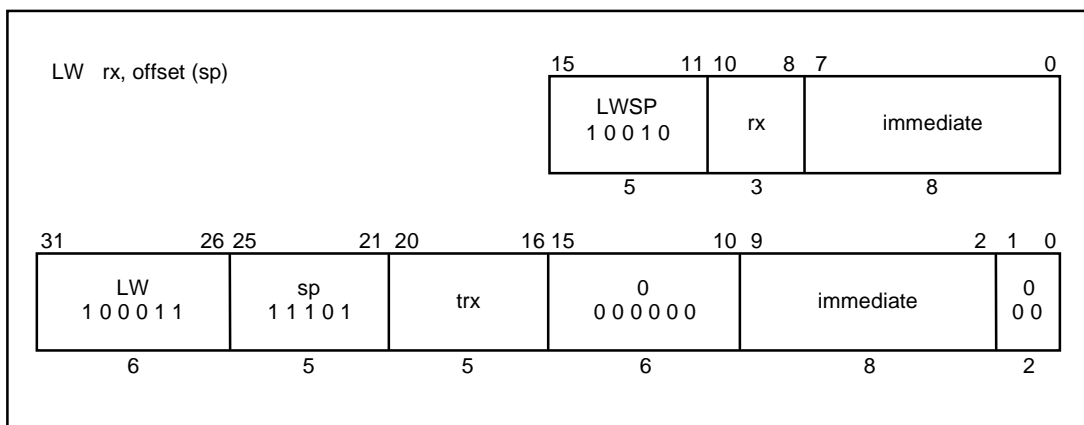

LWU

Load Word Unsigned

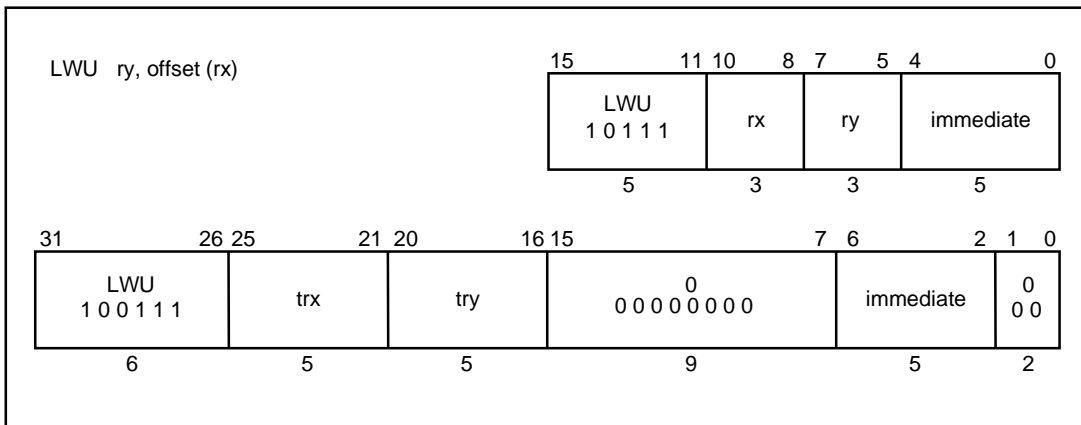

MFHI

Move From HI Register

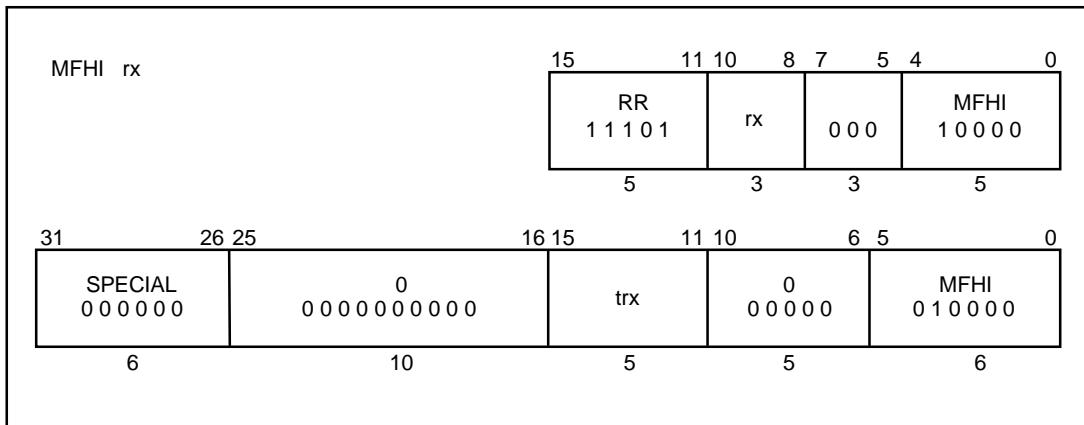

MFLO

Move From LO Register

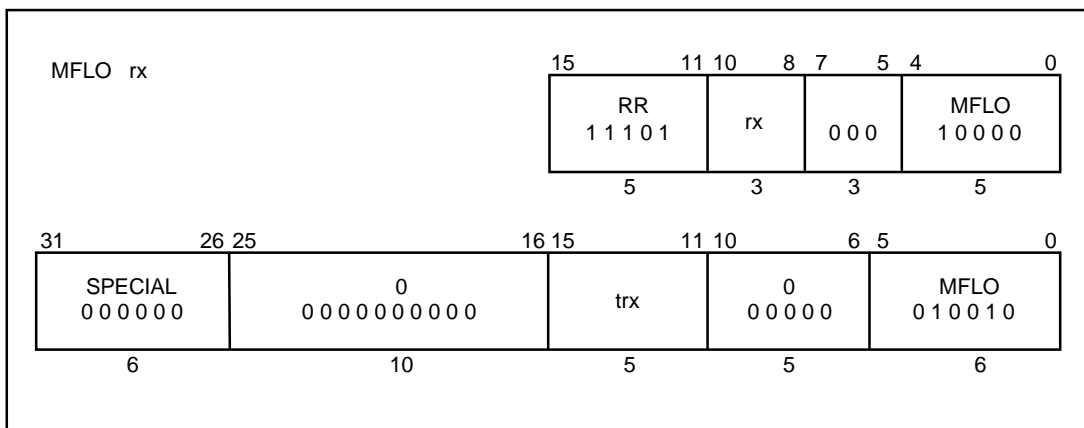

MOVE

Move

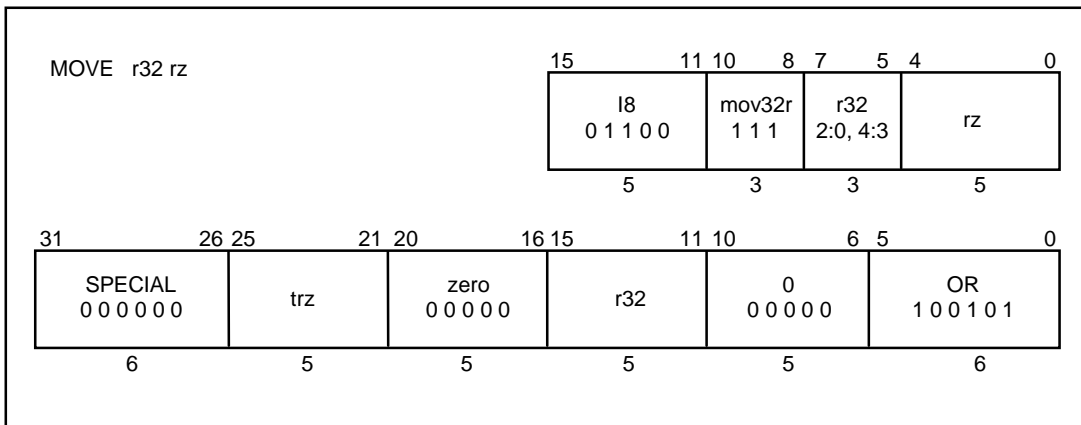
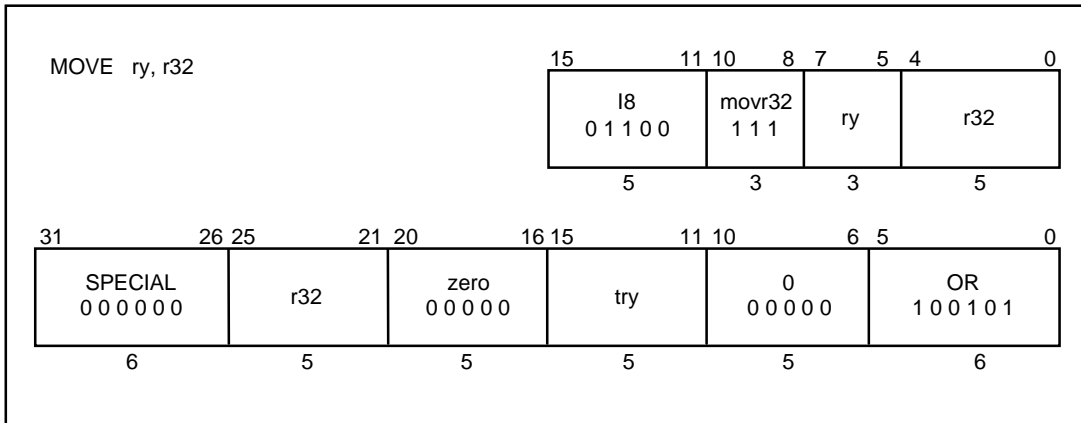

MULT

Multiply

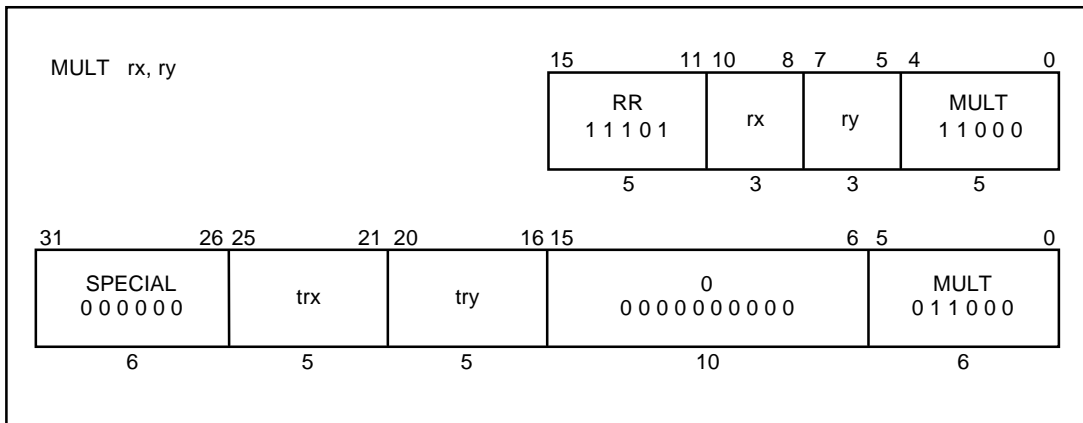

MULTU

Multiply Unsigned

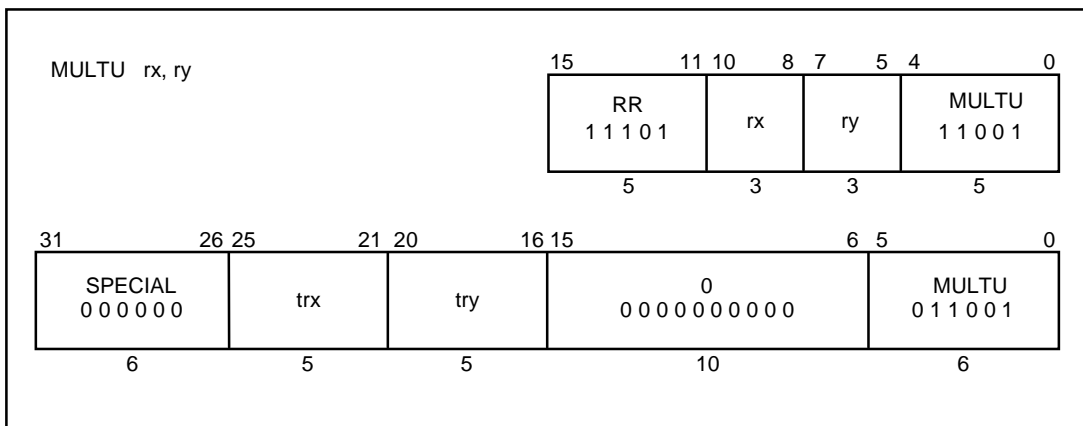

NEG

Negate

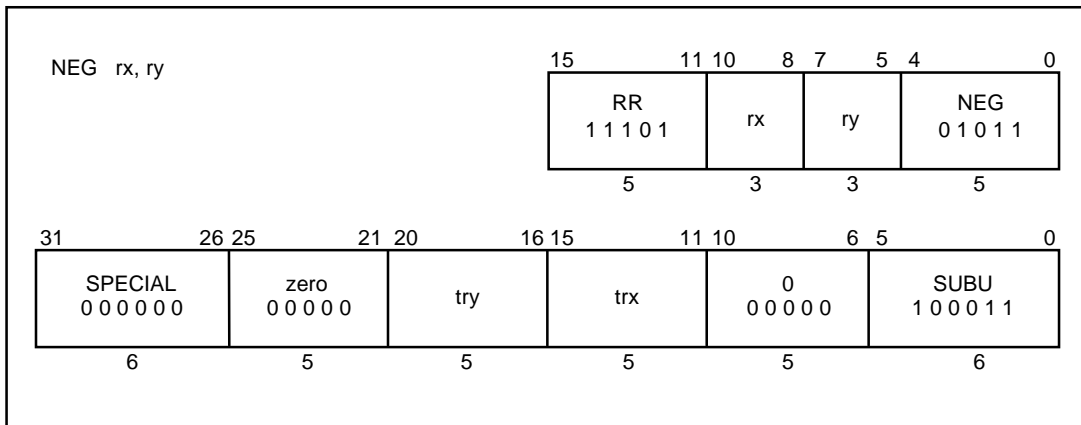

NOT

NOT

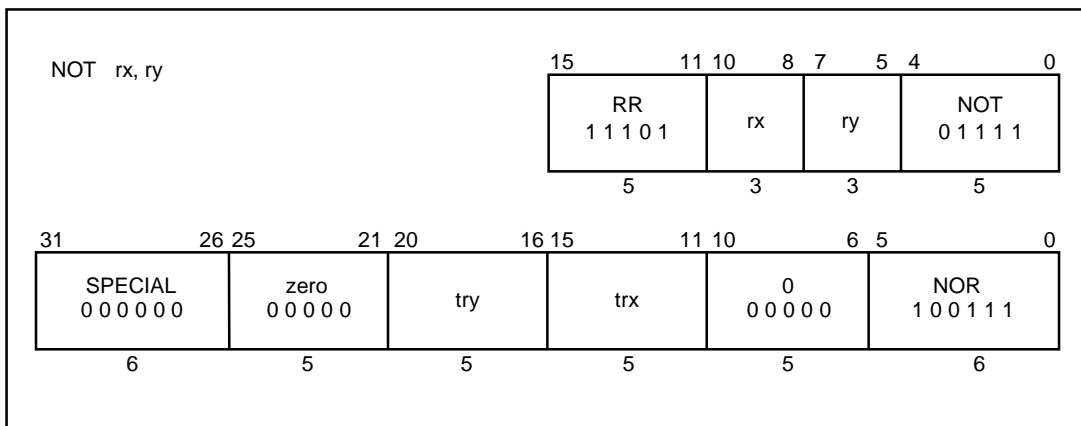

OR

OR

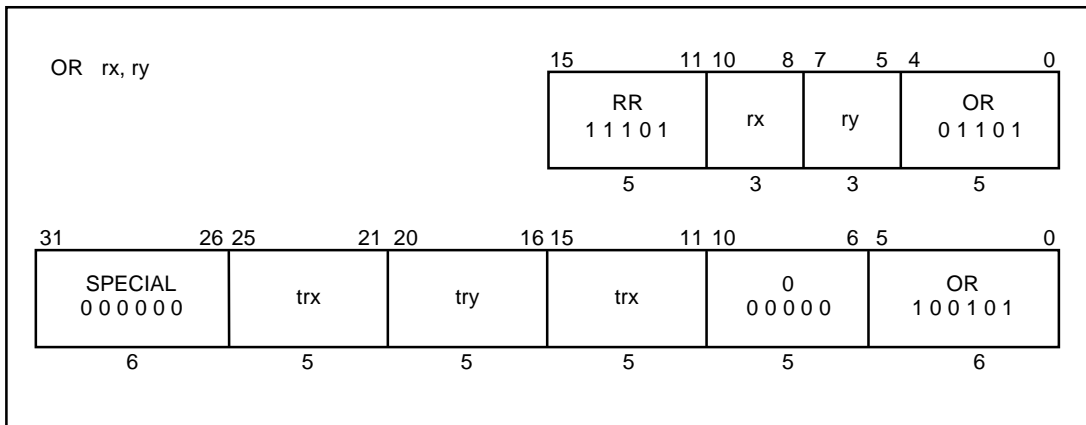

SB

Store Byte

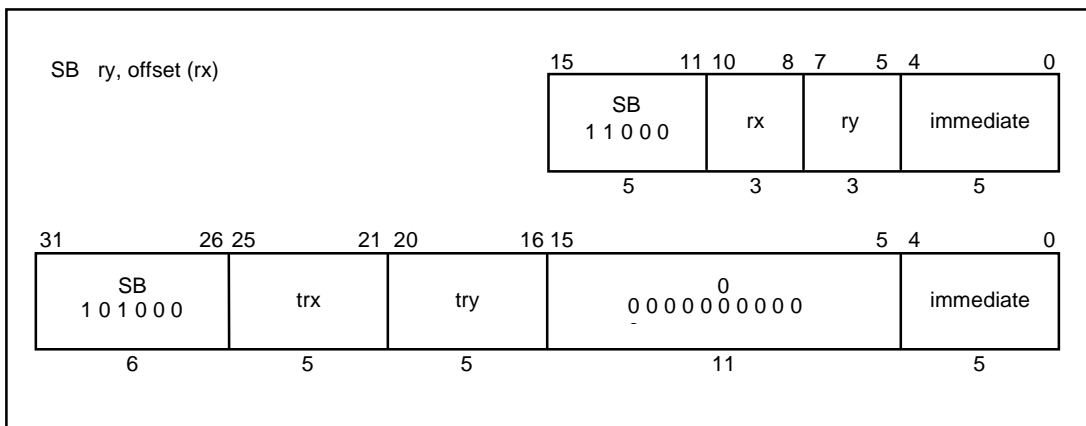

SD

Store Doubleword

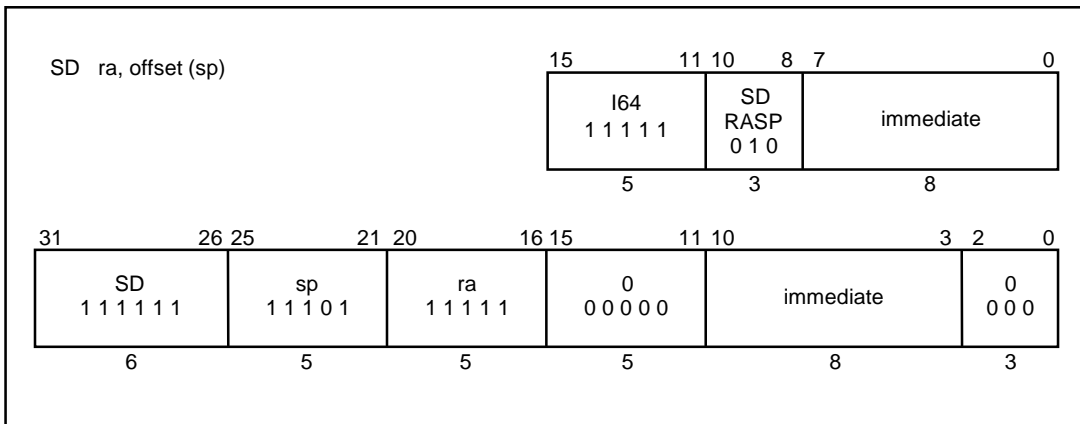
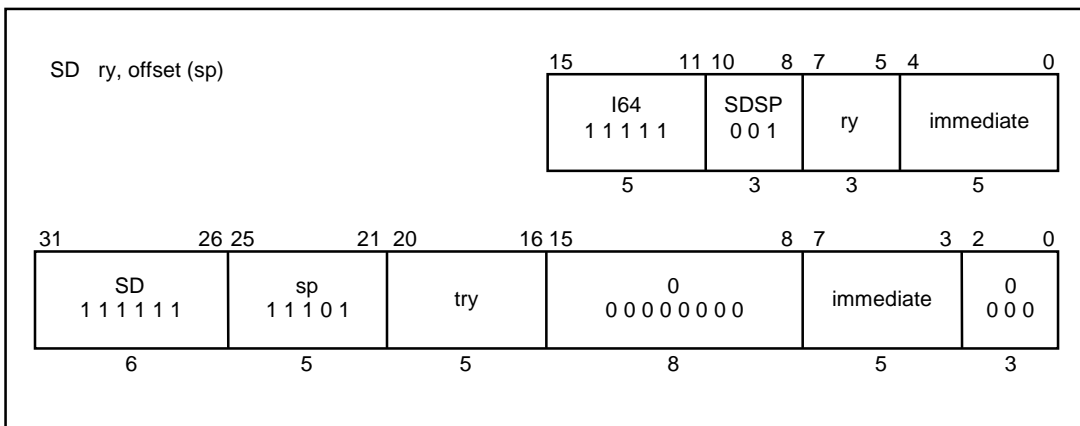
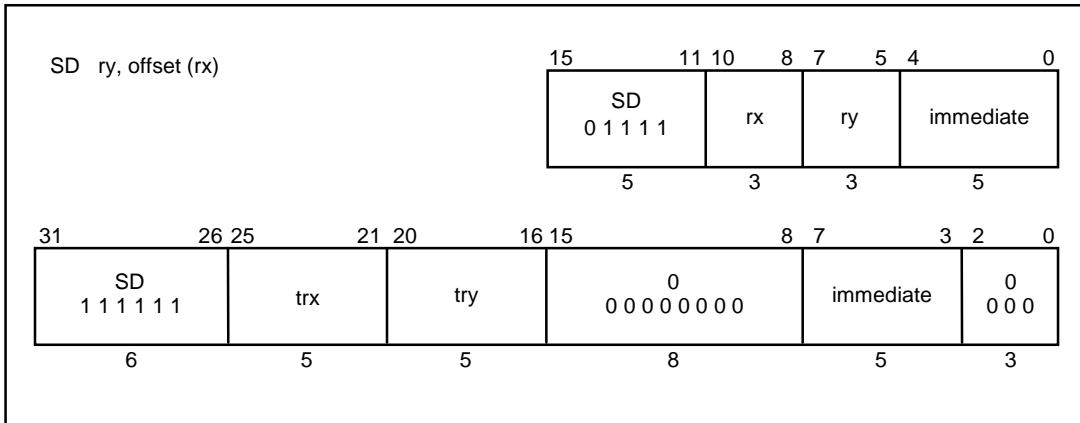

SH

Store Halfword

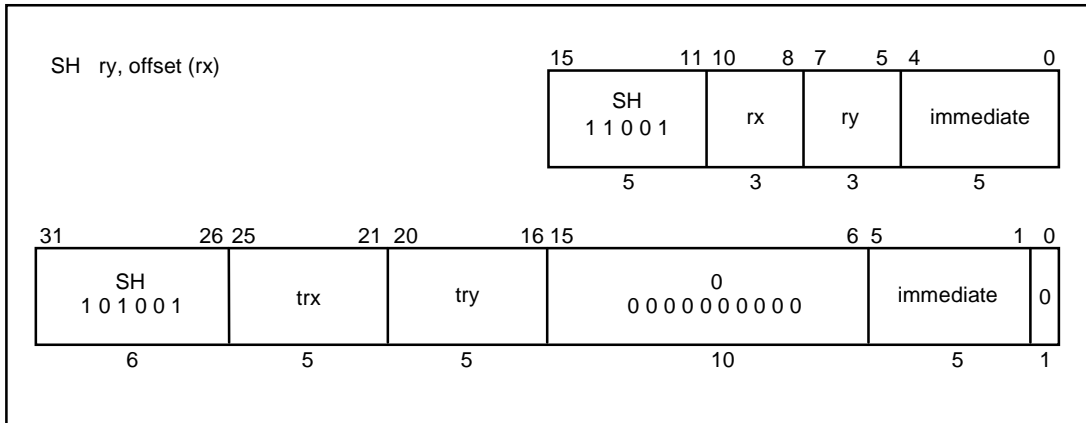

SLL

Shift Left Logical

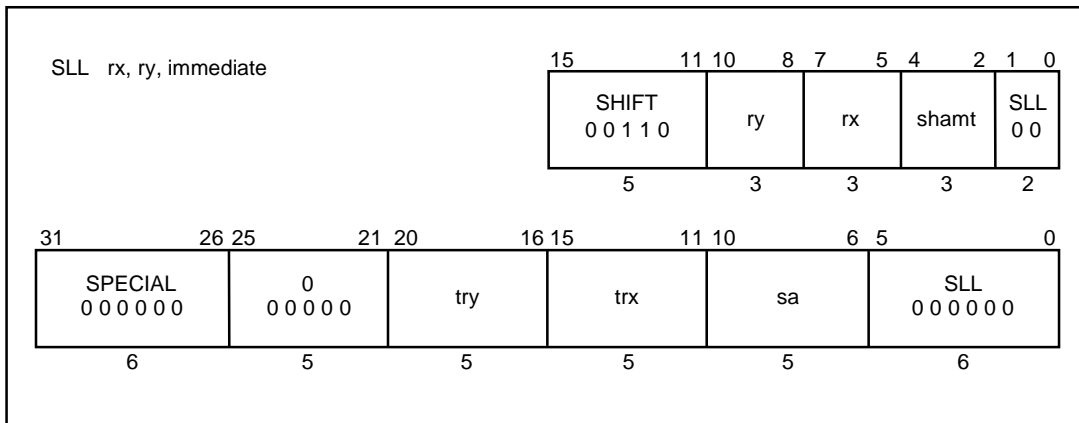

SLLV

Shift Left Logical Variable

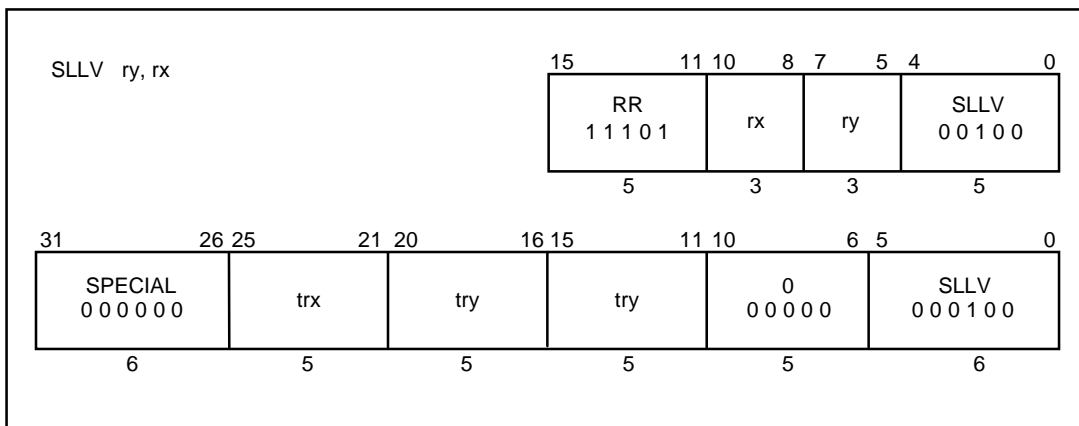

SLT

Set on Less Than

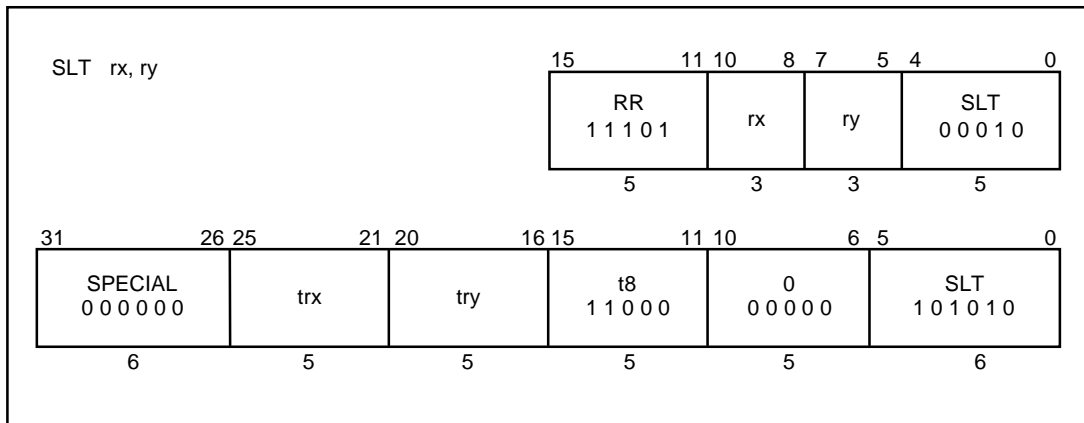

SLTI

Set on Less Than Immediate

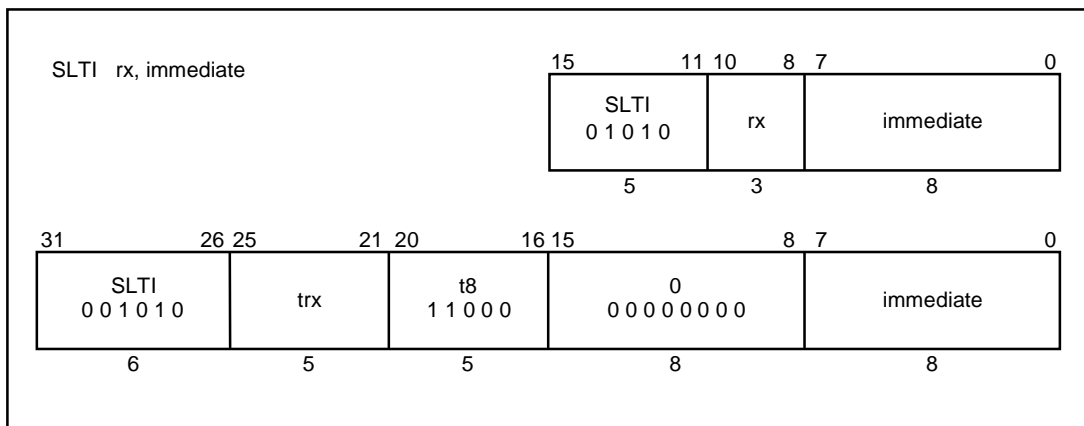

SLTIU

Set on Less Than Immediate Unsigned

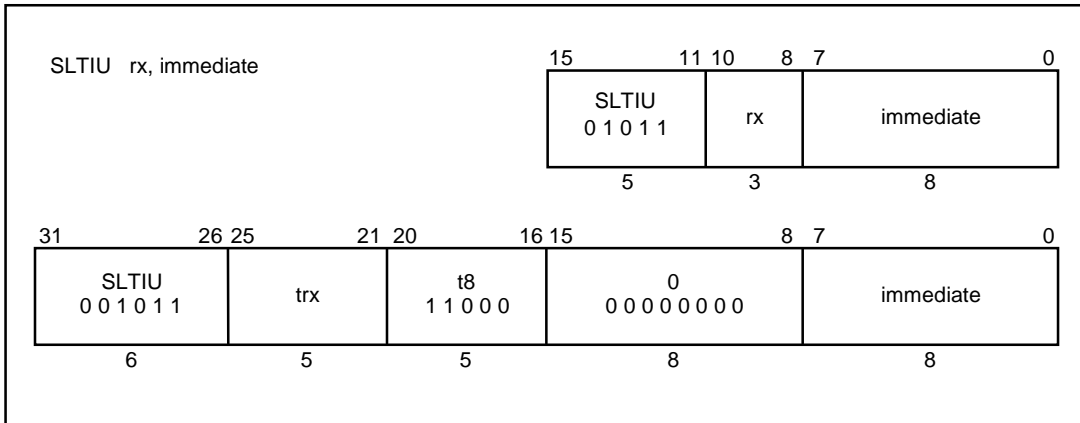

SLTU

Set on Less Than Unsigned

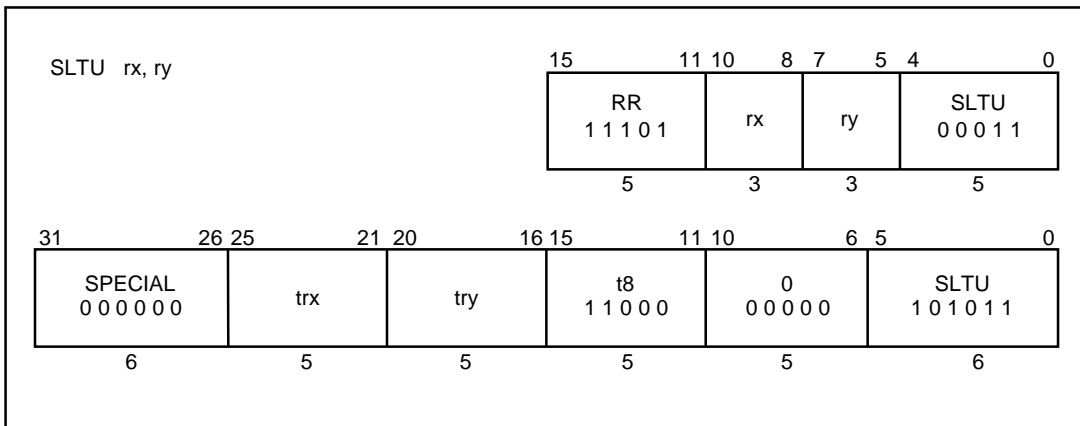

SRA

Shift Right Arithmetic

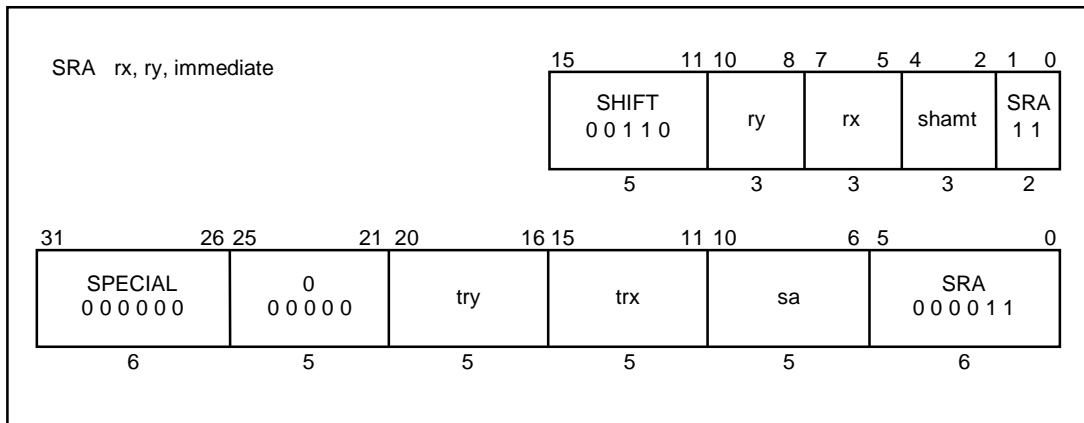

SRAV

Shift Right Arithmetic Variable

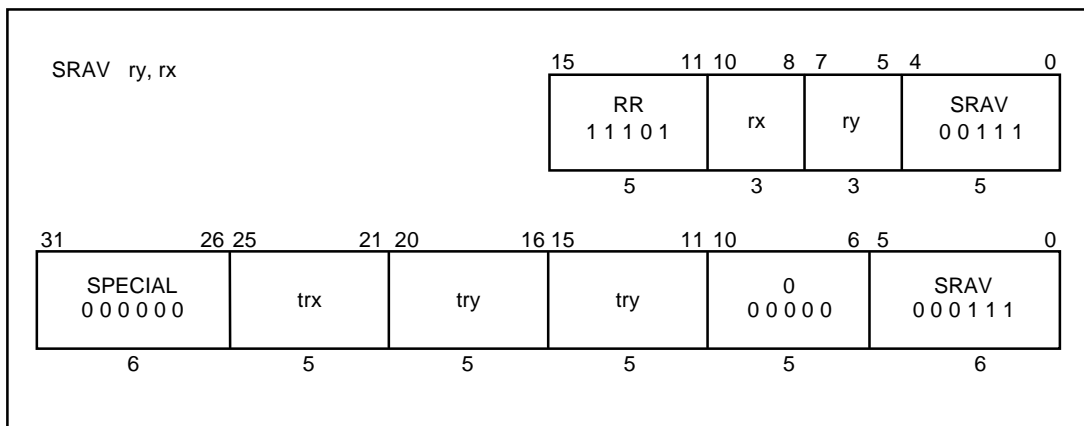

SRL

Shift Right Logical

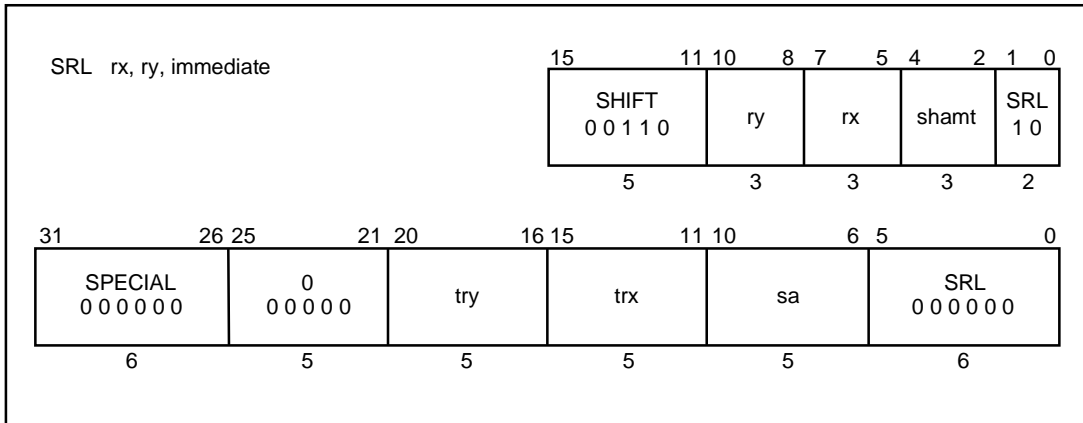

SRLV

Shift Right Logical Variable

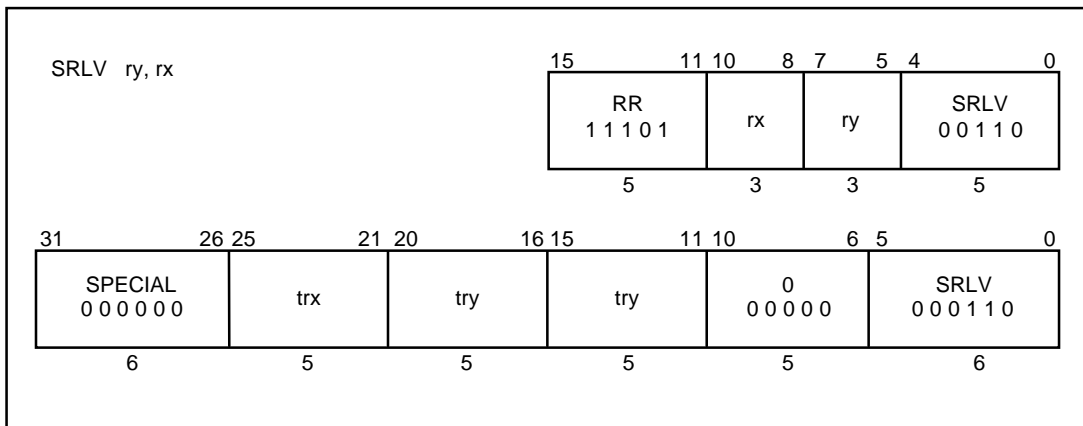

SW

Store Word

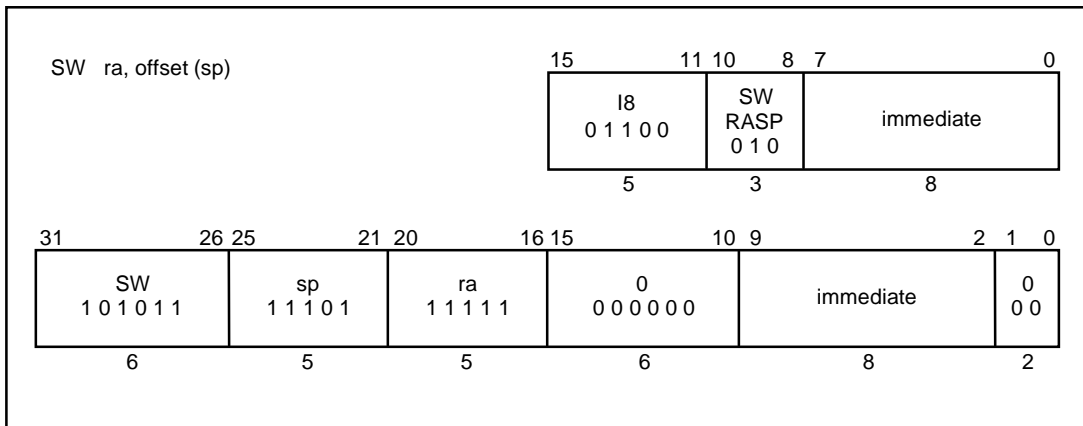
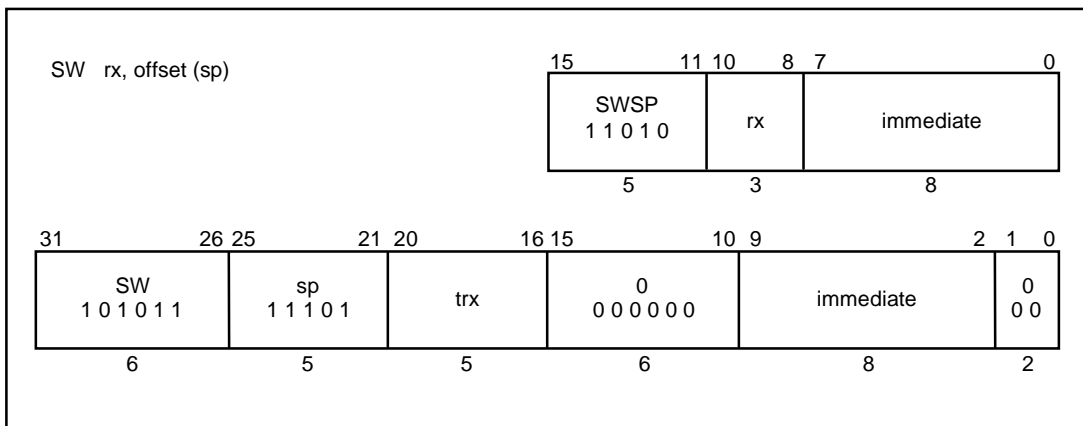
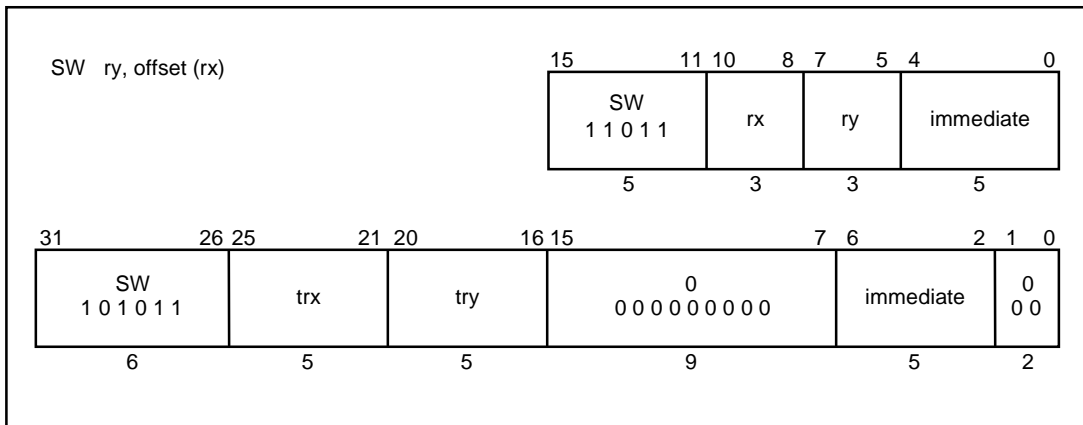

SUBU

Subtract Unsigned

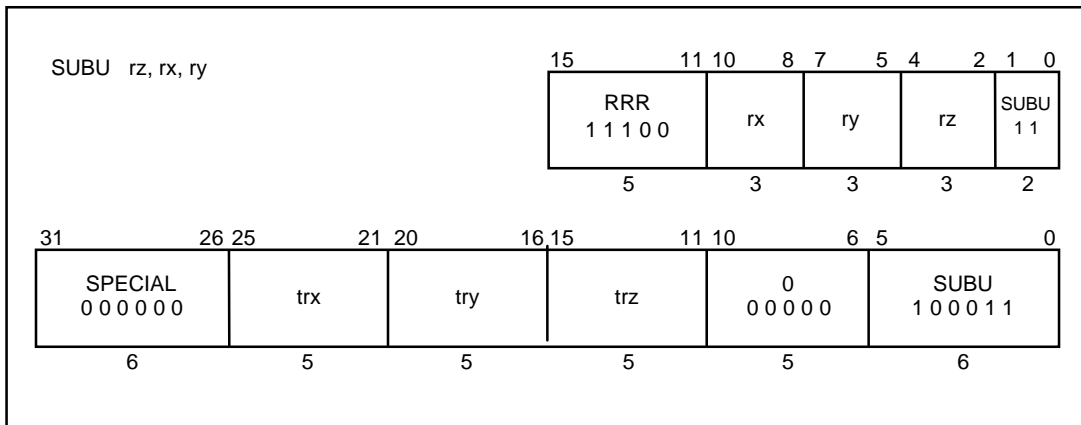

XOR

Exclusive OR

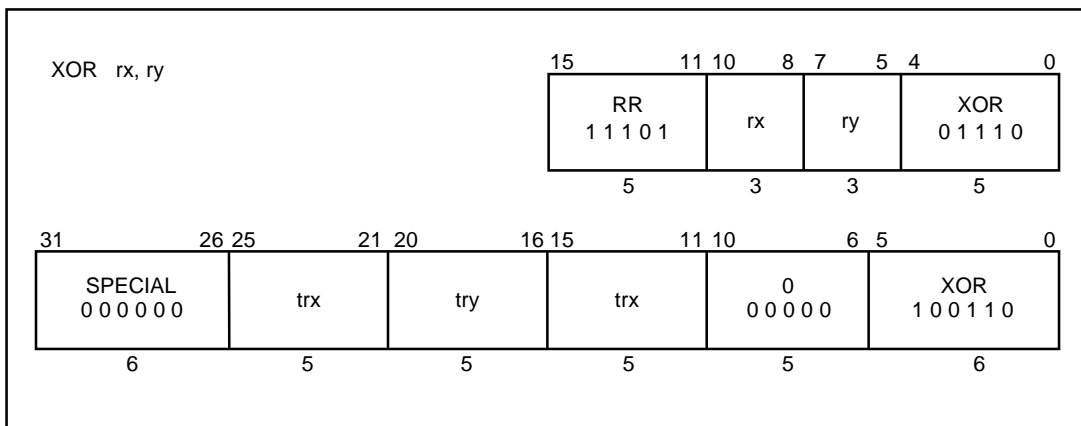

CHAPTER 29 VR4181 COPROCESSOR 0 HAZARDS

The VR4110 CPU core avoids contention of its internal resources by causing a pipeline interlock in such cases as when the contents of the destination register of an instruction are used as a source in the succeeding instruction. Therefore, instructions such as NOP must not be inserted between instructions.

However, interlocks do not occur on the operations related to the CP0 registers and the TLB. Therefore, contention of internal resources should be considered when composing a program that manipulates the CP0 registers or the TLB. The CP0 hazards define the number of NOP instructions that is required to avoid contention of internal resources, or the number of instructions unrelated to contention. This chapter describes the CP0 hazards.

The CP0 hazards of the VR4110 CPU core are as or less stringent than those of the VR4000. Table 30-1 lists the Coprocessor 0 hazards of the VR4110 CPU core. Code that complies with these hazards will run without modification on the VR4000.

The contents of the CP0 registers or the bits in the “Source” column of this table can be used as a source after they are fixed.

The contents of the CP0 registers or the bits in the “Destination” column of this table can be available as a destination after they are stored.

Based on this table, the number of NOP instructions required between instructions related to the TLB is computed by the following formula, and so is the number of instructions unrelated to contention:

$$(\text{Destination Hazard number of A}) - [(\text{Source Hazard number of B}) + 1]$$

As an example, to compute the number of instructions required between an MTC0 and a subsequent MFC0 instruction, this is:

$$(5) - (3 + 1) = 1 \text{ instruction}$$

The CP0 hazards do not generate interlocks of pipeline. Therefore, the required number of instruction must be controlled by program.

Table 29-1. VR4181 Coprocessor 0 Hazards

Operation	Source		Destination	
	Source Name	No. of cycles	Destination Name	No. of cycles
MTC0			cpr rd	5
MFC0	cpr rd	3		
TLBR	Index, TLB	2	PageMask, EntryHi, EntryLo0, EntryLo1	5
TLBWI TLBWR	Index or Random, PageMask, EntryHi, EntryLo0, EntryLo1	2	TLB	5
TLBP	PageMask, EntryHi	2	Index	6
ERET	EPC or ErrorEPC, TLB	2	Status.EXL, Status.ERL	4
	Status	2		
CACHE Index Load Tag			TagLo, TagHi, PErr	5
CACHE Index Store Tag	TagLo, TagHi, PErr	3		
CACHE Hit ops.	cache line	3	cache line	5
Coprocessor usable test	Status.CU, Status.KSU, Status.EXL, Status.ERL	2		
Instruction fetch	EntryHi.ASID, Status.KSU, Status.EXL, Status.ERL, Status.RE, Config.K0C	2		
	TLB	2		
Instruction fetch exception			EPC, Status	4
			Cause, BadVAddr, Context, XContext	5
Interrupt signals	Cause.IP, Status.IM, Status.IE, Status.EXL, Status.ERL	2		
Load/Store	EntryHi.ASID, Status.KSU, Status.EXL, Status.ERL, Status.RE, Config.K0C, TLB	3		
	Config.AD, Config.EP	3		
	WatchHi, WatchLo	3		
Load/Store exception			EPC, Status, Cause, BadVAddr, Context, XContext	5
TLB shutdown			Status.TS	2 (Inst.), 4 (Data)

- Remarks**
1. The instruction following MTC0 must not be MFC0.
 2. The five instructions following MTC0 to Status register that changes KSU and sets EXL and ERL may be executed in the new mode, and not kernel mode. This can be avoided by setting EXL first, leaving KSU set to kernel, and later changing KSU.
 3. There must be two non-load, non-CACHE instructions between a store and a CACHE instruction directed to the same primary cache line as the store.

- Cautions**
1. If the setting of the K0 bit in the Config register is changed to uncached mode by MTC0, the accessed memory area is switched to the uncached one at the instruction fetch of the third instruction after MTC0.
 2. A stall of several instructions occurs if a jump or branch instruction is executed immediately after the setting of the ITS bit in the Status register.

The status during execution of the following instruction for which CP0 hazards must be considered is described below.

(1) MTC0

Destination: The completion of writing to a destination register (CP0) of MTC0.

(2) MFC0

Source: The confirmation of a source register (CP0) of MFC0.

(3) TLBR

Source: The confirmation of the status of TLB and the Index register before the execution of TLBR.

Destination: The completion of writing to a destination register (CP0) of TLBR.

(4) TLBWI, TLBWR

Source: The confirmation of a source register of these instructions and registers used to specify a TLB entry.

Destination: The completion of writing to TLB by these instructions.

(5) TLBP

Source: The confirmation of the PageMask register and the EntryHi register before the execution of TLBP.

Destination: The completion of writing the result of execution of TLBP to the Index register.

(6) ERET

Source: The confirmation of registers containing information necessary for executing ERET.

Destination: The completion of the processor state transition by the execution of ERET.

(7) CACHE Index Load Tag

Destination: The completion of writing the results of execution of this instruction to the related registers.

(8) CACHE Index Store Tag

Source: The confirmation of registers containing information necessary for executing this instruction.

(9) Coprocessor Usable Test

Source: The confirmation of modes set by the bits of the CP0 registers in the "Source" column.

- Examples**
1. When accessing the CP0 registers in User mode after the contents of the CU0 bit of the Status register are modified, or when executing an instruction such as TLB instructions, CACHE instructions, or branch instructions that use the resource of the CP0.
 2. When accessing the CP0 registers in the operating mode set in the Status register after the KSU, EXL, and ERL bits of the Status register are modified.

(10) Instruction Fetch

Source: The confirmation of the operating mode and TLB necessary for instruction fetch.

- Examples**
1. When changing the operating mode from User to Kernel and fetching instructions after the KSU, EXL, and ERL bits of the Status register are modified.
 2. When fetching instructions using the modified TLB entry after TLB modification.

(11) Instruction Fetch Exception

Destination: The completion of writing to registers containing information related to the exception when an exception occurs on instruction fetch.

(12) Interrupts

Source: The confirmation of registers judging the condition of occurrence of interrupt when an interrupt factor is detected.

(13) Loads/Stores

Source: The confirmation of the operating mode related to the address generation of Load/Store instructions, TLB entries, the cache mode set in the K0 bit of the Config register, and the registers setting the condition of occurrence of a Watch exception.

Example When Loads/Stores are executed in the kernel field after changing the mode from User to Kernel.

(14) Load/Store Exception

Destination: The completion of writing to registers containing information related to the exception when an exception occurs on load or store operation.

(15) TLB Shutdown

Destination: The completion of writing to the TS bit of the Status register when a TLB shutdown occurs.

Table 29-2 indicates examples of calculation.

Table 29-2. Calculation Example of CP0 Hazard and Number of Instructions Inserted

Destination	Source	Contending internal resource	Number of instructions inserted	Formula
TLBWR/TLBWI	TLBP	TLB Entry	2	$5 - (2 + 1)$
TLBWR/TLBWI	Load or Store using newly modified TLB	TLB Entry	1	$5 - (3 + 1)$
TLBWR/TLBWI	Instruction fetch using newly modified TLB	TLB Entry	2	$5 - (2 + 1)$
MTC0, Status [CU]	Coprocessor instruction that requires the setting of CU	Status [CU]	2	$5 - (2 + 1)$
TLBR	MFC0 EntryHi	EntryHi	1	$5 - (3 + 1)$
MTC0 EntryLo0	TLBWR/TLBWI	EntryLo0	2	$5 - (2 + 1)$
TLBP	MFC0 Index	Index	2	$6 - (3 + 1)$
MTC0 EntryHi	TLBP	EntryHi	2	$5 - (2 + 1)$
MTC0 EPC	ERET	EPC	2	$5 - (2 + 1)$
MTC0 Status	ERET	Status	2	$5 - (2 + 1)$
MTC0 Status [IE] ^{Note}	Instruction that causes an interrupt	Status [IE]	2	$5 - (2 + 1)$

Note The number of hazards is undefined if the instruction execution sequence is changed by exceptions. In such a case, the minimum number of hazards until the IE bit value is confirmed may be the same as the maximum number of hazards until an interrupt request occurs that is pending and enabled.

[MEMO]

CHAPTER 30 PLL PASSIVE COMPONENTS

The Phase Locked Loop circuit requires several passive components for proper operation, which are connected to VDD_PLL as illustrated in Figure 30-1.

Figure 30-1. Example of Connection of PLL Passive Components

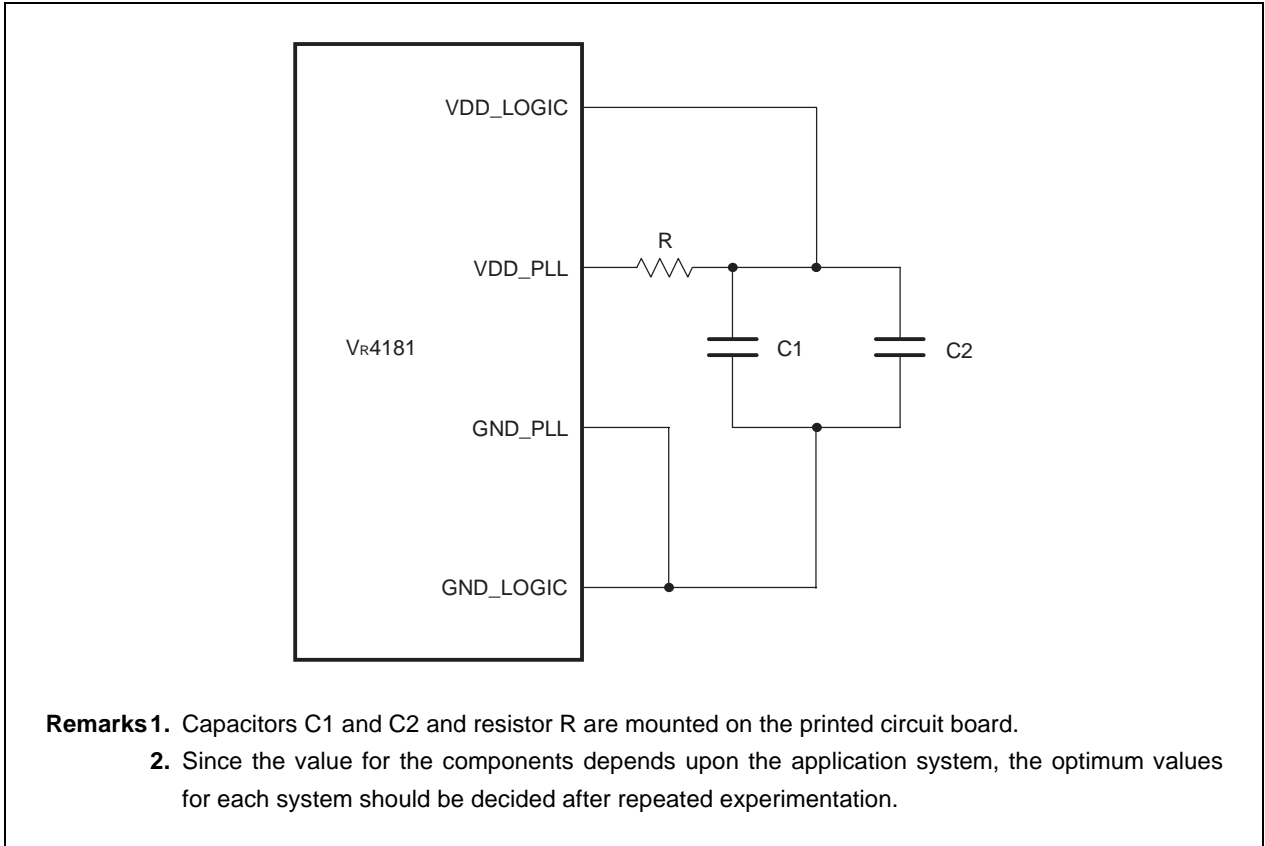

It is essential to isolate the analog power and ground for the PLL circuit (VDD_PLL, GND_PLL) from the regular power and ground (VDD_LOGIC/GND_LOGIC). Initial evaluations have yielded good results with the following values:

$$R = 100 \Omega \quad C1 = 0.1 \mu\text{F} \quad C2 = 1.0 \mu\text{F}$$

Since the optimum values for the filter components depend upon the application and the system noise environment, these values should be considered as starting points for further experimentation within your specific application. In addition, the choke (inductor: L) can be considered for use as an alternative to the resistor (R) for use in filtering the power supply.

[MEMO]

Facsimile Message

Although NEC has taken all possible steps to ensure that the documentation supplied to our customers is complete, bug free and up-to-date, we readily accept that errors may occur. Despite all the care and precautions we've taken, you may encounter problems in the documentation. Please complete this form whenever you'd like to report errors or suggest improvements to us.

From:

Name

Company

Tel.

FAX

Address

Thank you for your kind support.

North America

NEC Electronics Inc.
Corporate Communications Dept.
Fax: 1-800-729-9288
1-408-588-6130

Hong Kong, Philippines, Oceania

NEC Electronics Hong Kong Ltd.
Fax: +852-2886-9022/9044

Asian Nations except Philippines

NEC Electronics Singapore Pte. Ltd.
Fax: +65-250-3583

Europe

NEC Electronics (Europe) GmbH
Technical Documentation Dept.
Fax: +49-211-6503-274

Korea

NEC Electronics Hong Kong Ltd.
Seoul Branch
Fax: 02-528-4411

Japan

NEC Semiconductor Technical Hotline
Fax: 044-435-9608

South America

NEC do Brasil S.A.
Fax: +55-11-6462-6829

Taiwan

NEC Electronics Taiwan Ltd.
Fax: 02-2719-5951

I would like to report the following error/make the following suggestion:

Document title: _____

Document number: _____ Page number: _____

If possible, please fax the referenced page or drawing.

Document Rating	Excellent	Good	Acceptable	Poor
Clarity	<input type="checkbox"/>	<input type="checkbox"/>	<input type="checkbox"/>	<input type="checkbox"/>
Technical Accuracy	<input type="checkbox"/>	<input type="checkbox"/>	<input type="checkbox"/>	<input type="checkbox"/>
Organization	<input type="checkbox"/>	<input type="checkbox"/>	<input type="checkbox"/>	<input type="checkbox"/>